

排线/电线固定座

FLAT CABLE CLAMP

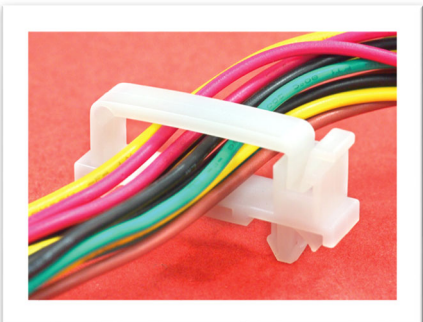

扭式固定座

TWINST LOCK

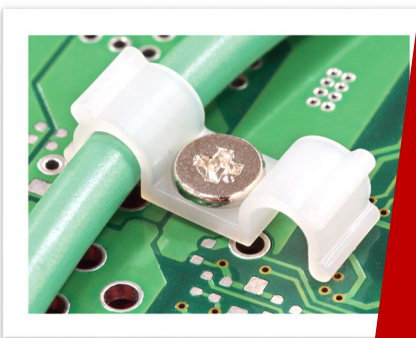

扎带固定座

CABLE TIE MOUNT



风扇束线座

FAN CABLE TIE MOUNT

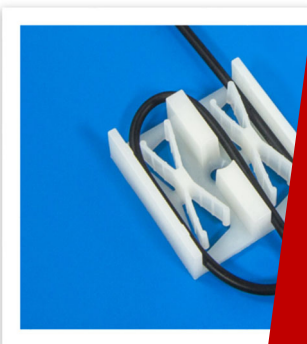

电子电脑塑胶五金零件

PLASTIC HARDWARE& ELECTRONIC COMPONENTS

2023 EDITON

排线固定座 自粘式配线固定座 排线固定夹 压线板 电线固定座 扭线固定座 扭式固定环 扎线固定座 电源线固定座 电源线固定座插头固定扣 天线固定座 T8灯管固定座 风扇束线座 光纤固定座

排线固定座 自粘式配线固定座 排线固定夹 压线板 电线固定座 扭线固定座 扭式固定环 扎线固定座 电源线固定座 电源线固定座插头固定扣 天线固定座 T8灯管固定座 风扇束线座 光纤固定座

排线固定座

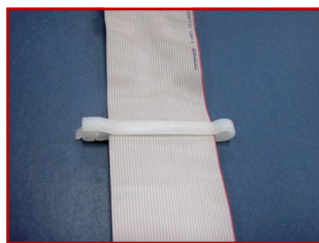
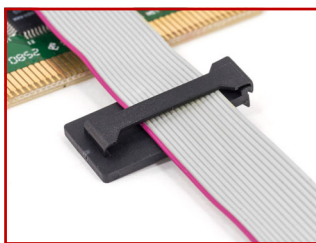
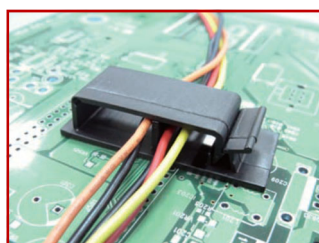
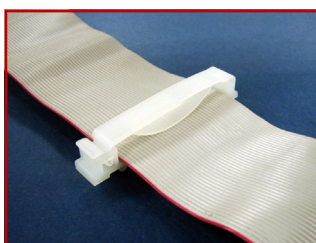
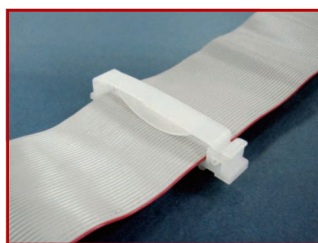
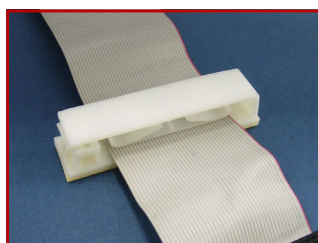
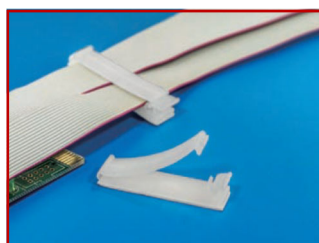
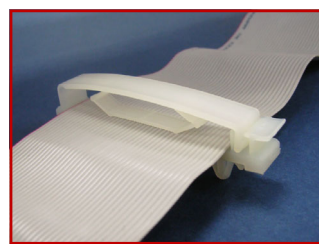
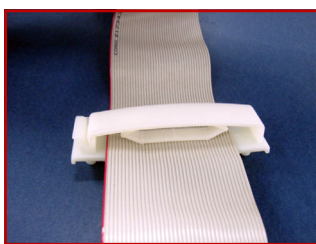
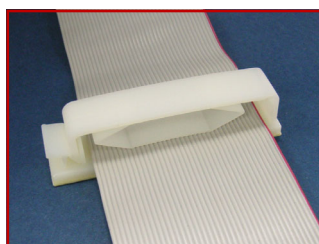
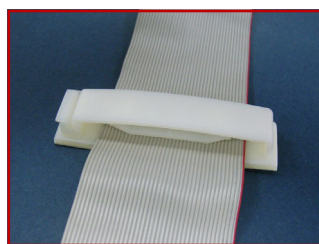

排线固定座 自粘式配线固定座 排线固定夹 压线板 电线固定座 扭线固定座 扭式固定环 扎线固定座 电源线固定座 电源线固定座插头固定扣 天线固定座 T8灯管固定座 风扇束线座 光纤固定座

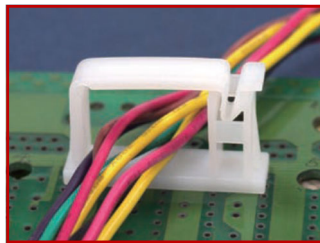
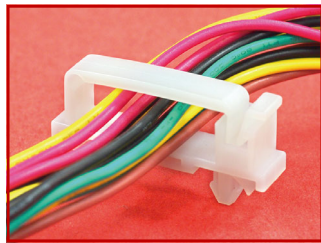
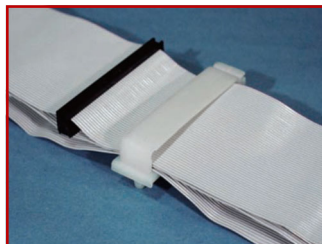
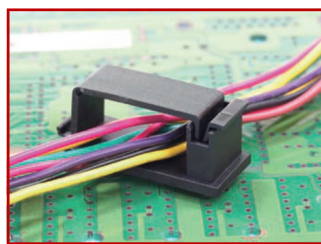
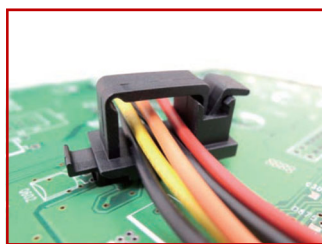
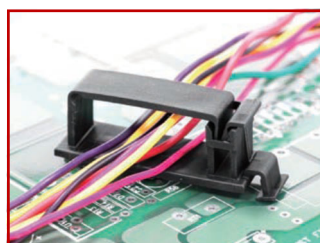
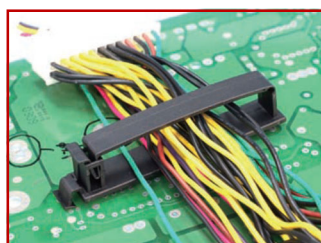
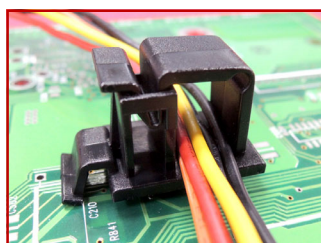
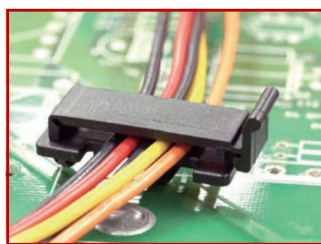
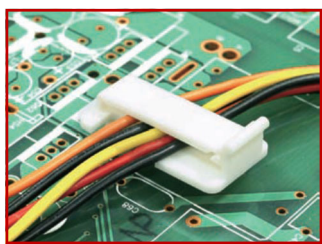
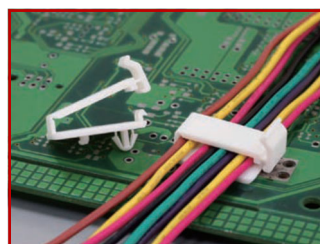
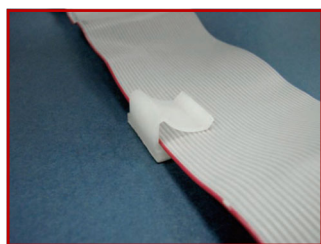

排线固定座

排线固定座 自粘式配线固定座 排线固定夹 压线板 电线固定座 扭线固定座 扭式固定环 扎线固定座 电源线固定座 电源线固定座插头固定扣 天线固定座 T8灯管固定座 风扇束线座 光纤固定座

排线固定座

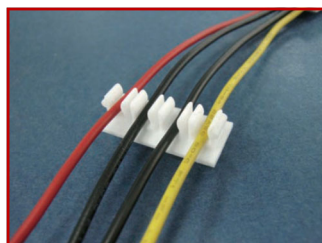
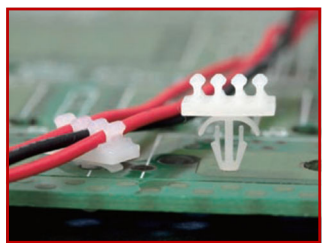
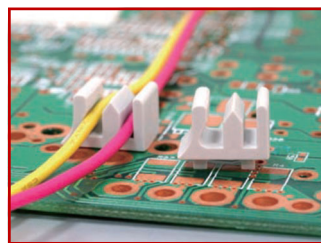
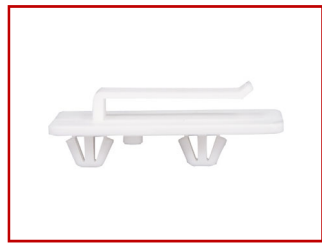
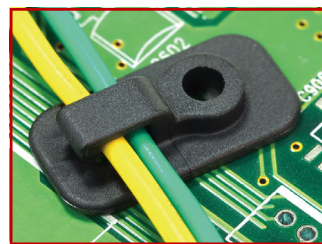
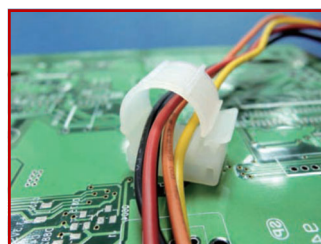
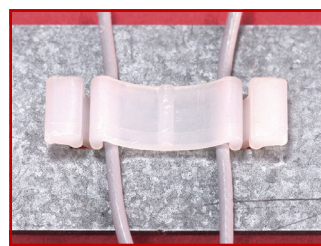
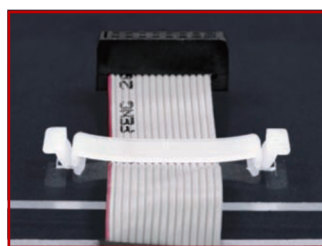

排线固定座 自粘式配线固定座 排线固定夹 压线板 电线固定座 扭线固定座 扭式固定环 扎线固定座 电源线固定座 电源线固定座插头固定扣 天线固定座 T8灯管固定座 风扇束线座 光纤固定座

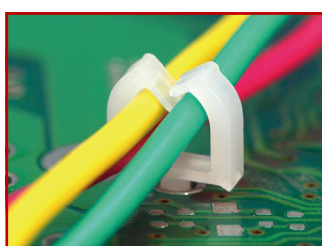
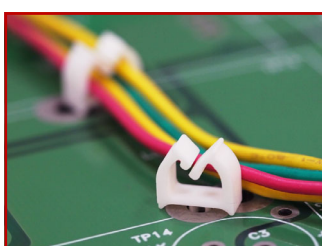
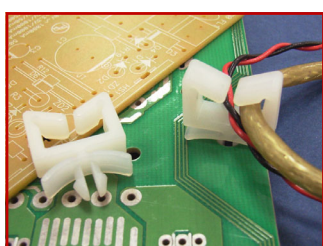
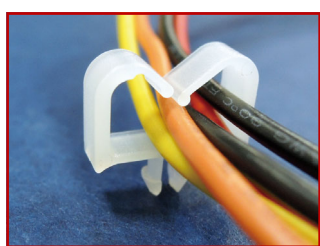
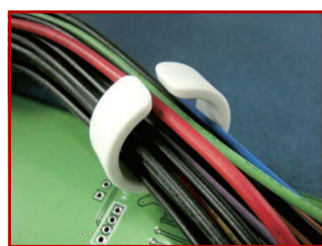
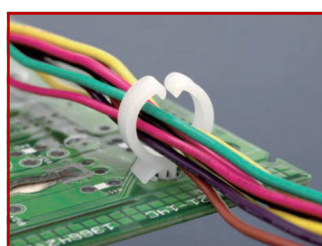
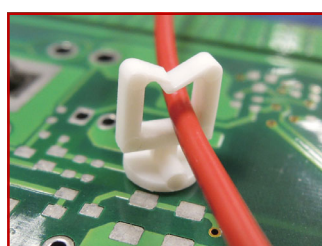
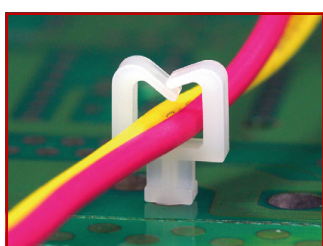
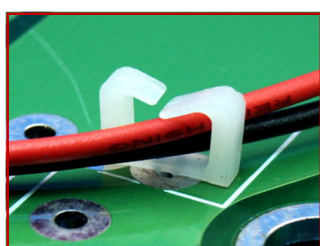
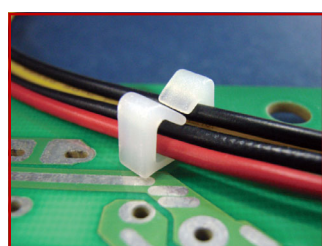
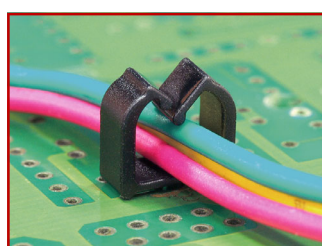
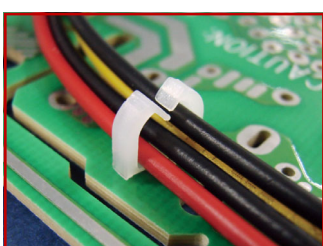
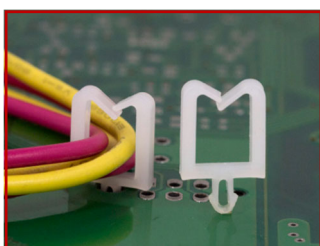
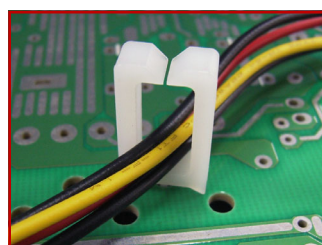
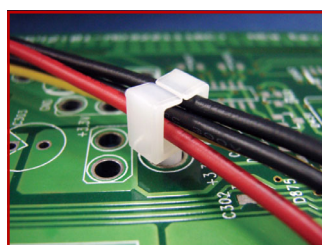
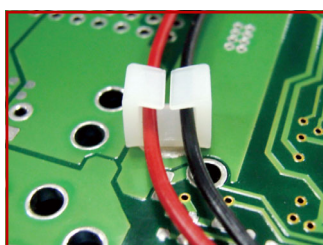
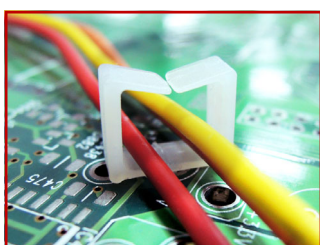
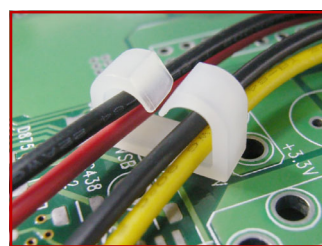
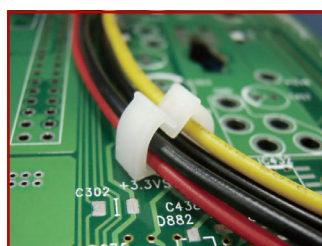
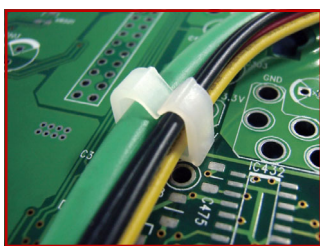
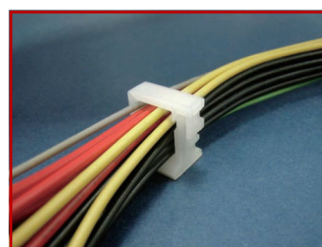
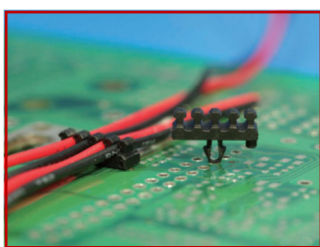

排线固定座

排线固定座 自粘式配线固定座 排线固定夹 压线板 电线固定座 扭线固定座 扭式固定环 扎线固定座 电源线固定座 电源线固定座插头固定扣 天线固定座 T8灯管固定座 风扇束线座 光纤固定座

排线固定座

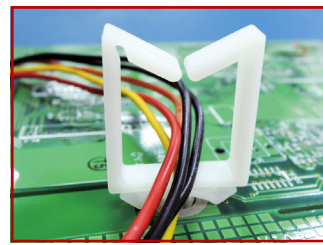
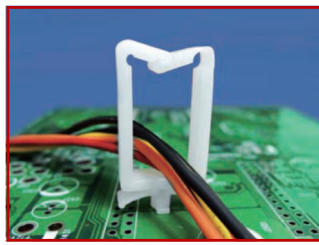
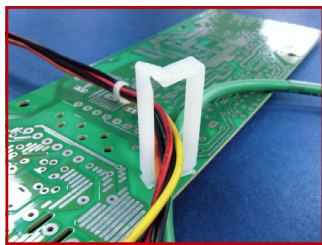
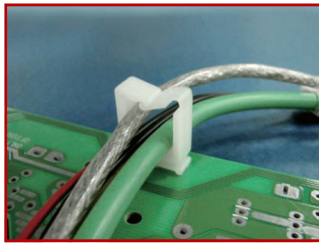
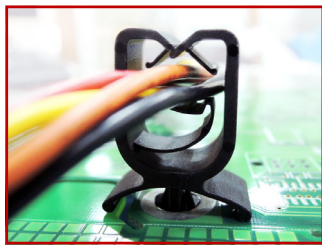
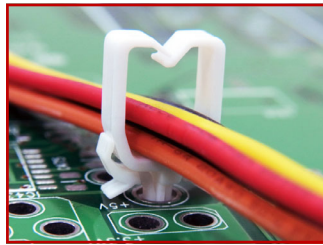
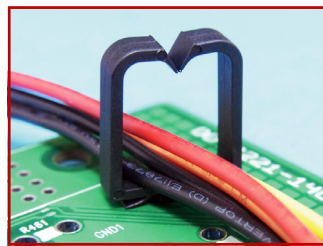
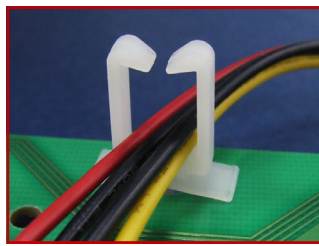
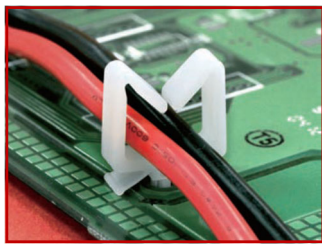
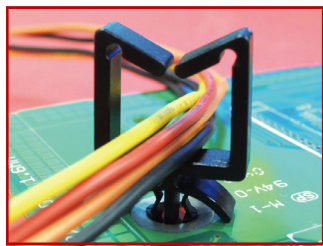
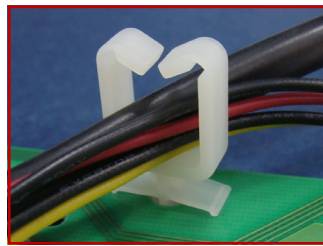
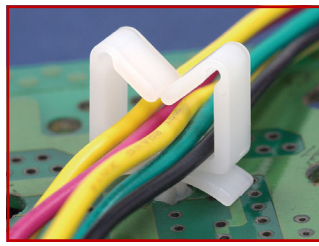
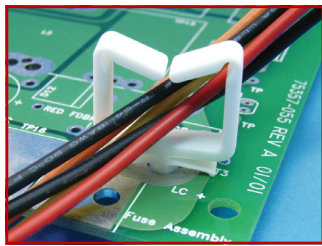
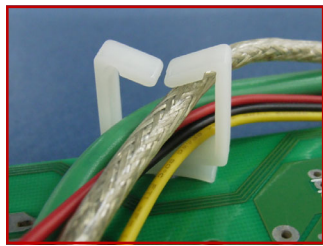
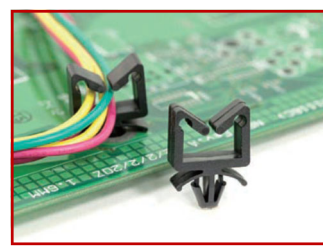
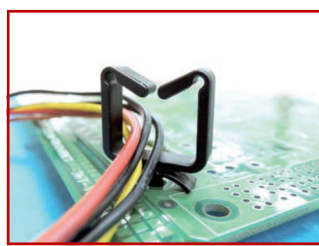
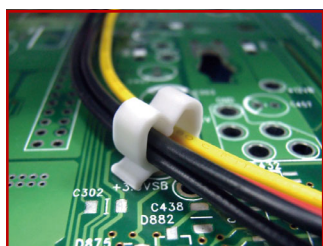
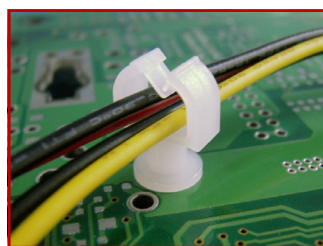
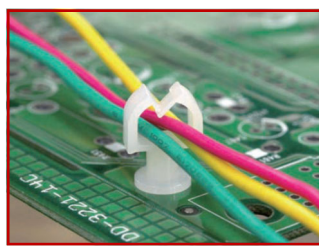
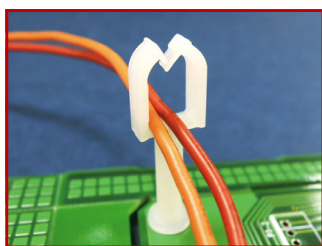
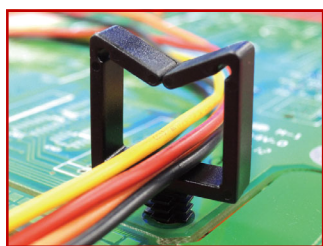
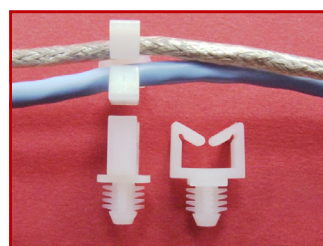
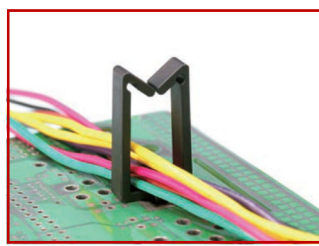
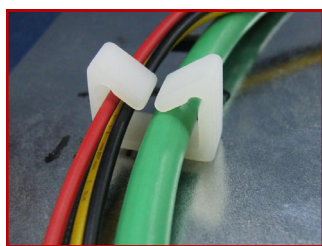
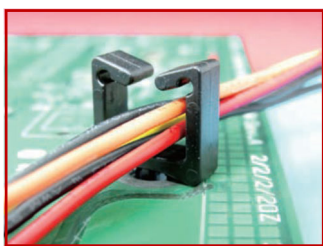

排线固定座 自粘式配线固定座 排线固定夹 压线板 电线固定座 扭线固定座 扭式固定环 扎线固定座 电源线固定座 电源线固定座插头固定扣 天线固定座 T8灯管固定座 风扇束线座 光纤固定座

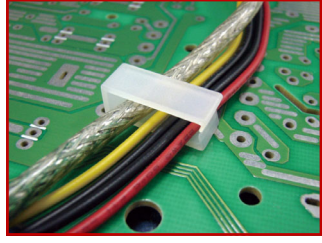
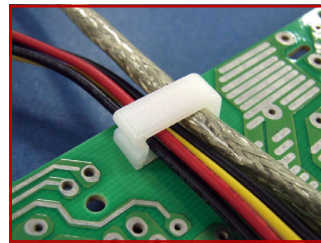
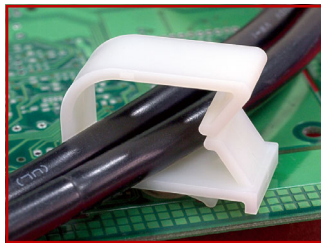
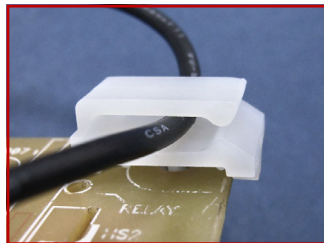
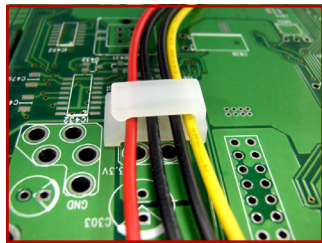
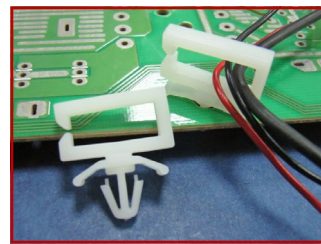
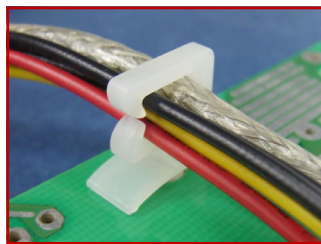
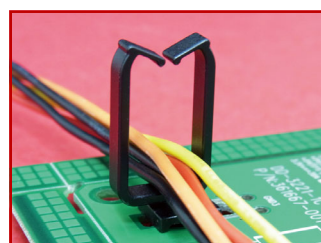
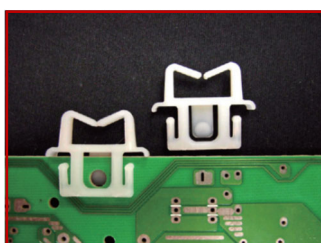
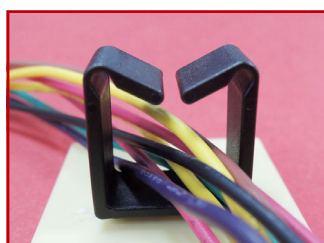
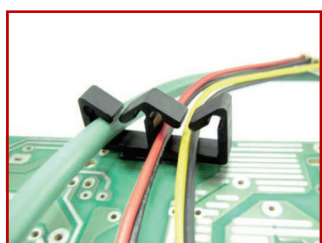
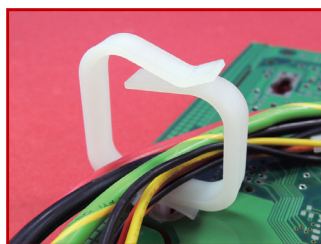
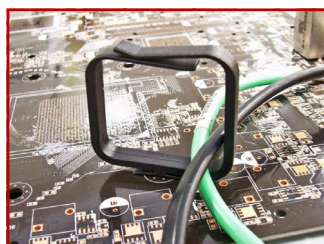
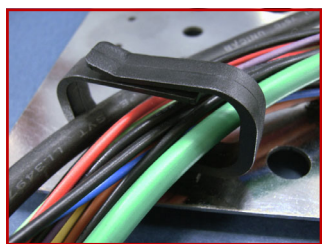
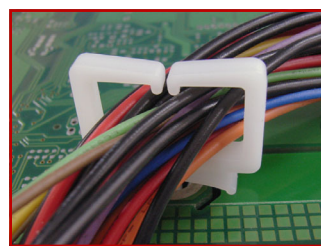
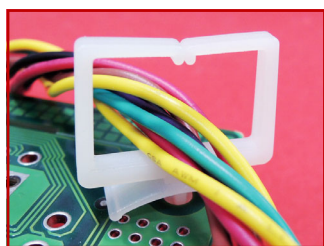
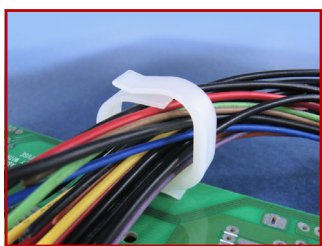

排线固定座

排线固定座 自粘式配线固定座 排线固定夹 压线板 电线固定座 扭线固定座 扭式固定环 扎线固定座 电源线固定座 电源线固定座插头固定扣 天线固定座 T8灯管固定座 风扇束线座 光纤固定座

排线固定座

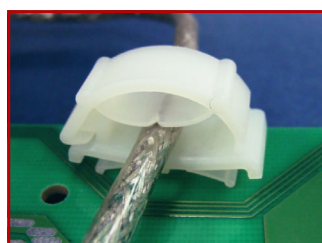
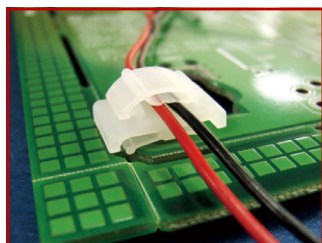
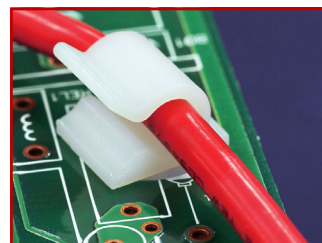
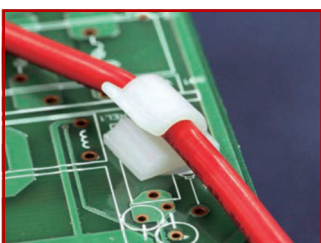
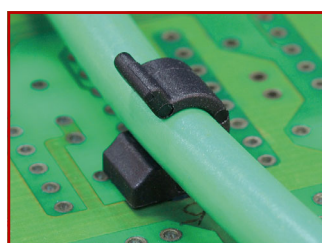
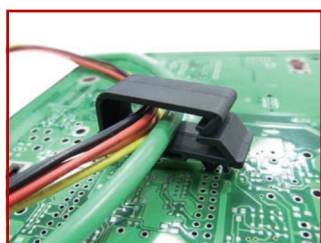
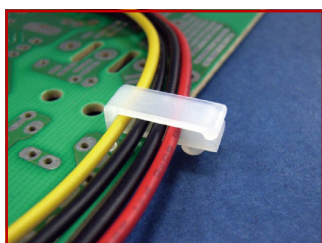
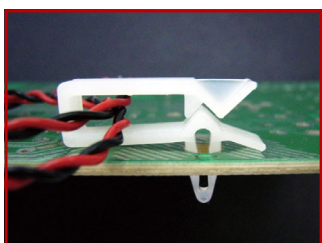
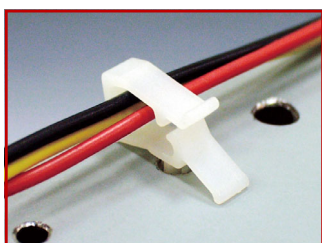
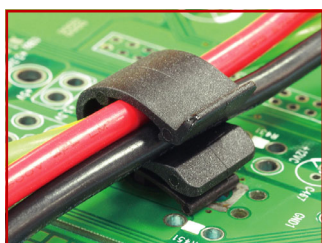
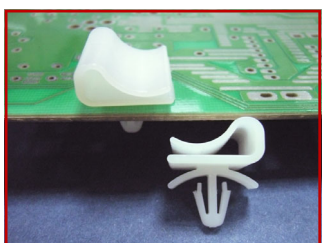
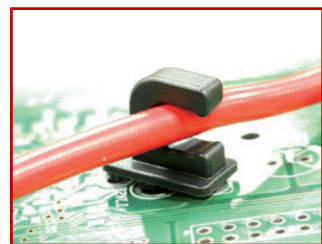
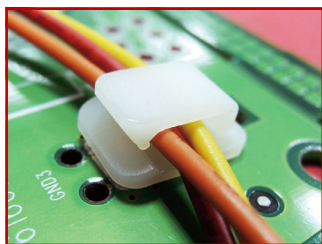
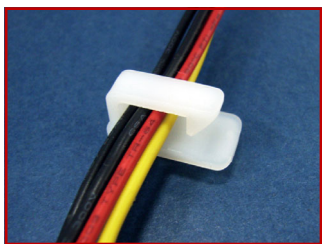
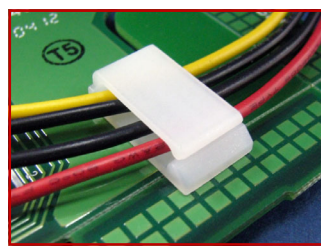
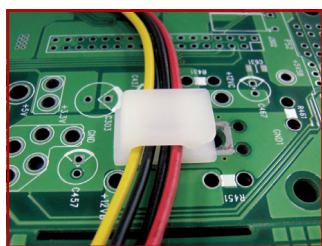
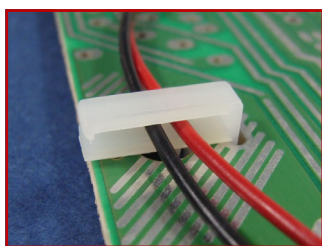
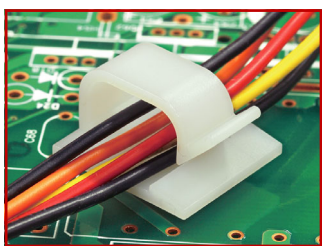

排线固定座 自粘式配线固定座 排线固定夹 压线板 电线固定座 扭线固定座 扭式固定环 扎线固定座 电源线固定座 电源线固定座插头固定扣 天线固定座 T8灯管固定座 风扇束线座 光纤固定座

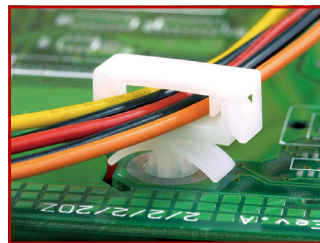
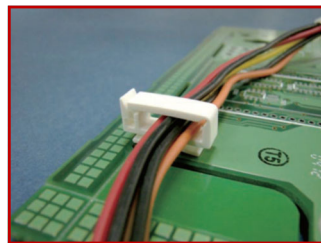
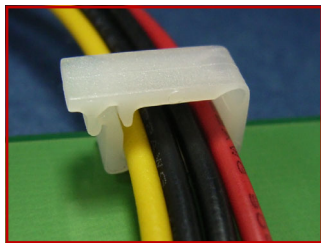
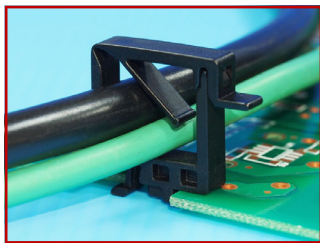
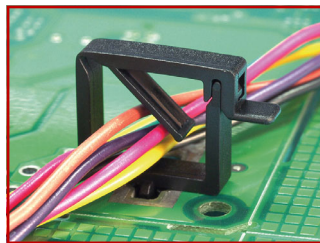
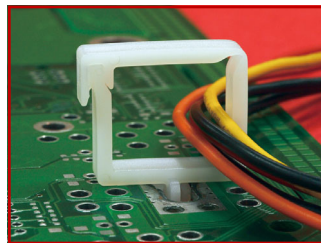
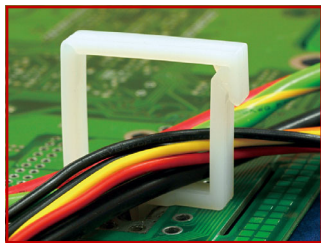
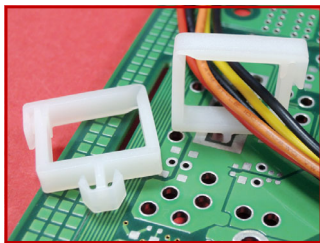
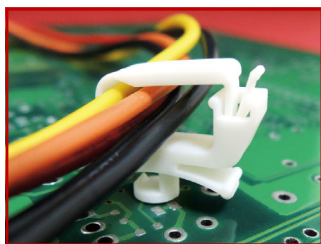
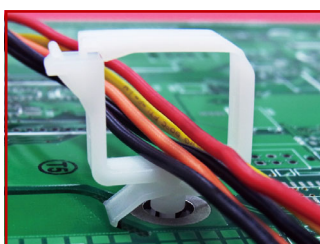
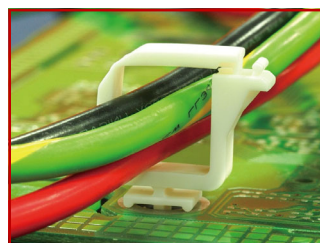
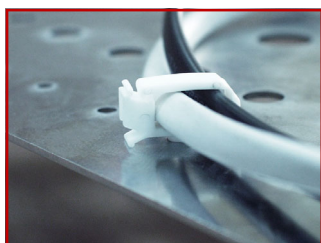
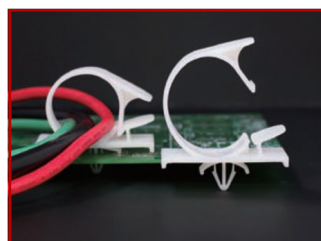
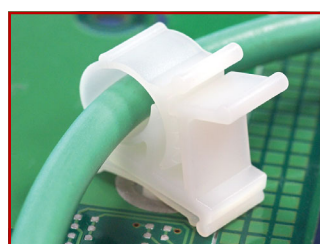
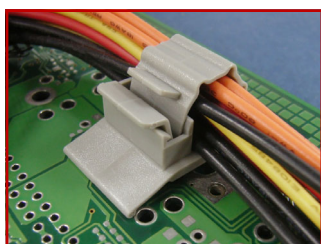
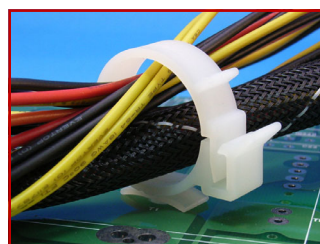
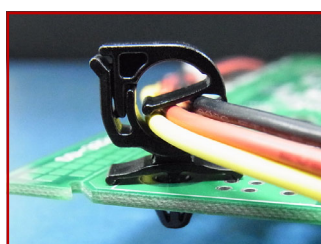
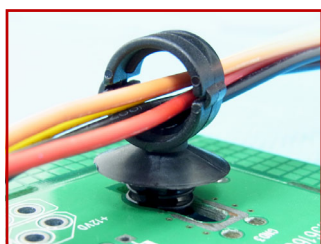
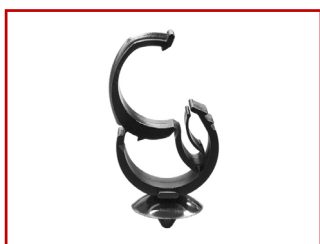

排线固定座

排线固定座 自粘式配线固定座 排线固定夹 压线板 电线固定座 扭线固定座 扭式固定环 扎线固定座 电源线固定座 电源线固定座插头固定扣 天线固定座 T8灯管固定座 风扇束线座 光纤固定座

排线固定座

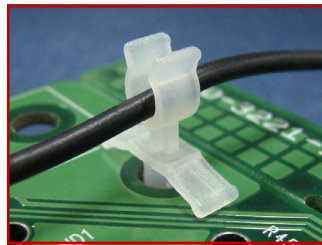
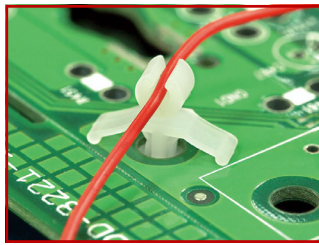
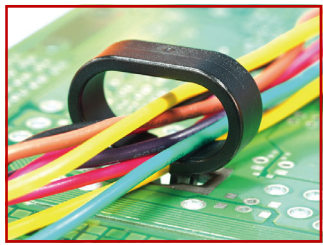
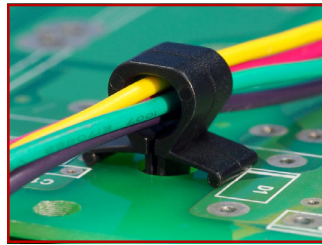
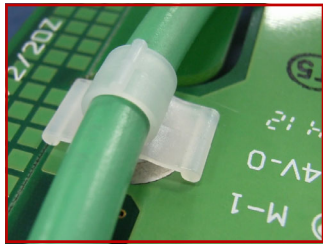
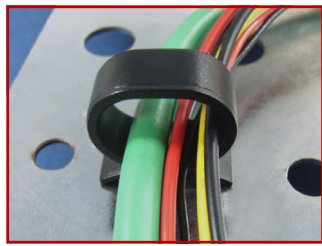
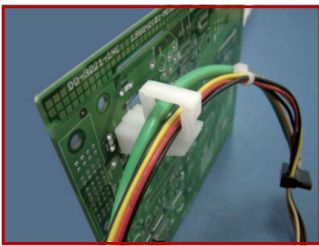
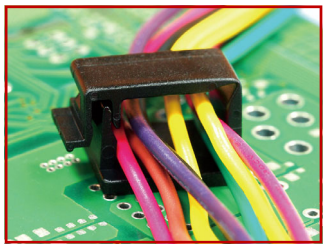
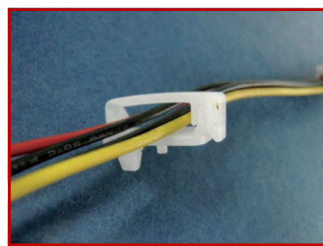
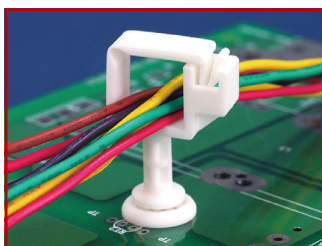
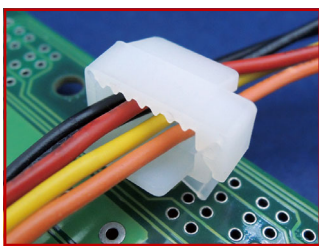
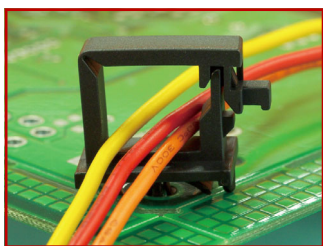
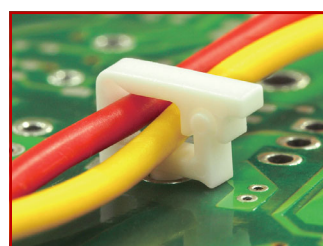
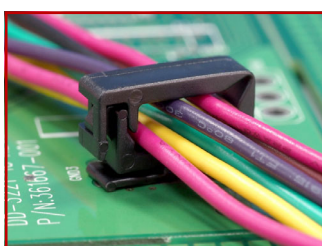
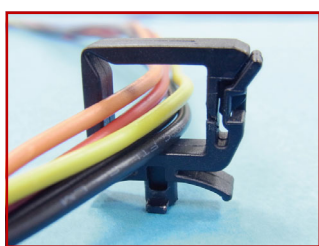
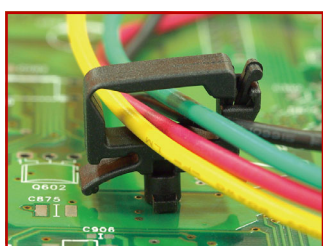
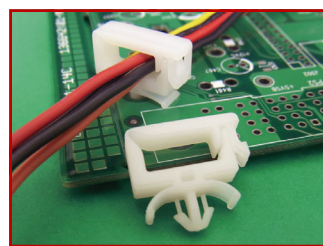
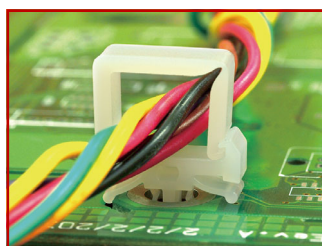
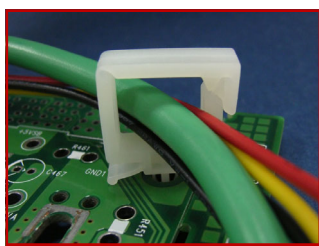
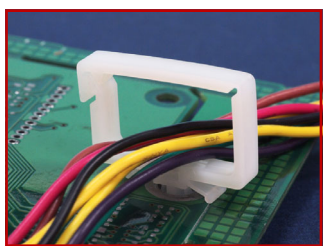
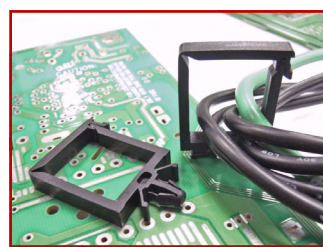
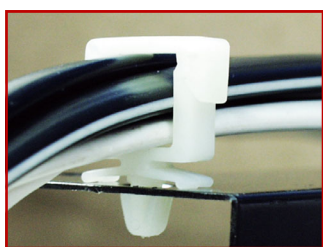

排线固定座 自粘式配线固定座 排线固定夹 压线板 电线固定座 扭线固定座 扭式固定环 扎线固定座 电源线固定座 电源线固定座插头固定扣 天线固定座 T8灯管固定座 风扇束线座 光纤固定座

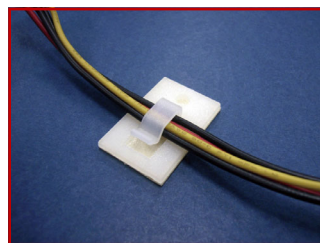
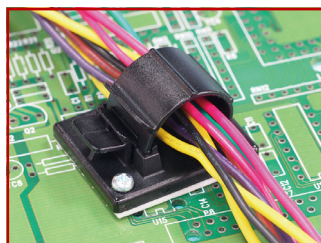
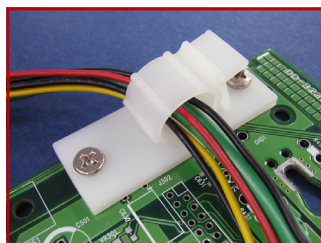
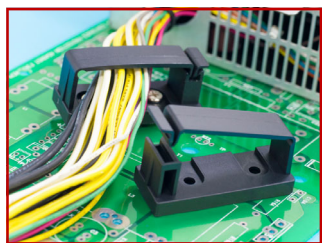
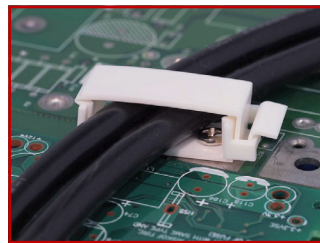
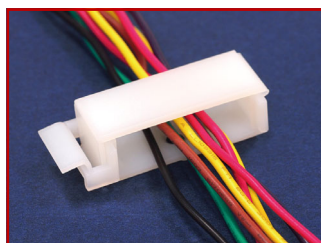
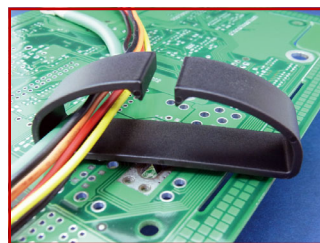
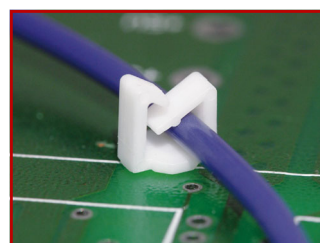
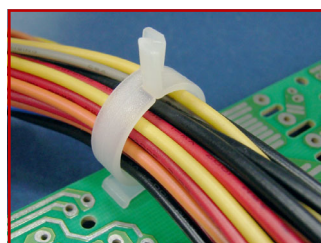
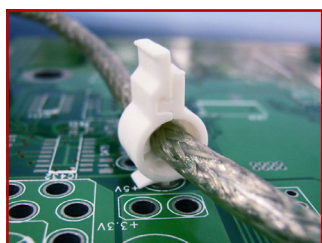
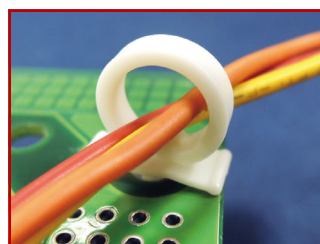
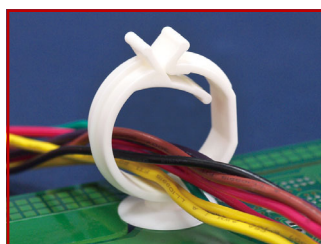
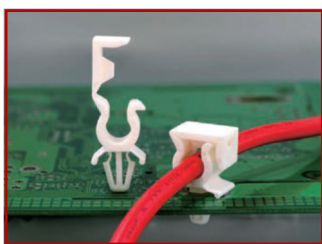
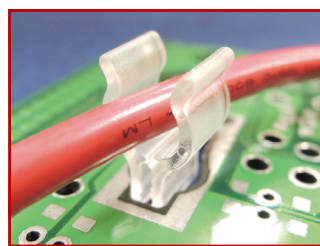
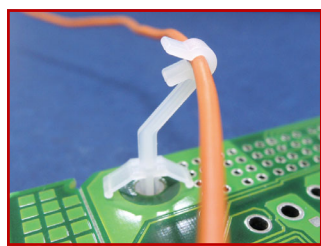
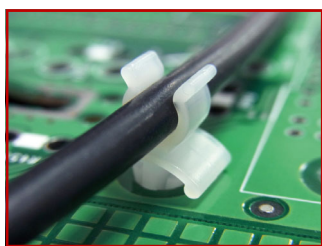

排线固定座

排线固定座 自粘式配线固定座 排线固定夹 压线板 电线固定座 扭线固定座 扭式固定环 扎线固定座 电源线固定座 电源线固定座插头固定扣 天线固定座 T8灯管固定座 风扇束线座 光纤固定座

排线固定座

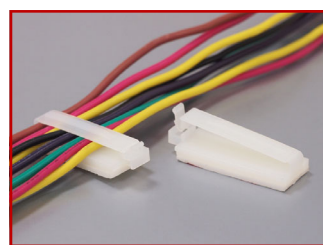
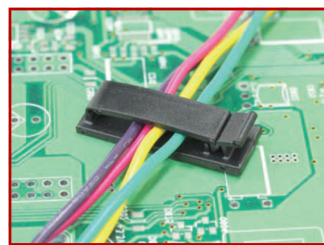
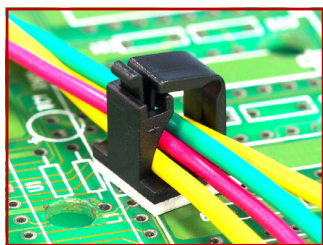
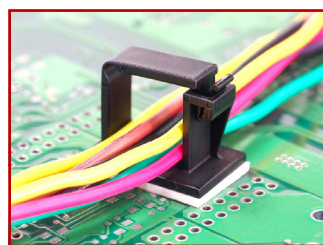
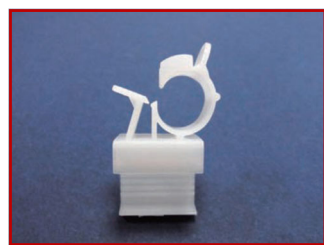
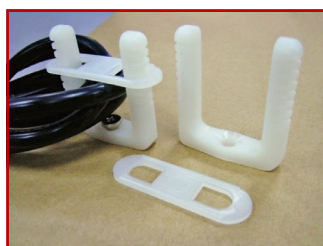
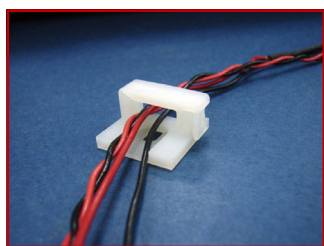
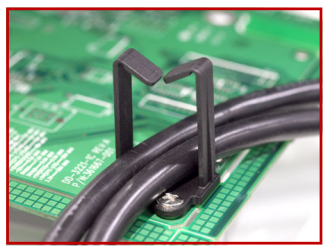
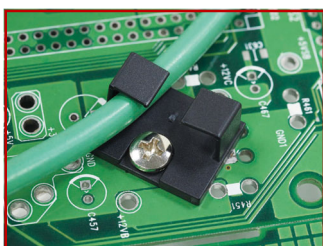
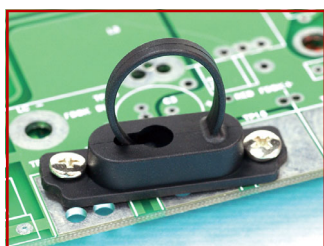
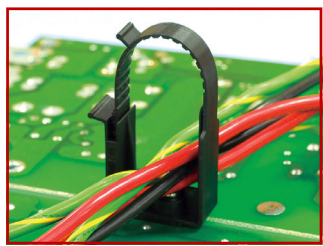
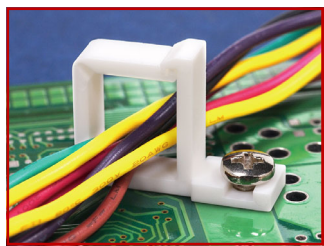
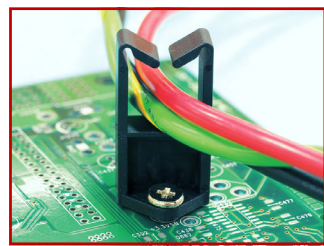
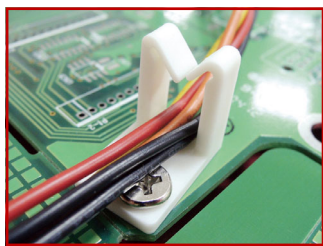
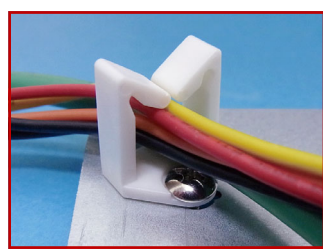
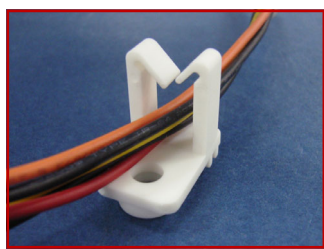
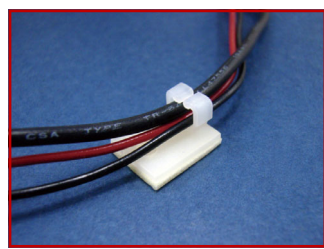
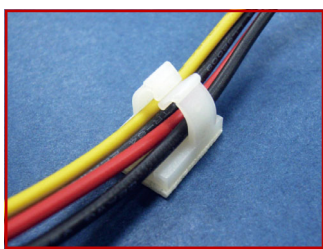
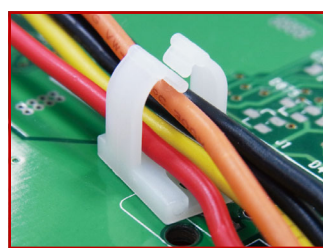
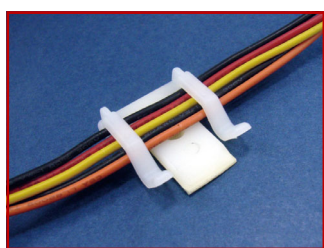
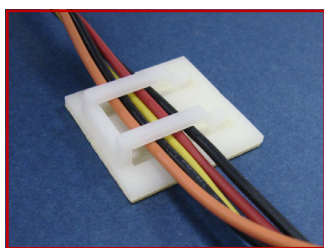
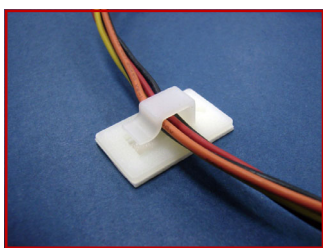

排线固定座 自粘式配线固定座 排线固定夹 压线板 电线固定座 扭线固定座 扭式固定环 扎线固定座 电源线固定座 电源线固定座插头固定扣 天线固定座 T8灯管固定座 风扇束线座 光纤固定座

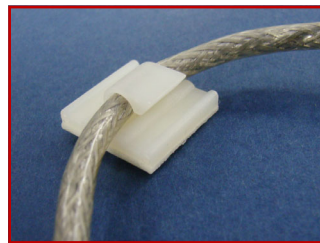
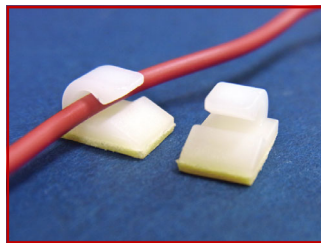
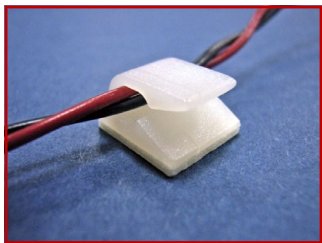
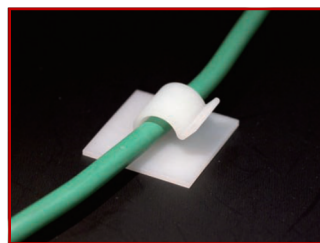
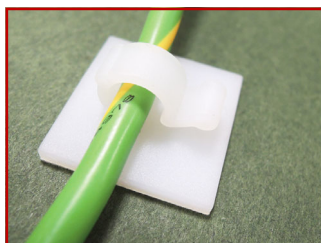
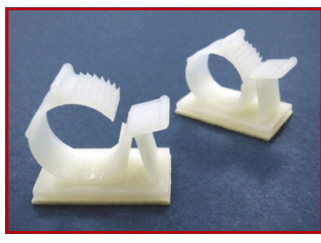
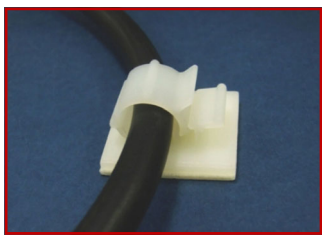
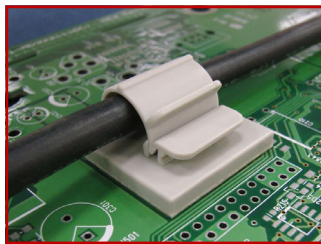
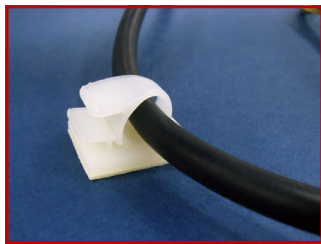
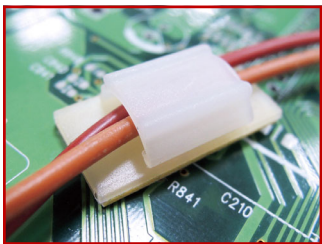
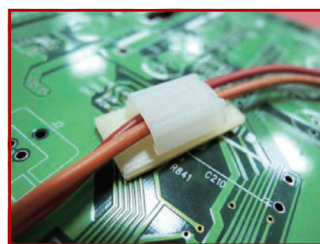
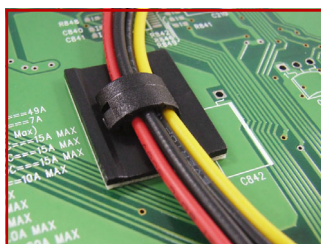
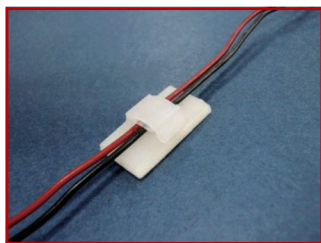
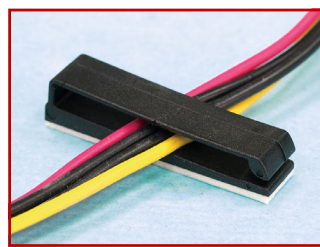
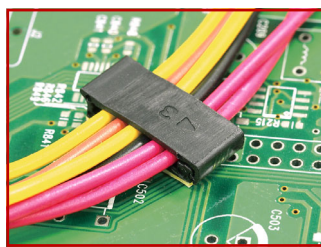
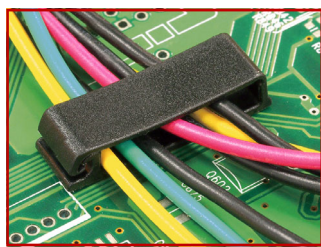
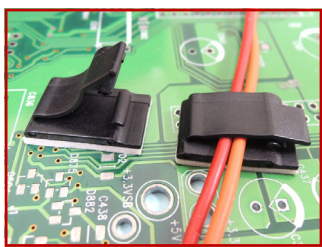
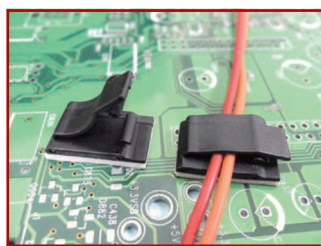
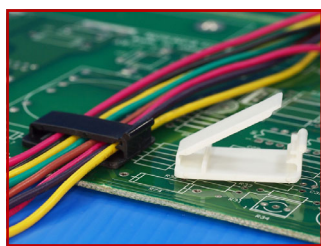
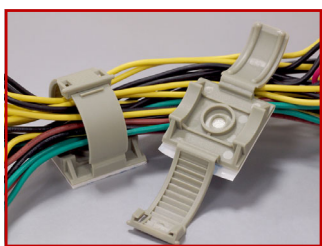

排线固定座

排线固定座 自粘式配线固定座 排线固定夹 压线板 电线固定座 扭线固定座 扭式固定环 扎线固定座 电源线固定座 电源线固定座插头固定扣 天线固定座 T8灯管固定座 风扇束线座 光纤固定座

排线固定座

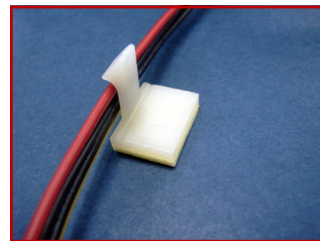
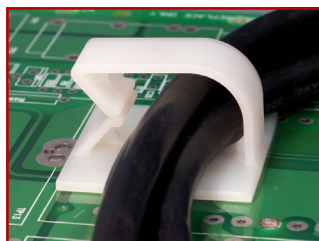
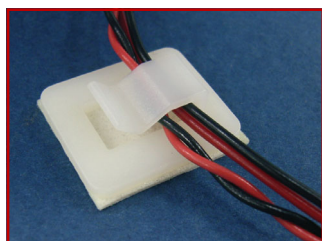
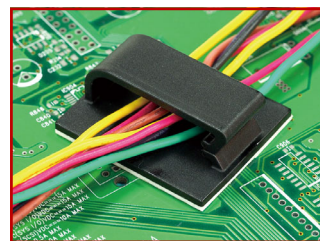
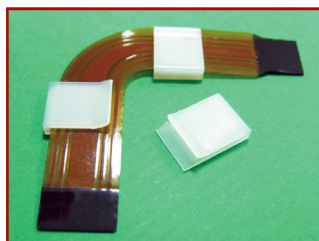
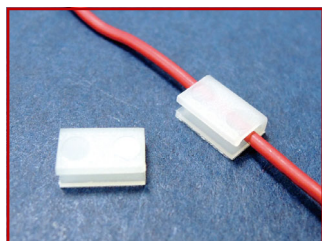
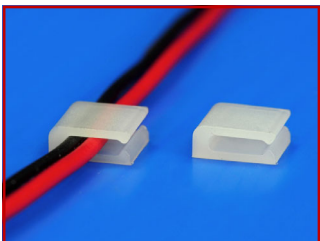
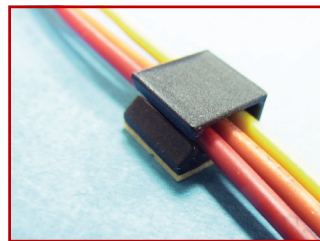
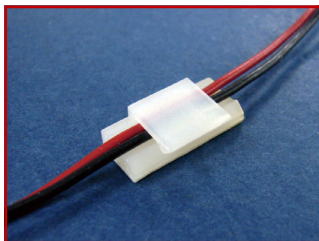
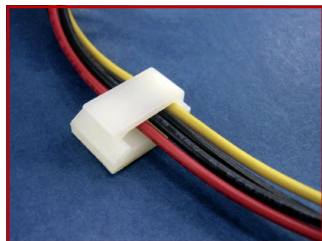
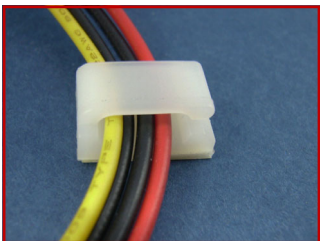
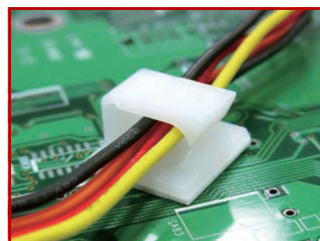
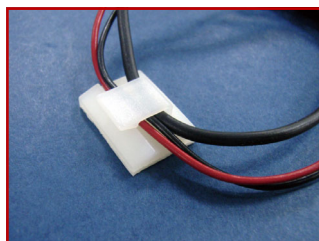
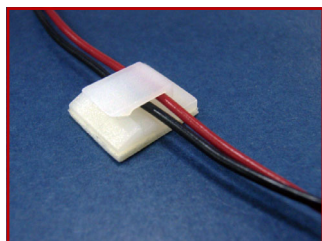
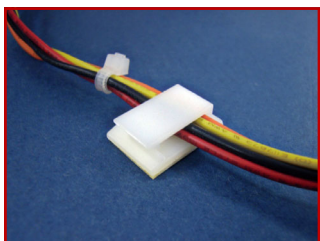
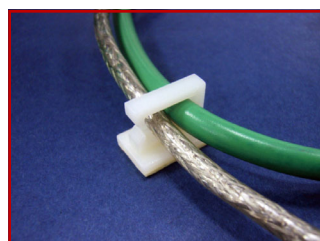
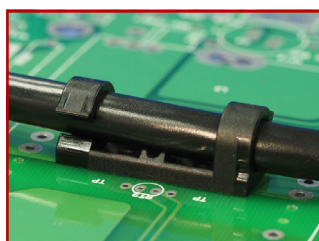
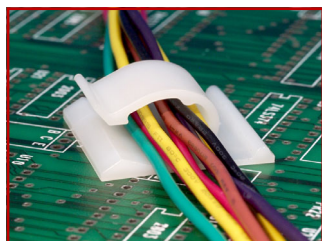
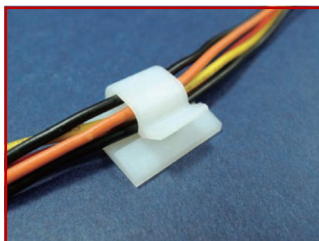
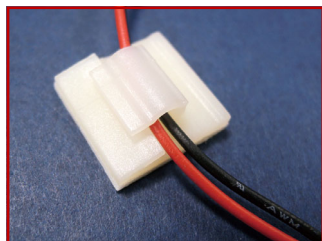
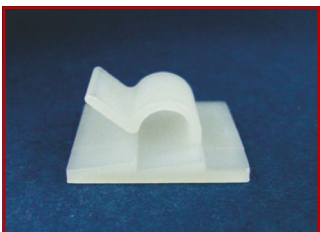
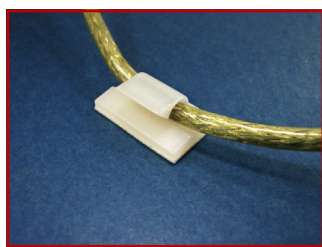
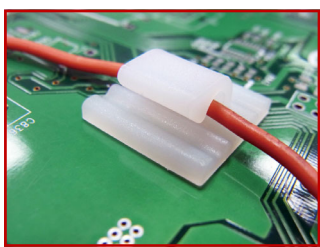

排线固定座 自粘式配线固定座 排线固定夹 压线板 电线固定座 扭线固定座 扭式固定环 扎线固定座 电源线固定座 电源线固定座插头固定扣 天线固定座 T8灯管固定座 风扇束线座 光纤固定座

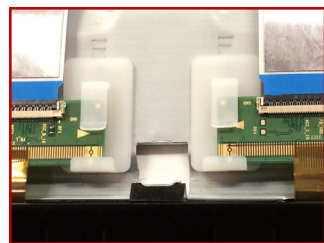
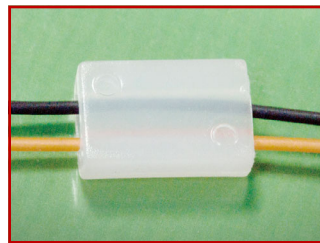
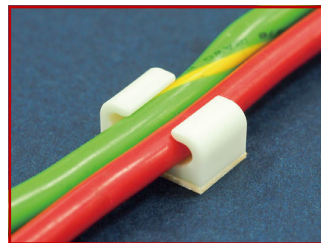
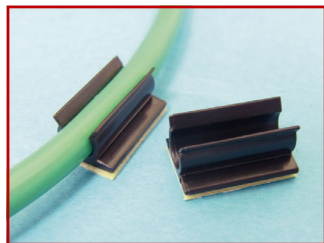
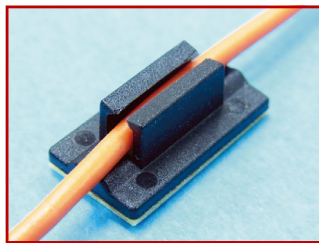
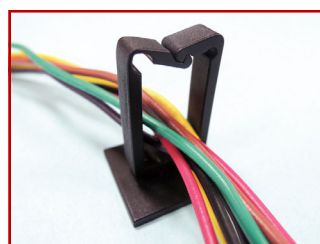
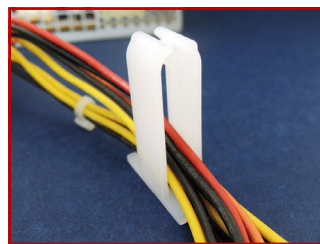
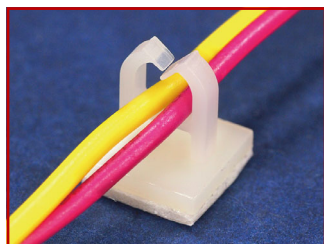
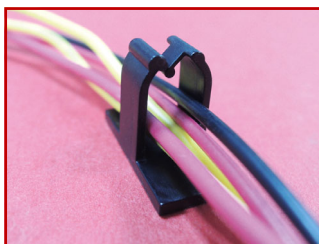
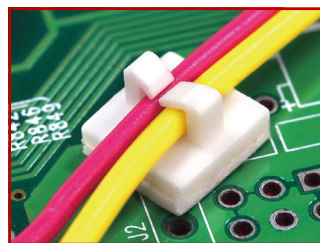
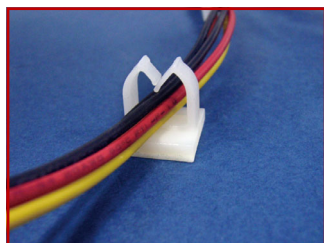
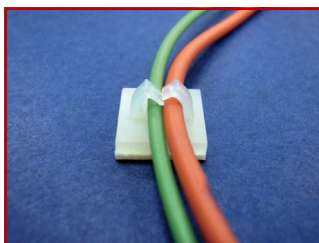
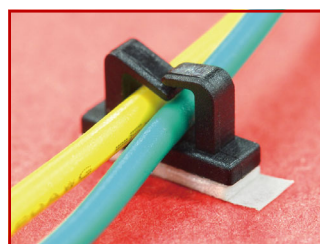
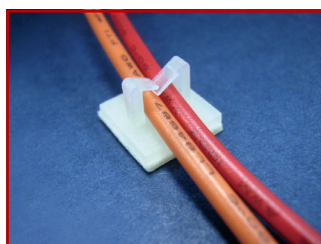
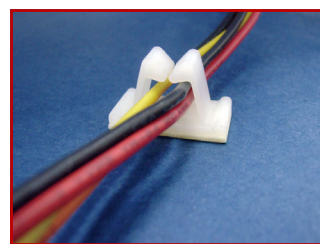
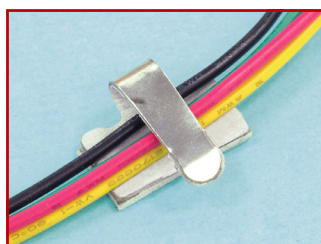

排线固定座

排线固定座 自粘式配线固定座 排线固定夹 压线板 电线固定座 扭线固定座 扭式固定环 扎线固定座 电源线固定座 电源线固定座插头固定扣 天线固定座 T8灯管固定座 风扇束线座 光纤固定座

排线固定座

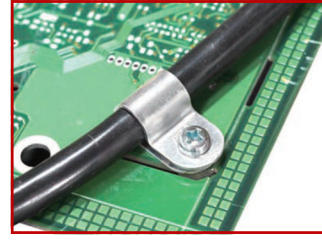
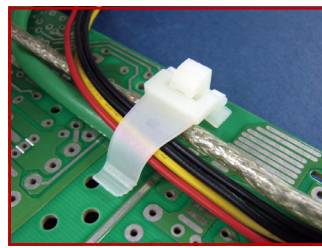
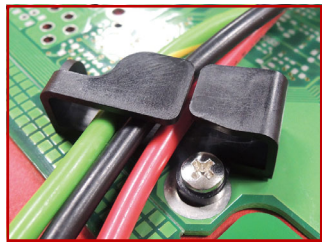
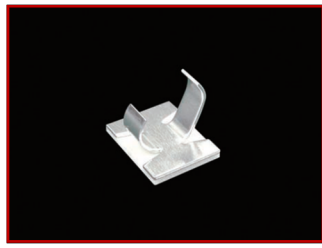
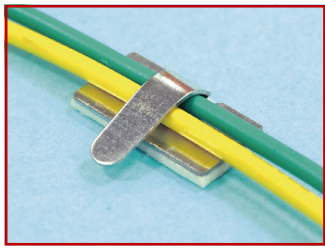
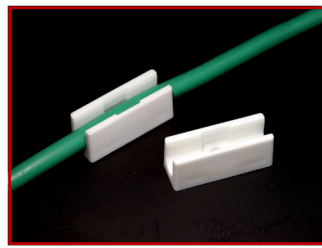
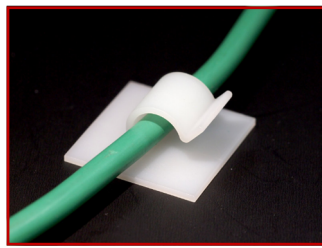
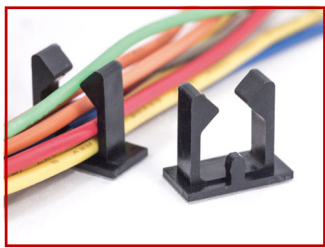
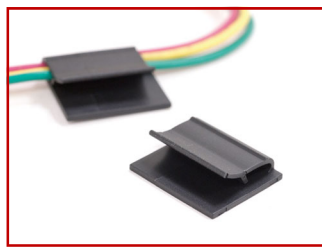
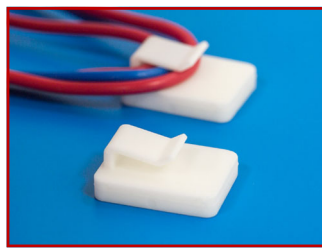
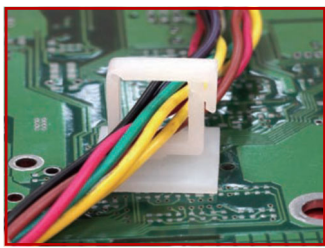
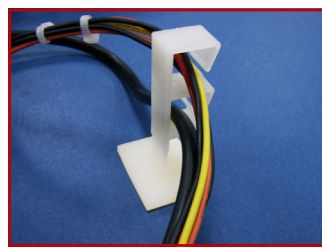
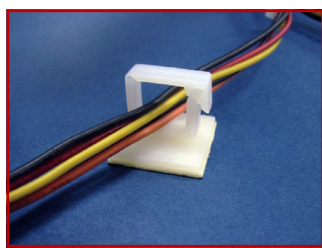
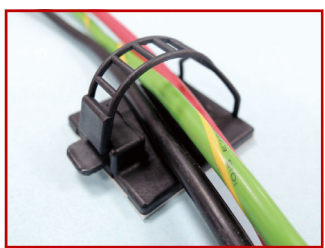
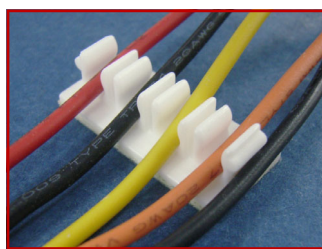
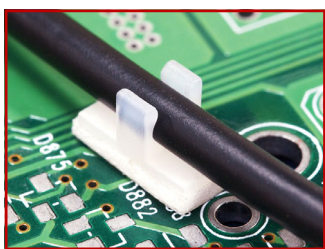
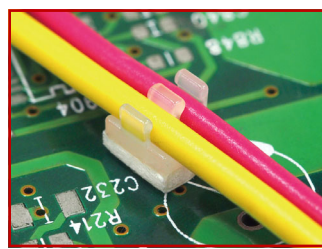
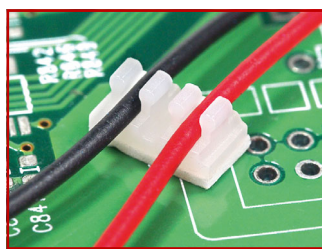
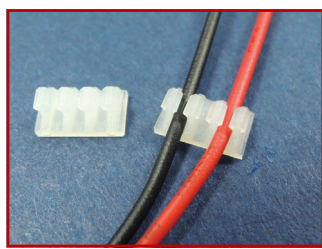
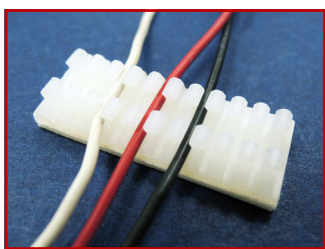

排线固定座 自粘式配线固定座 排线固定夹 压线板 电线固定座 扭线固定座 扭式固定环 扎线固定座 电源线固定座 电源线固定座插头固定扣 天线固定座 T8灯管固定座 风扇束线座 光纤固定座

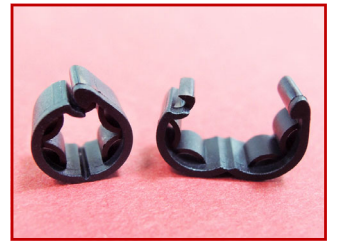
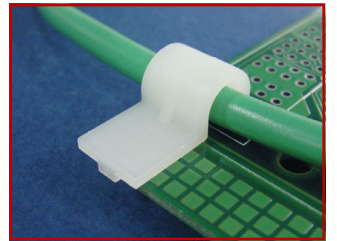
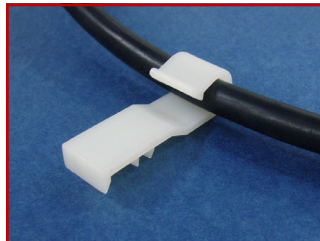
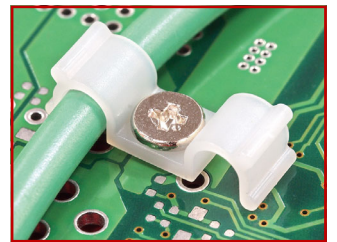
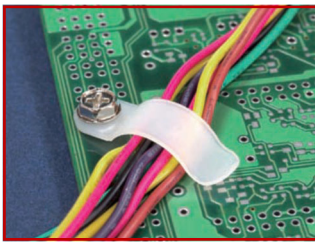
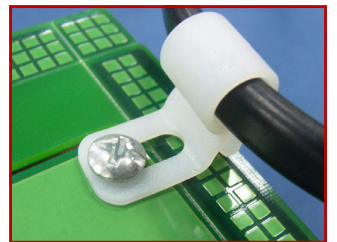
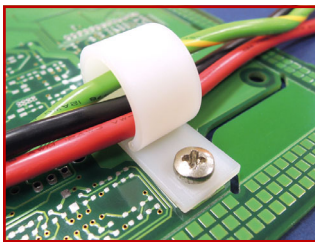
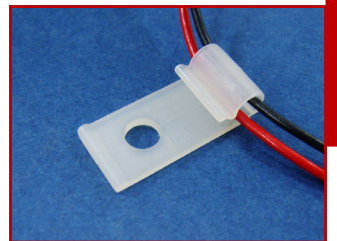
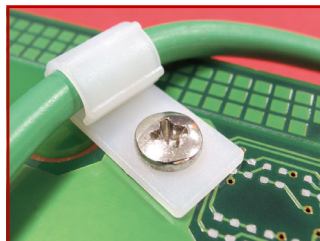
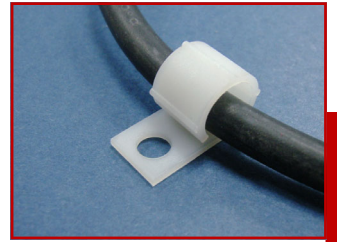
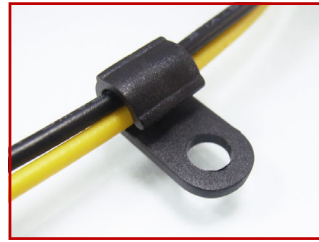
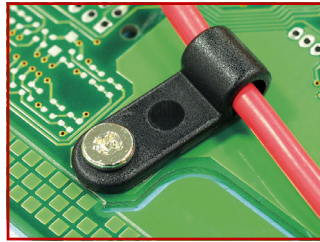
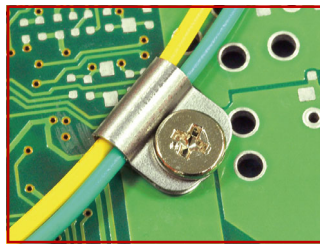
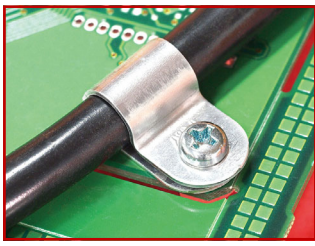

排线固定座

排线固定座 自粘式配线固定座 排线固定夹 压线板 电线固定座 扭线固定座 扭式固定环 扎线固定座 电源线固定座 电源线固定座插头固定扣 天线固定座 T8灯管固定座 风扇束线座 光纤固定座

排线固定座

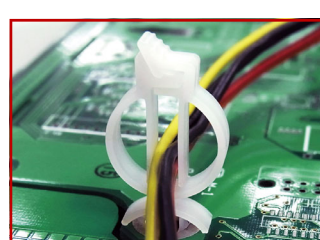
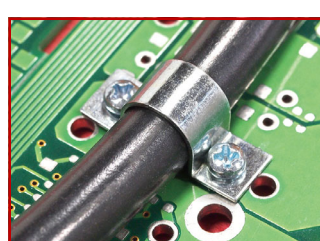
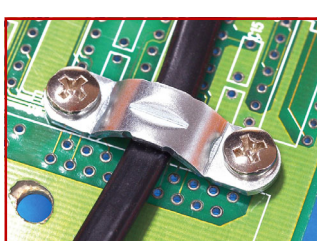
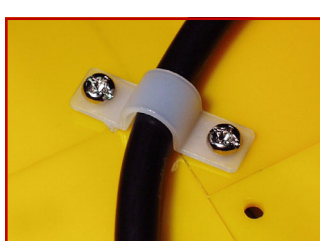
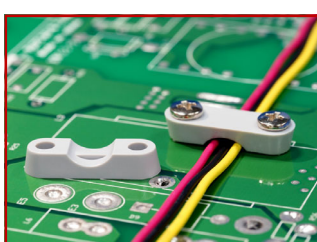
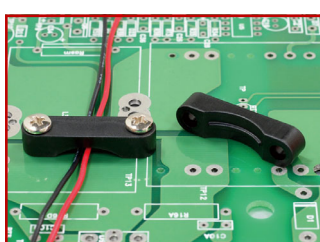
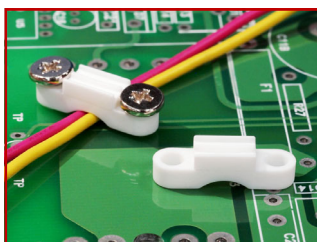
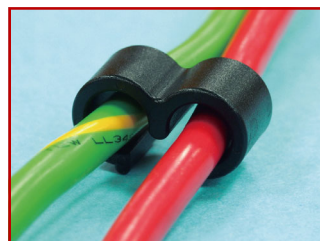
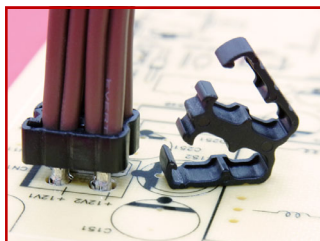

排线固定座 自粘式配线固定座 排线固定夹 压线板 电线固定座 扭线固定座 扭式固定环 扎线固定座 电源线固定座 电源线固定座插头固定扣 天线固定座 T8灯管固定座 风扇束线座 光纤固定座

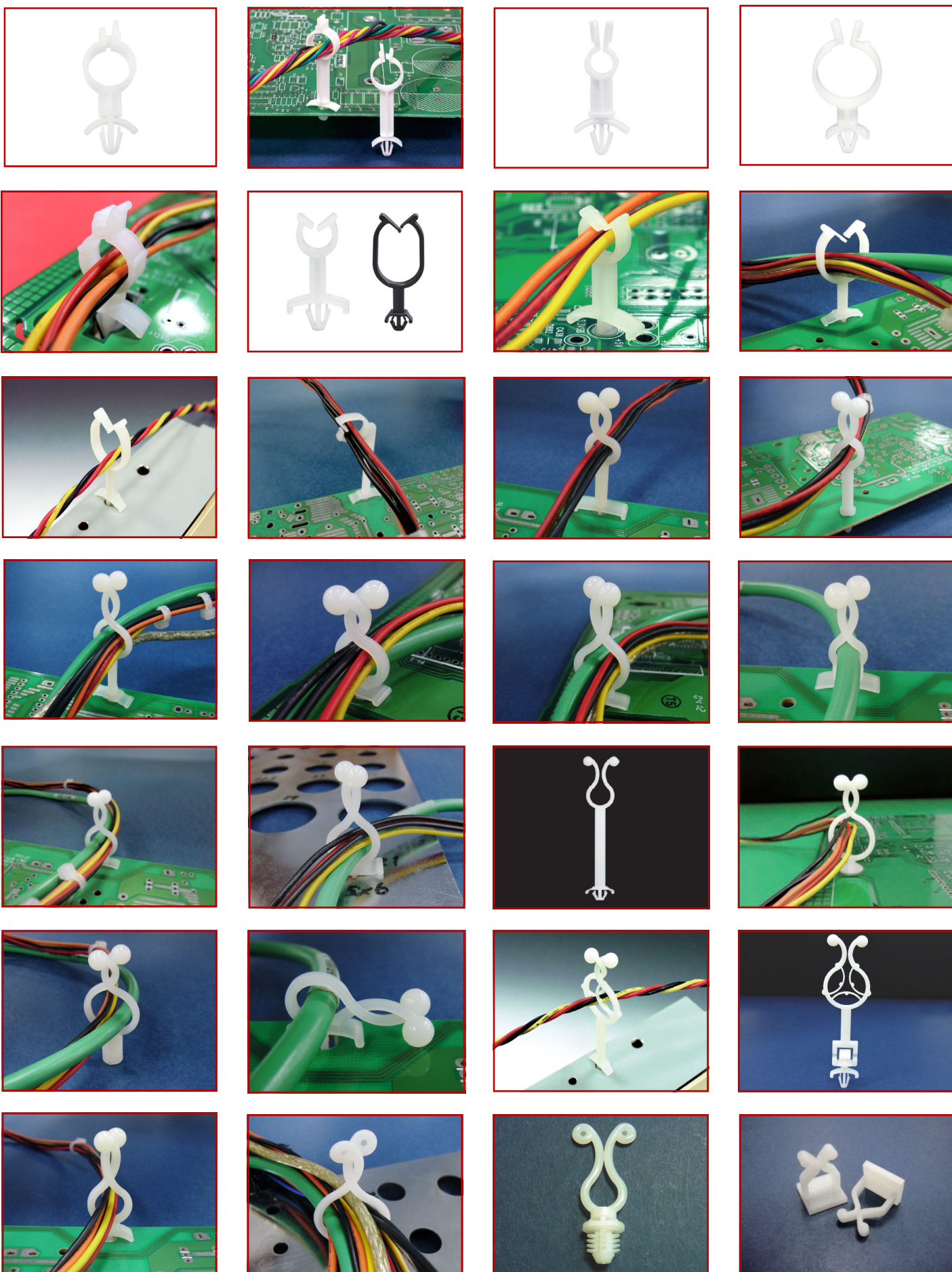

排线固定座

排线固定座 自粘式配线固定座 排线固定夹 压线板 电线固定座 扭线固定座 扭式固定环 扎线固定座 电源线固定座 电源线固定座插头固定扣 天线固定座 T8灯管固定座 风扇束线座 光纤固定座

排线固定座

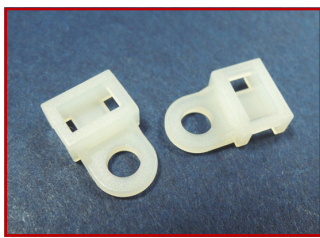
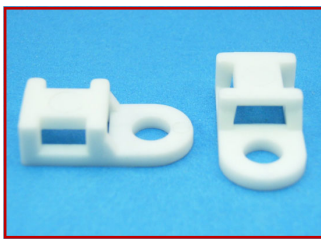
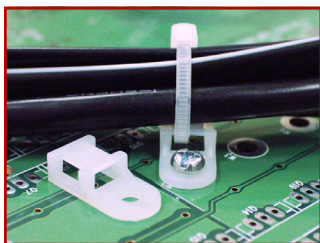
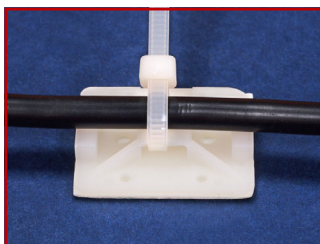
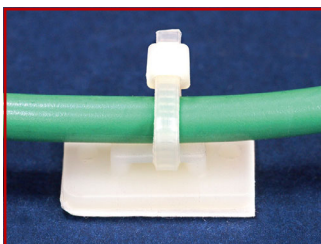
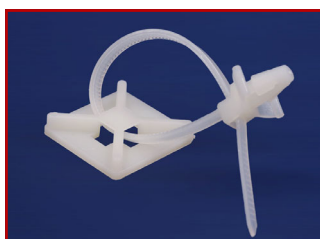
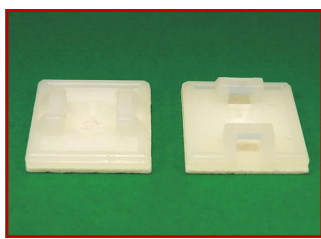
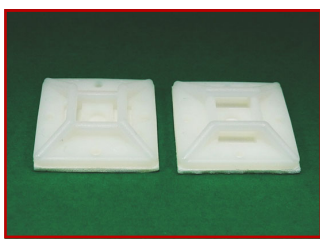
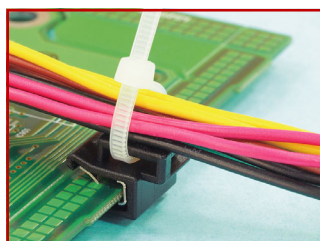
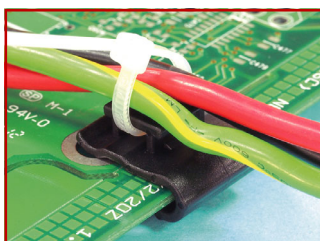
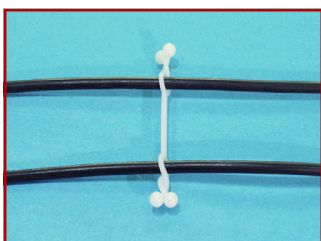
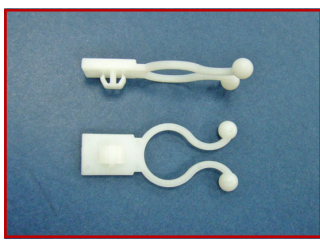
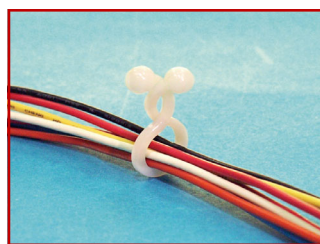
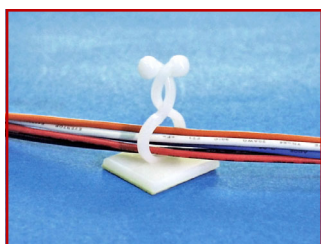
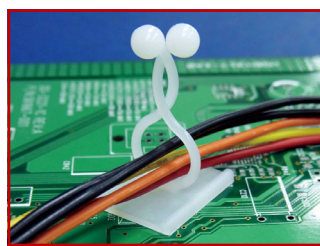
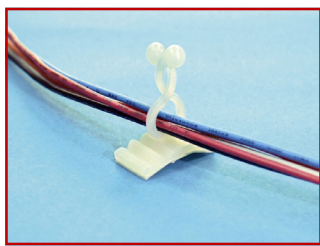
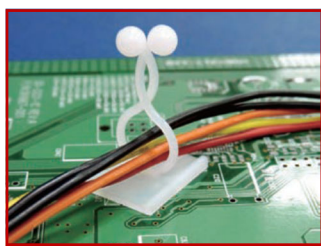
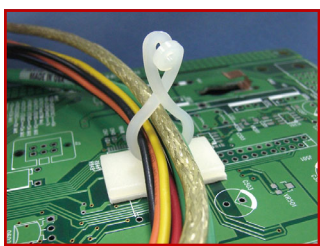

排线固定座 自粘式配线固定座 排线固定夹 压线板 电线固定座 扭线固定座 扭式固定环 扎线固定座 电源线固定座 电源线固定座插头固定扣 天线固定座 T8灯管固定座 风扇束线座 光纤固定座

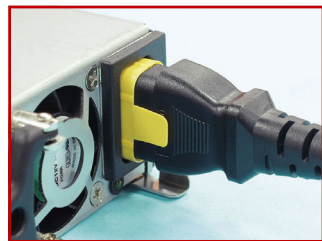
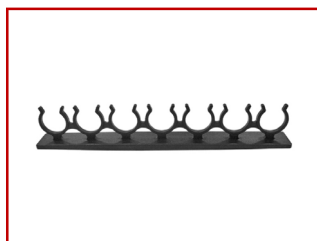
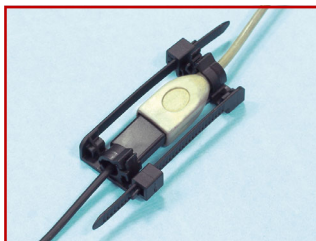
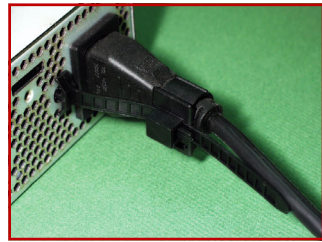
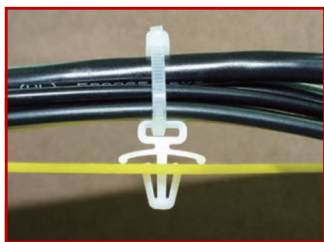
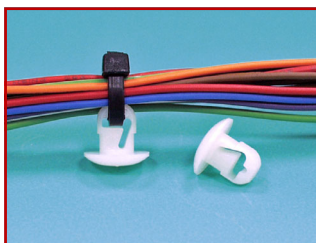
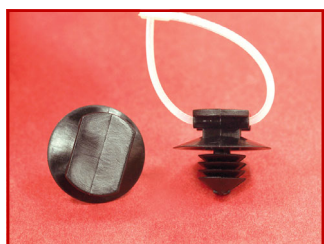
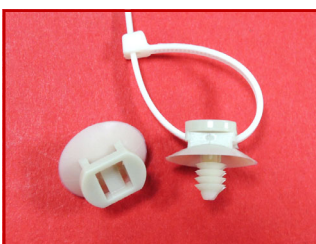
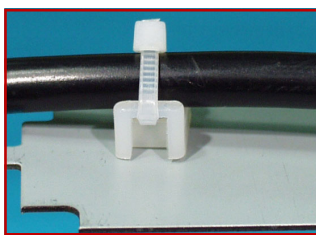

排线固定座

排线固定座 自粘式配线固定座 排线固定夹 压线板 电线固定座 扭线固定座 扭式固定环 扎线固定座 电源线固定座 电源线固定座插头固定扣 天线固定座 T8灯管固定座 风扇束线座 光纤固定座

排线固定座

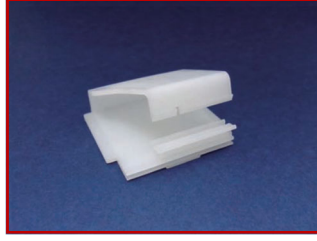
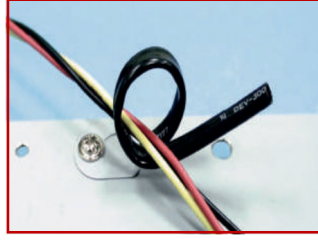
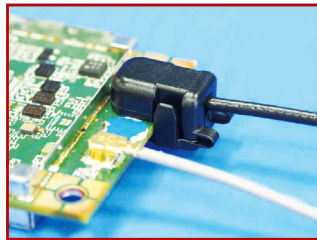
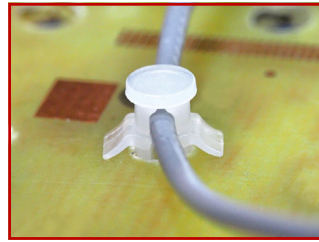
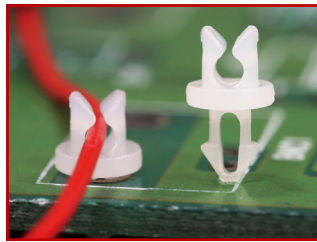
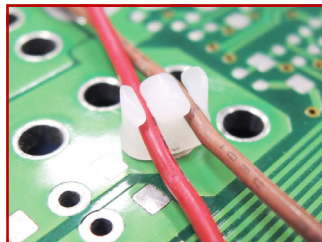
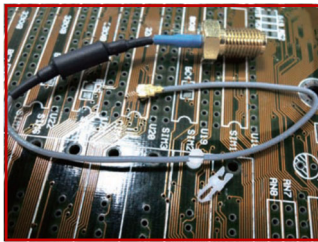
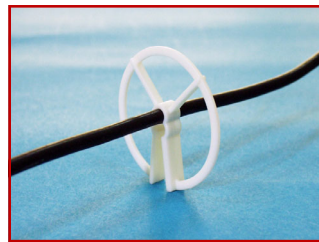
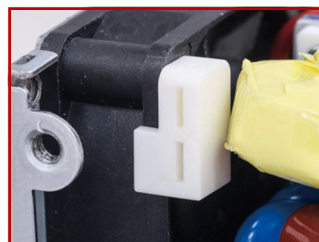
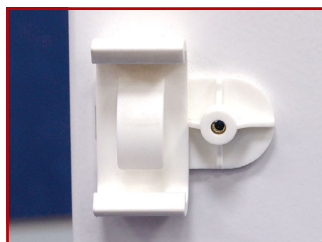
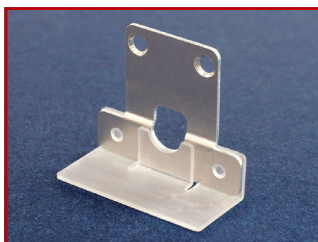

排线固定座 自粘式配线固定座 排线固定夹 压线板 电线固定座 扭线固定座 扭式固定环 扎线固定座 电源线固定座 电源线固定座插头固定扣 天线固定座 T8灯管固定座 风扇束线座 光纤固定座

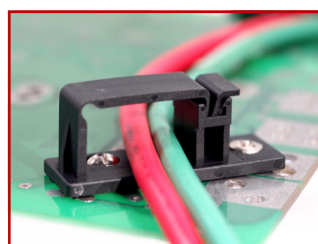
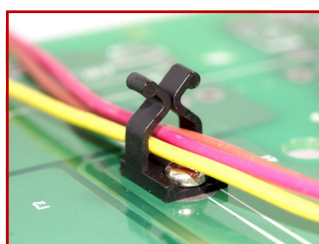
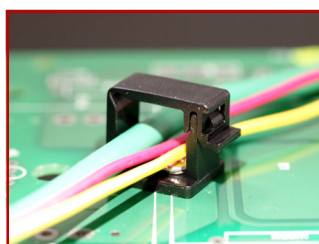

排线固定座

排线固定座 自粘式配线固定座 排线固定夹 压线板 电线固定座 扭线固定座 扭式固定环 扎线固定座 电源线固定座 电源线固定座插头固定扣 天线固定座 T8灯管固定座 风扇束线座 光纤固定座

排线固定座 FLAT CABLE CLAMP 自粘式配线固定座 背胶式 配线固定座



- ◆ MATERIAL : NYLON 66(UL)
- ◆ FLAME CLASS : 94V-2,94V-0
- ◆ COLOR : BLACK / NATURAL
- ◆ UNIT: mm

用途：排线固定座，自粘式配线固定座，背胶式，用于电子、计算机内部排线固定，装配容易，美观不脱落。

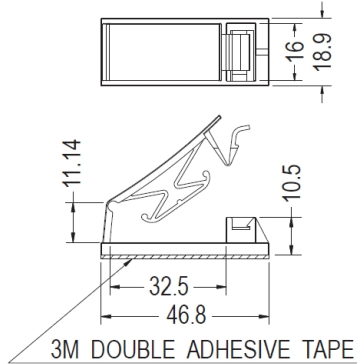

PART NO	PACKAGE
FCC-03	100

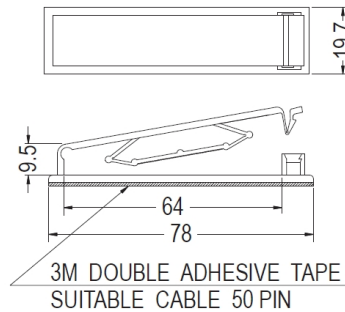
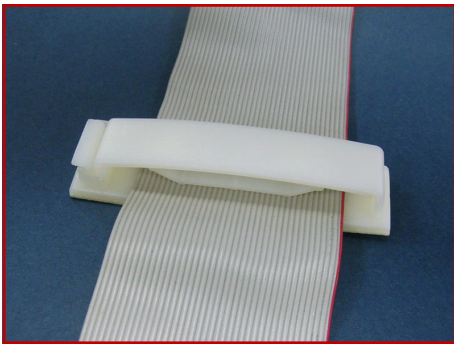

PART NO	PACKAGE
FCC-04	100

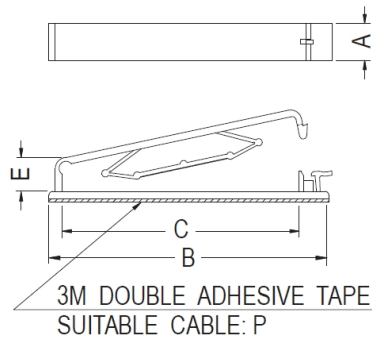
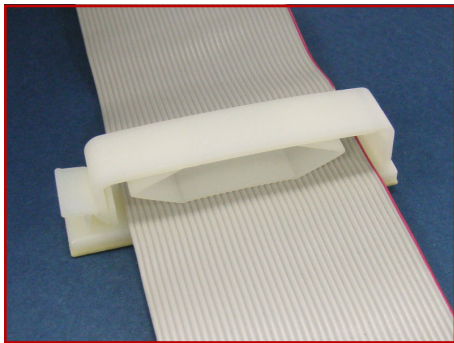

PART NO	A	B	C	E	P	PACKAGE
FCC-05	10.2	65.0	53.8	8.23	40PIN	200
FCC-06	10.0	77.0	64.5	9.20	50PIN	100

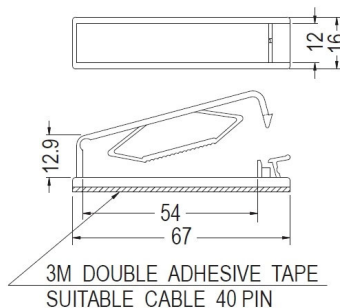

PART NO	PACKAGE
FCC-07	100
FCC-08	100

排线固定座

排线固定座 FLAT CABLE CLAMP 自粘式配线固定座 背胶式 配线固定座

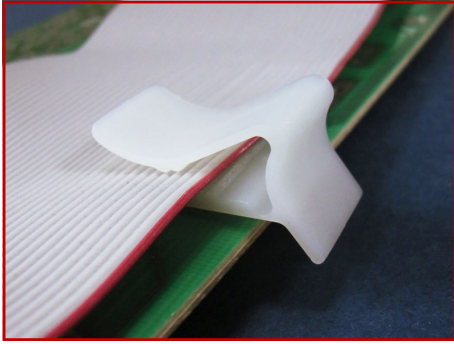

- ◆ MATERIAL : NYLON 66(UL)
- ◆ FLAME CLASS : 94V-2,94V-0
- ◆ COLOR : BLACK / NATURAL
- ◆ UNIT: mm

用途：排线固定座，用于电子、计算机内部排线固定，装配容易，美观不脱落，固定力强。

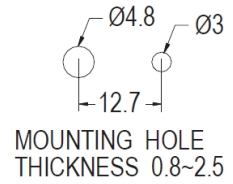
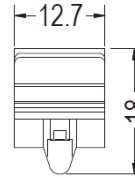
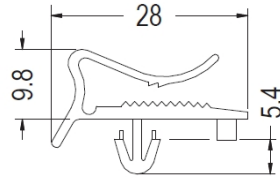

MOUNTING HOLE THICKNESS 0.8-2.5

PART NO	PACKAGE
FCC-09	500

排线固定座

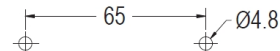
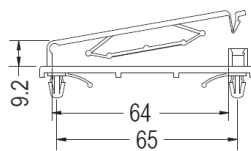
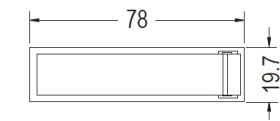
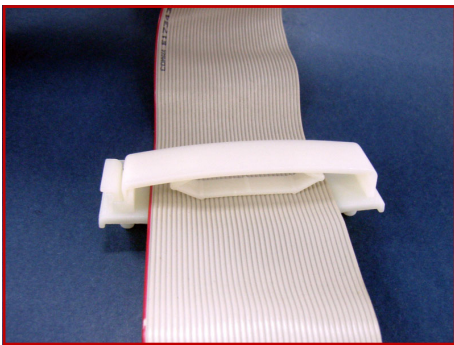

MOUNTING HOLE THICKNESS 0.8-2.2
SUITABLE CABLE 50 PIN

PART NO	PACKAGE
FCC-10	50

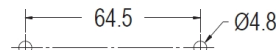
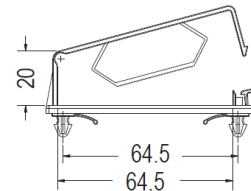
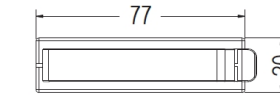

MOUNTING HOLE THICKNESS 2.0
SUITABLE CABLE 50 PIN

PART NO	PACKAGE
FCC-40	50

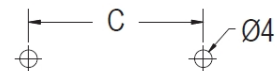
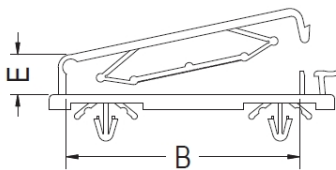
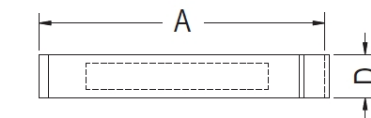
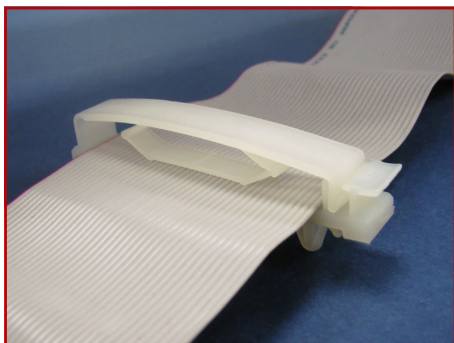

MOUNTING HOLE THICKNESS: T
SUITABLE CABLE: P

PART NO	A	B	C	D	E	T	P	PACKAGE
FCC-11	55.0	39.6	35.0	12.5	9.0	0.8~1.8	35PIN	100
FCC-12	65.0	53.8	40.0	10.2	8.0	0.8~2.2	40PIN	100
FCC-13	77.0	64.3	49.7	10.0	9.2	0.8~2.0	50PIN	100

排线固定座 FLAT CABLE CLAMP 自粘式配线固定座 背胶式 配线固定座



- ◆ MATERIAL : NYLON 66(UL)
- ◆ FLAME CLASS : 94V-2,94V-0
- ◆ COLOR : BLACK / NATURAL
- ◆ UNIT: mm

用途: 排线固定座, 自粘式配线固定座, 背胶式, 用于电子、计算机内部排线固定, 装配容易, 美观不脱落。

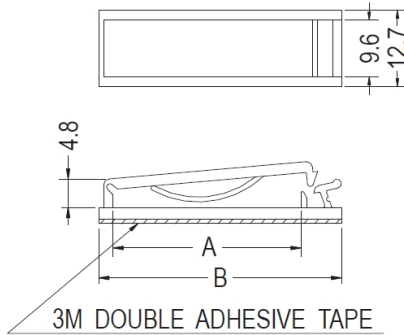

PART NO	A	B	PACKAGE
FCC-14	31.5	40.7	200
FCC-15	52.0	61.2	100

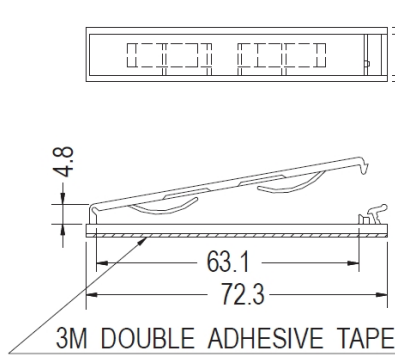
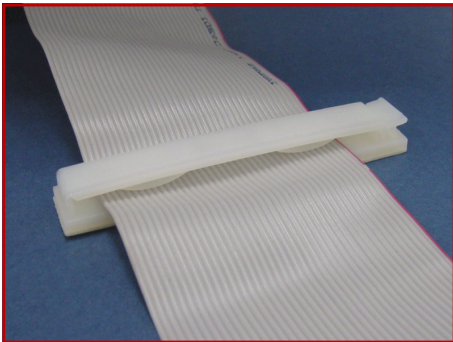

PART NO	PACKAGE
FCC-16	100

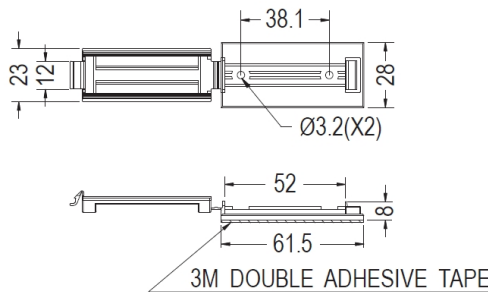

PART NO	PACKAGE
FCC-24	50

- ◆ COLOR : BLACK / NATURAL/GRAY



- ◆ MATERIAL : NYLON 66(UL)
- ◆ FLAME CLASS : 94V-2,94V-0
- ◆ COLOR : BLACK / NATURAL
- ◆ UNIT: mm

用途: 排线固定座, 配线固定座用于电子、计算机内部排线固定, 装配容易, 美观不脱落, 固定力强。

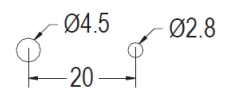
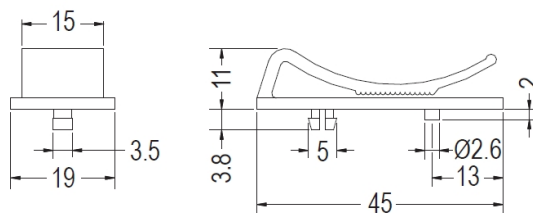

MOUNTING HOLE CHASSIS THICKNESS 1.2

PART NO	PACKAGE
FCC-19	1000

排线固定座 FLAT CABLE CLAMP 自粘式配线固定座 背胶式 配线固定座



- ◆ MATERIAL : NYLON 66(UL)
- ◆ FLAME CLASS : 94V-2,94V-0
- ◆ COLOR : BLACK / NATURAL/GRAY
- ◆ UNIT: mm

用途：排线固定座,自粘式配线固定座,背胶式,用于电子、计算机内部排线固定,装配容易,美观不脱落。

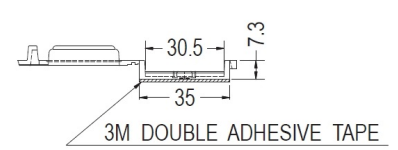
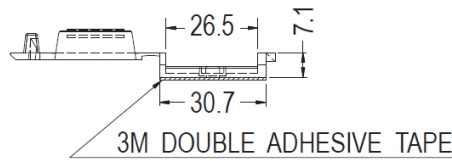
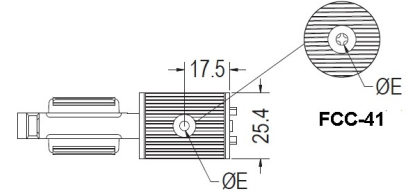
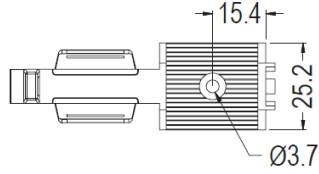

PART NO	PACKAGE
FCC-20	50

PART NO	E	PACKAGE
FCC-21	3.7	100
FCC-41	4.5	100

排线固定座

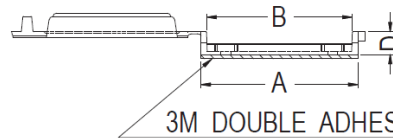
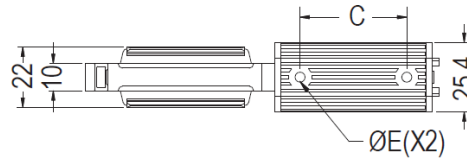

PART NO	A	B	C	D	E	PACKAGE
FCC-22	57.3	53.0	39.0	8.3	3.7	50
FCC-23	82.3	78.93	38.7	12.3	3.8	50

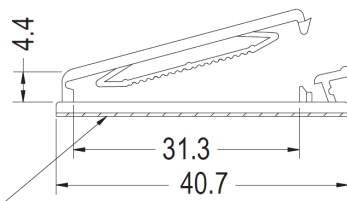
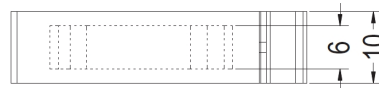

3M DOUBLE ADHESIVE TAPE

- ◆ COLOR : BLACK / NATURAL

PART NO	PACKAGE
FCC-25	200

排线固定座 FLAT CABLE CLAMP 自粘式配线固定座 背胶式 配线固定座



- ◆ MATERIAL : NYLON 66(UL)
- ◆ FLAME CLASS : 94V-2,94V-0
- ◆ COLOR : BLACK / NATURAL
- ◆ UNIT: mm

用途：排线固定座，自粘式配线固定座，背胶式，用于电子、计算机内部排线固定，装配容易，美观不脱落。

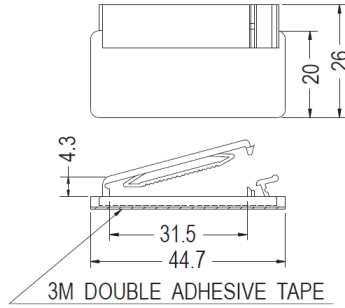

PART NO	PACKAGE
FCC-26	100

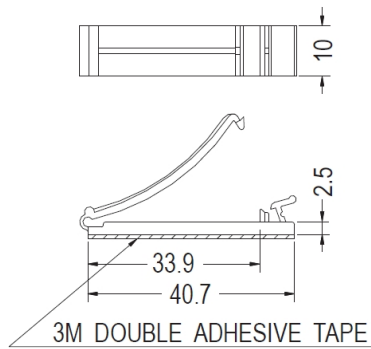
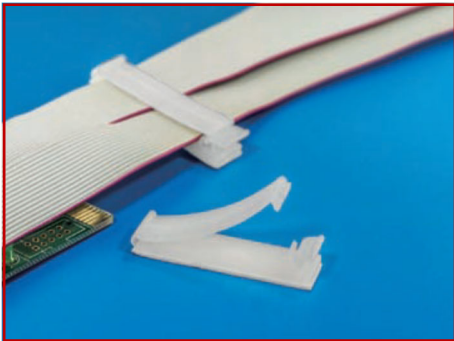

PART NO	PACKAGE
FCC-27	100

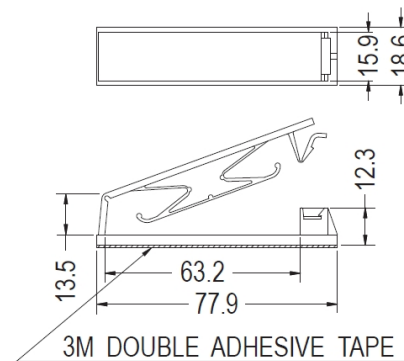
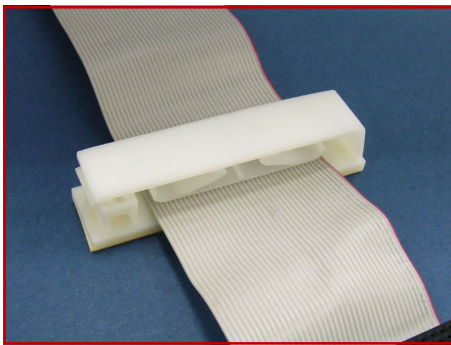

PART NO	PACKAGE
FCC-28	100

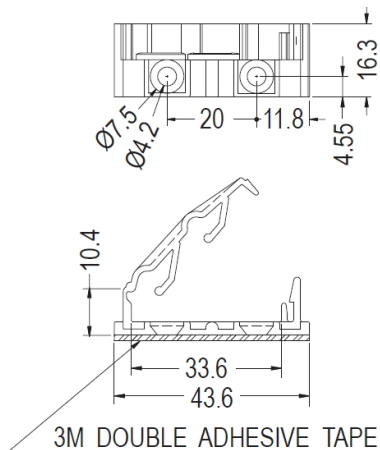

PART NO	PACKAGE
FCC-29	200

排线固定座

排线固定座 FLAT CABLE CLAMP 自粘式配线固定座 背胶式 配线固定座



- ◆ MATERIAL : NYLON 66(UL)
- ◆ FLAME CLASS : 94V-2,94V-0
- ◆ COLOR : BLACK / NATURAL/GRAY
- ◆ UNIT: mm

用途: 排线固定座,自粘式配线固定座,背胶式,用于电子、计算机内部排线固定,装配容易,美观不脱落。

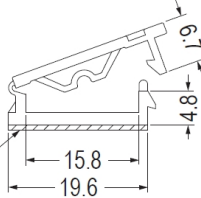
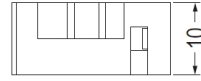

3M DOUBLE ADHESIVE TAPE

PART NO	PACKAGE
FCC-30	500

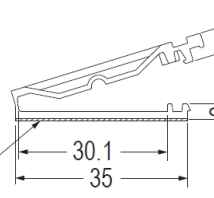

3M DOUBLE ADHESIVE TAPE

PART NO	PACKAGE
FCC-31	200

排线固定座

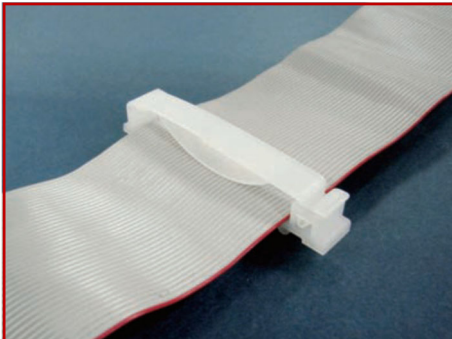

- ◆ MATERIAL : NYLON 66(UL)
- ◆ FLAME CLASS : 94V-2,94V-0
- ◆ COLOR : BLACK / NATURAL/GRAY
- ◆ UNIT: mm

用途: 排线固定座,配线固定座,用于电子、计算机内部排线固定,装配容易,美观不脱落。

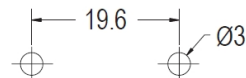

MOUNTING HOLE THICKNESS: T

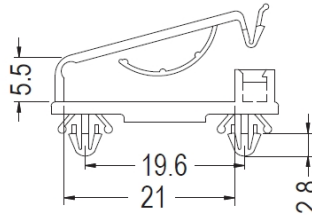

PART NO	T	PACKAGE
FCC-33	0.8~1.2	1000
FCC-42	0.8~1.6	1000

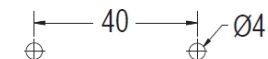
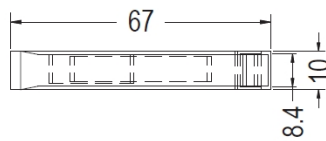
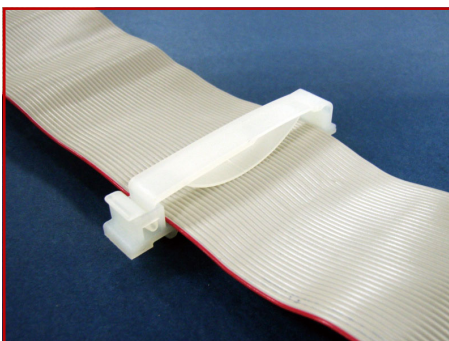

MOUNTING HOLE THICKNESS 0.8~2.0

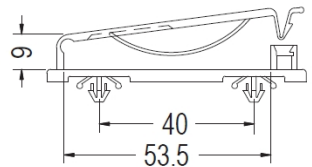

PART NO	PACKAGE
FCC-34	100

排线固定座 FLAT CABLE CLAMP 自粘式配线固定座 背胶式 配线固定座



- ◆ MATERIAL : NYLON 66(UL)
- ◆ FLAME CLASS : 94V-2,94V-0
- ◆ COLOR : BLACK / NATURAL
- ◆ UNIT: mm

用途: 排线固定座, 自粘式配线固定座, 背胶式, 用于电子、计算机内部排线固定, 装配容易, 美观不脱落。

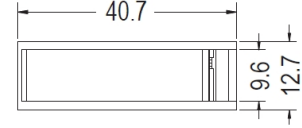
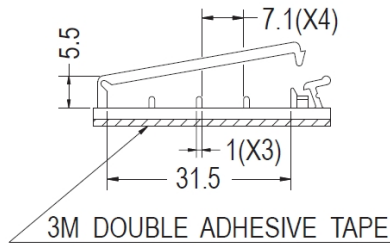

PART NO	PACKAGE
FCC-36	200

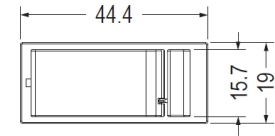
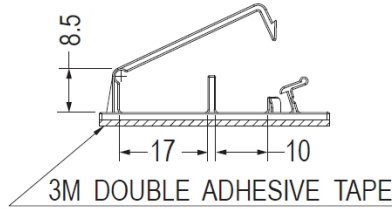
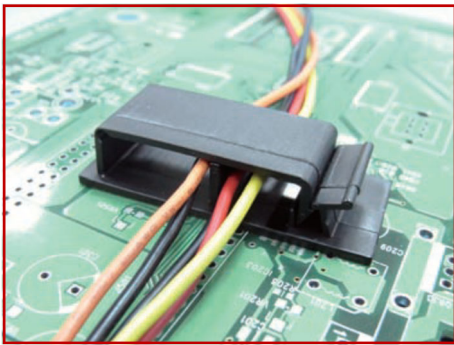

PART NO	PACKAGE
FCC-51	200

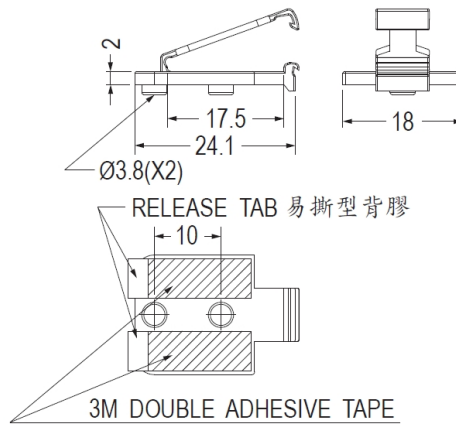
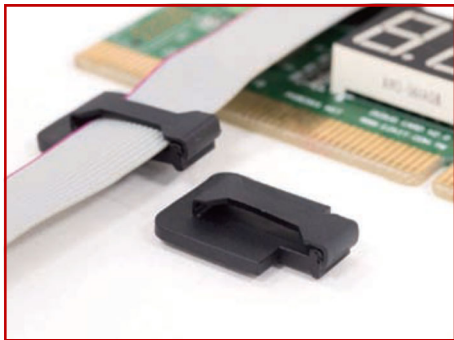

PART NO	PACKAGE
FCC-38	1000

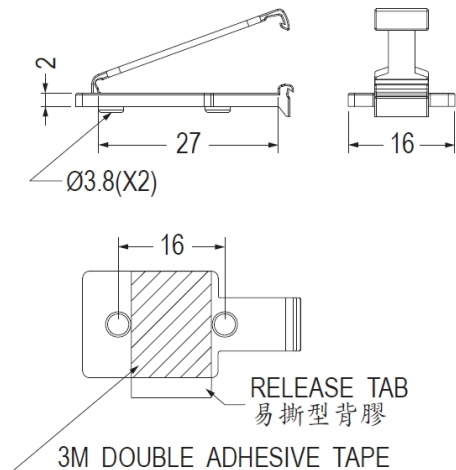
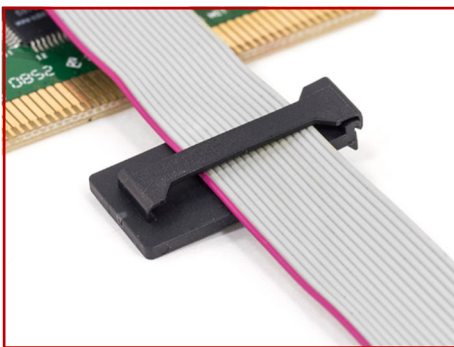

PART NO	PACKAGE
FCC-39	1000

排线固定座

排线固定座 FLAT CABLE CLAMP 自粘式配线固定座 背胶式 配线固定座

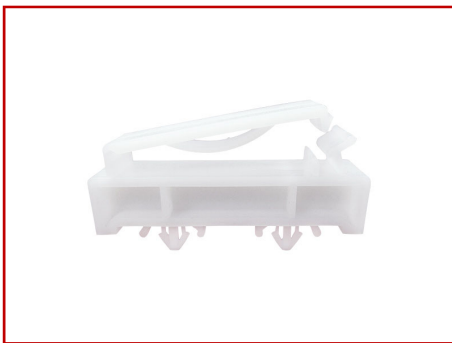

- ◆ MATERIAL : NYLON 66(UL)
- ◆ FLAME CLASS : 94V-2,94V-0
- ◆ COLOR : BLACK / NATURAL
- ◆ UNIT: mm

用途：排线固定座，配线固定座，背胶式，用于电子、计算机内部排线固定，装配容易，美观不脱落。

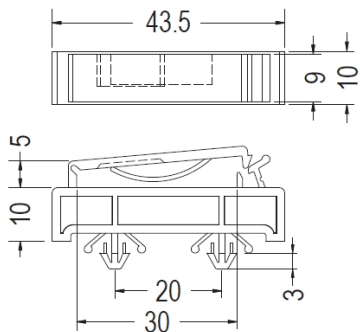

MOUNTING HOLE
THICKNESS 0.8~2.0

PART NO	PACKAGE
FCC-37	100

排线固定夹 FLAT CABLE CLAMP 压线板



- ◆ MATERIAL : NYLON 66(UL)
- ◆ FLAME CLASS : 94V-2,94V-0
- ◆ COLOR : BLACK / NATURAL
- ◆ UNIT: mm

用途: 排线固定夹, 压线板, 用于电子、计算机内部排线固定, 装配容易, 美观不脱落。

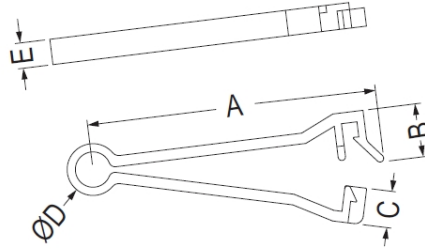

SUITABLE CABLE: P

PART NO	A	B	C	D	E	P	PACKAGE
FCC-17	70.2	12.2	8.7	12.8	6.2	40PIN	100
FCC-18	62.3	13.0	8.9	12.0	6.4	30PIN	100

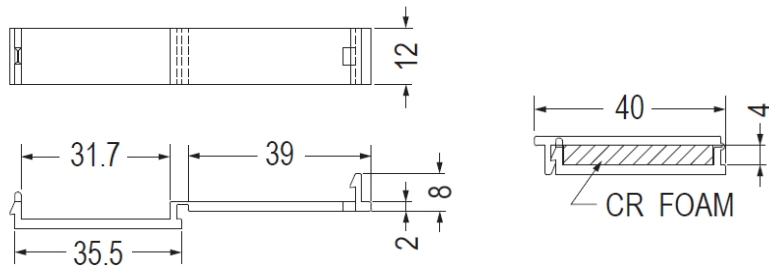
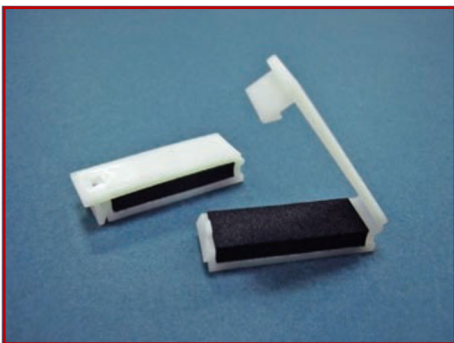

PART NO	PACKAGE
FCC-32	100

排线固定夹

排线固定板 FLAT CABLE CLAMP 自粘式配线固定座 背胶式 配线固定座



- ◆ MATERIAL : NYLON 66(UL)
- ◆ FLAME CLASS : 94V-2,94V-0
- ◆ COLOR : BLACK / NATURAL
- ◆ UNIT: mm

用途：排线固定板，自粘式配线固定座，背胶式，用于电子、计算机内部排线固定，装配容易，美观不脱落。

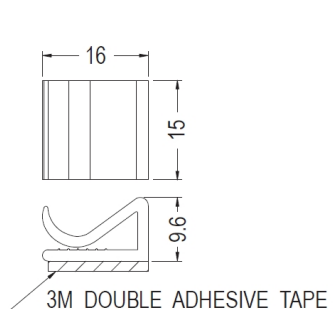

PART NO	PACKAGE
FCC-35	500

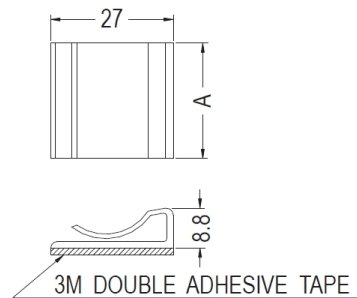

PART NO	A	PACKAGE
FCC-48	15.0	500
FCC-49	20.0	500
FCC-50	25.4	500

排线固定板

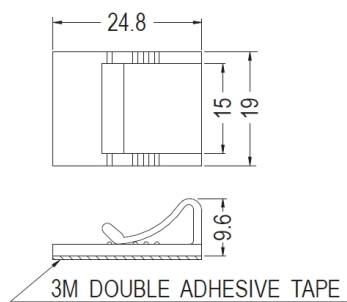
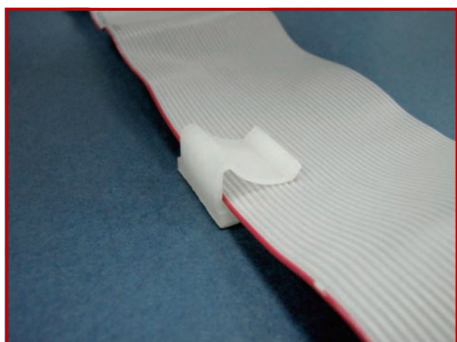

PART NO	PACKAGE
FCC-43	500

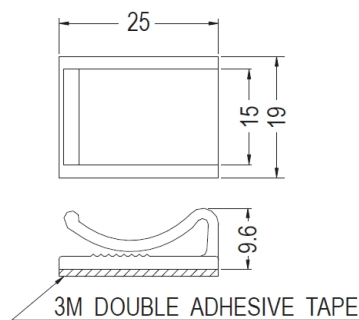

PART NO	PACKAGE
FCC-44	500

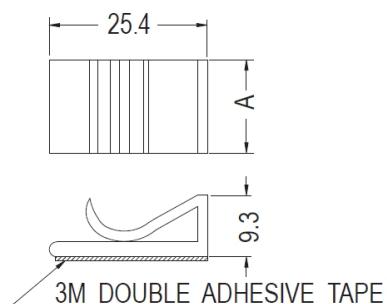

PART NO	A	PACKAGE
FCC-45	15.0	500
FCC-46	20.0	500
FCC-47	25.0	250

电线固定座 FLAT CABLE CLAMP 配线固定座

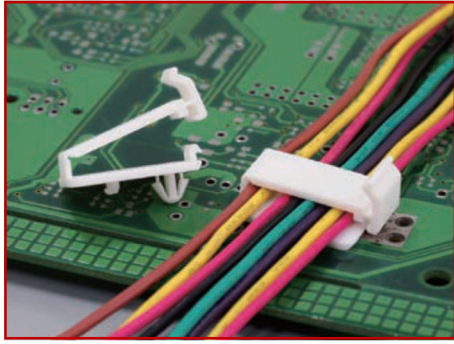

- ◆ MATERIAL : NYLON 66(UL)
- ◆ FLAME CLASS : 94V-2,94V-0
- ◆ COLOR : BLACK / NATURAL
- ◆ UNIT: mm

用途： 电线固定座,配线固定座固定电线于机板上，维修方便，不占空间。

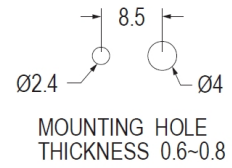
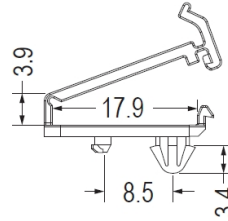
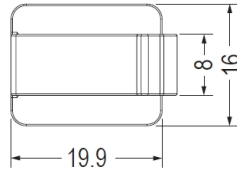

PART NO	PACKAGE
WS-T589	1000

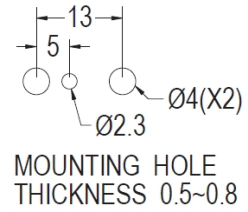
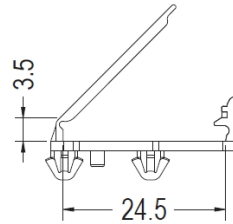
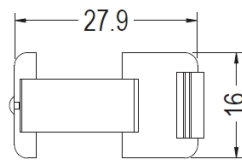
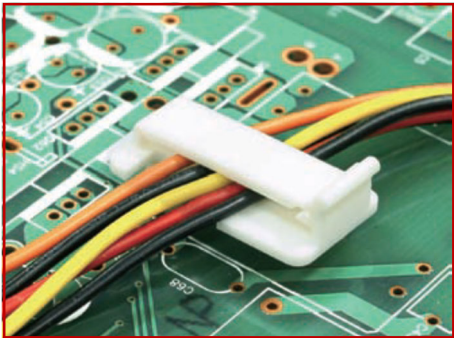

PART NO	PACKAGE
WS-T472	1000

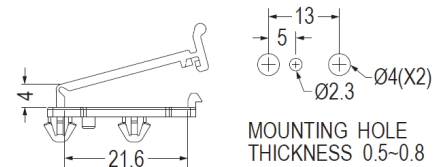
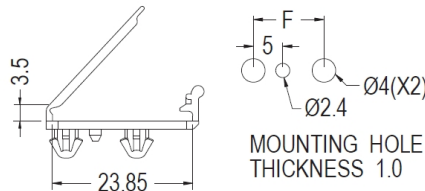
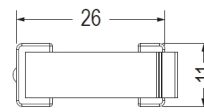
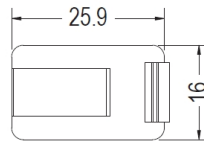
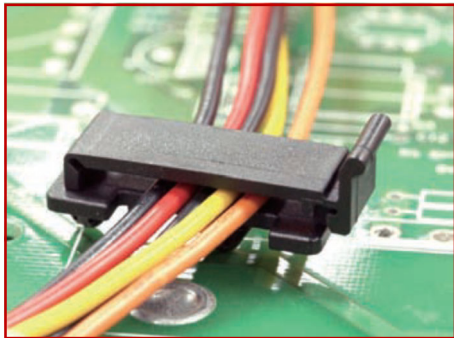

PART NO	F	PACKAGE
WS-T473	12.0	1000
WS-T604	13.0	1000

PART NO	PACKAGE
WS-T474	1000

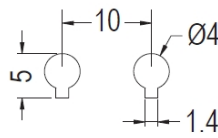
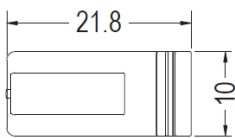

MOUNTING HOLE THICKNESS 1.5

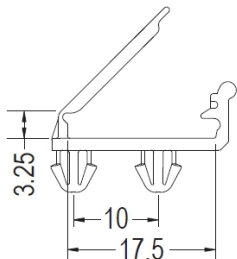

PART NO	PACKAGE
WS-T887	1000

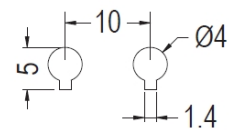
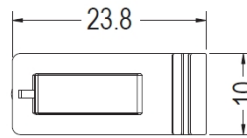

MOUNTING HOLE THICKNESS 1.5

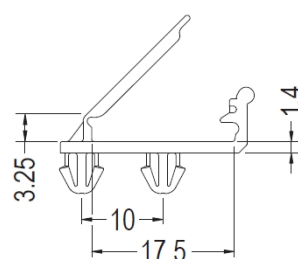

PART NO	PACKAGE
WS-T888	1000

电线固定座

电线固定座 FLAT CABLE CLAMP 配线固定座



- ◆ MATERIAL : NYLON 66(UL)
- ◆ FLAME CLASS : 94V-2,94V-0
- ◆ COLOR : BLACK / NATURAL
- ◆ UNIT: mm

用途： 电线固定座,配线固定座固定电线于PCB线路板或机板上，维修方便，不占空间。

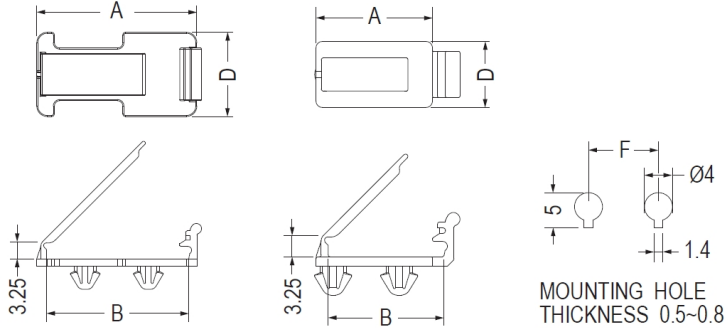

PART NO	A	B	D	F	PACKAGE
WS-T678	17.65	17.5	10.0	10.0	1000
WS-T679	21.15	21.0	10.0	12.0	1000
WS-T680	30.4	27.0	16.0	12.0	1000

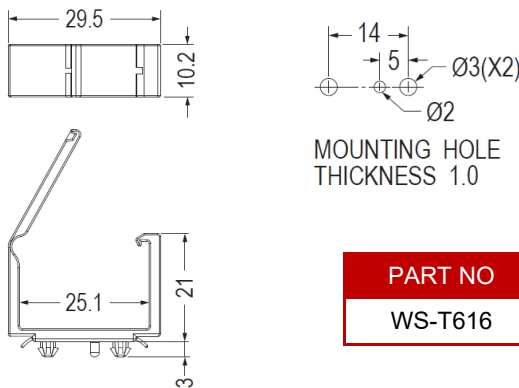

PART NO	PACKAGE
WS-T616	500

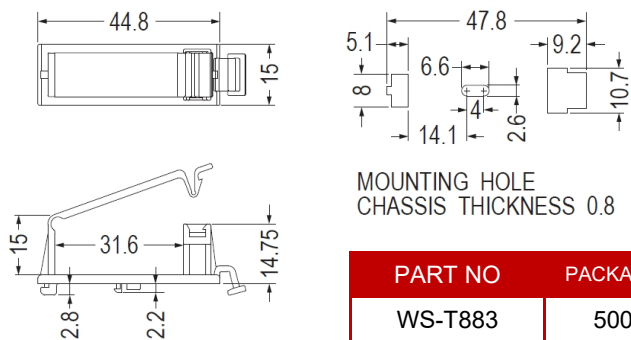

PART NO	PACKAGE
WS-T883	500

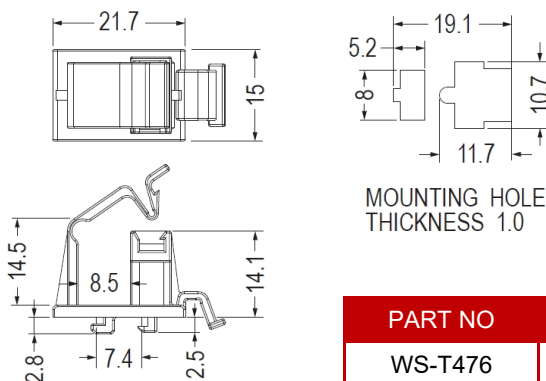
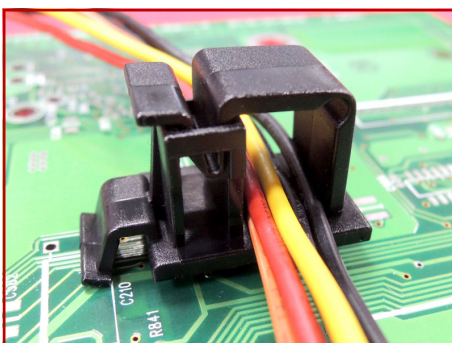

PART NO	PACKAGE
WS-T476	500

电线固定座 FLAT CABLE CLAMP 配线固定座

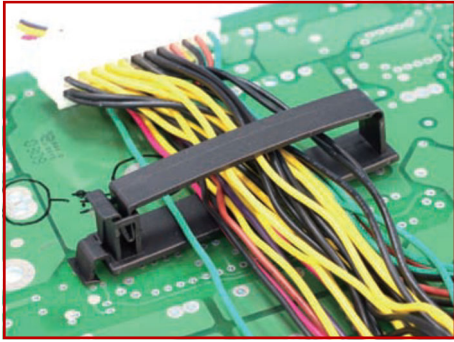

- ◆ MATERIAL : NYLON 66(UL)
- ◆ FLAME CLASS : 94V-2,94V-0
- ◆ COLOR : BLACK / NATURAL
- ◆ UNIT: mm

用途： 电线固定座,配线固定座用于电子、计算机内部电线固定，装配容易，美观不脱落。

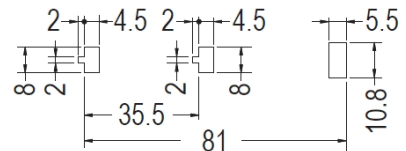
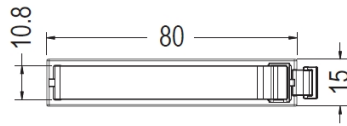

MOUNTING HOLE THICKNESS 1.2

PART NO	PACKAGE
WS-T588	500

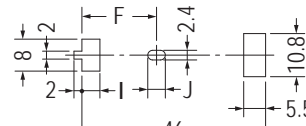
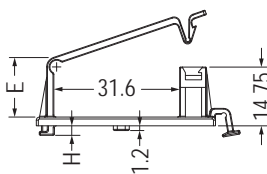
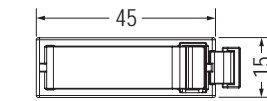
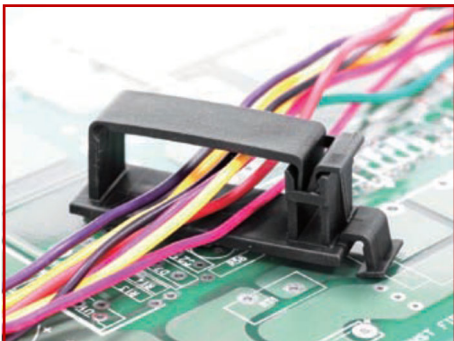

MOUNTING HOLE THICKNESS: T

PART NO	E	F	H	I	J	T	PACKAGE
WS-T085	35.28	25.25	11.0	15.2	13.17	26.0	500
WS-T901	20.7	10.3	7.0	10.2	9.51	9.6	200

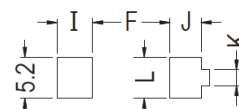
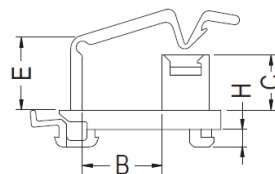
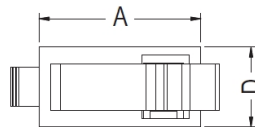
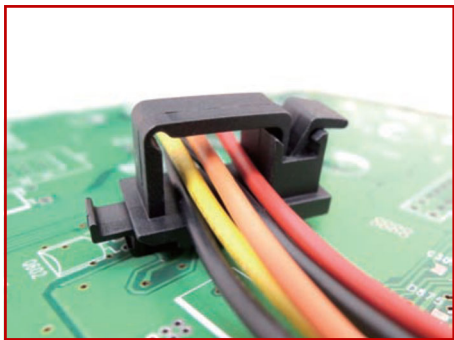

MOUNTING HOLE THICKNESS 0.8

PART NO	A	B	C	D	E	F	G	H	J	K	L	PACKAGE
WS-T084	35.28	25.25	11.0	15.2	13.17	4.0	3.0	2.0	2.1	5.5	26.0	500
WS-T162	20.7	10.3	7.0	10.2	9.51	4.5	4.0	2.0	2.2	5.2	9.6	500

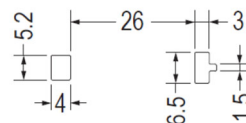
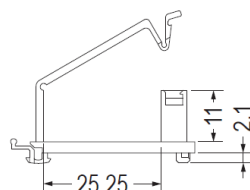
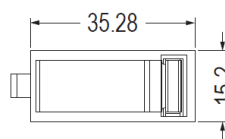
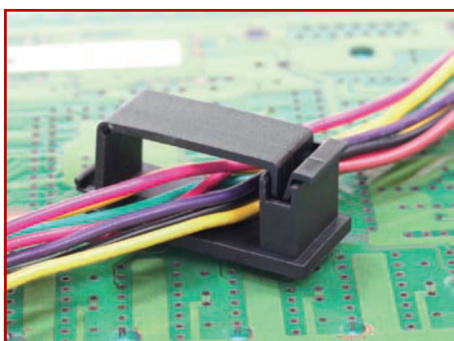

MOUNTING HOLE THICKNESS 0.8

PART NO	PACKAGE
WS-T617	1000

电线固定座

电线固定座 FLAT CABLE CLAMP 配线固定座



- ◆ MATERIAL : NYLON 66(UL)
- ◆ FLAME CLASS : 94V-2,94V-0
- ◆ COLOR : BLACK / NATURAL
- ◆ UNIT: mm

用途：电线固定座,配线固定座用于电子、计算机内部电线固定，装配容易，美观不脱落。

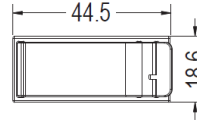
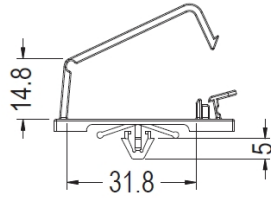

CHASSIS Ø6.5
THICKNESS 0.8~1.6

PART NO	PACKAGE
WS-T369	200

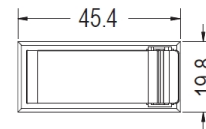
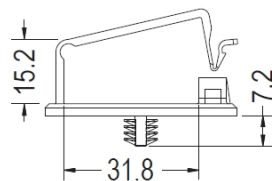

MOUNTING HOLE Ø6.5~Ø7.0
THICKNESS 0.8~3.0

PART NO	PACKAGE
WS-T495	500

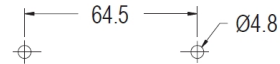
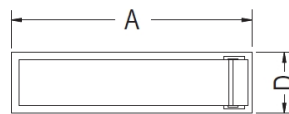
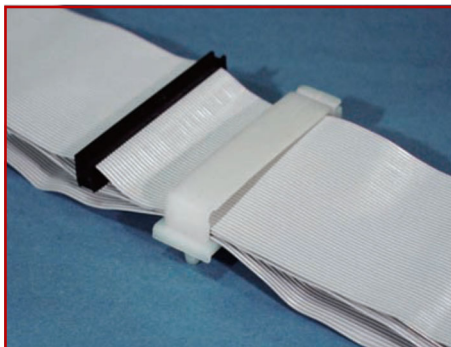

MOUNTING HOLE
THICKNESS 0.8~2.2

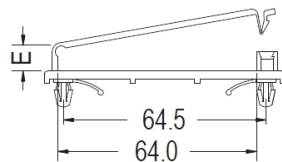

PART NO	A	D	E	PACKAGE
WS-T144	77.4	19.6	9.9	100
WS-T145	77.0	20.0	15.0	100

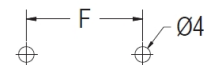
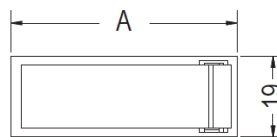

MOUNTING HOLE
THICKNESS 0.8~2.2

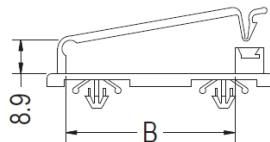

PART NO	A	B	F	PACKAGE
WS-T146	53.8	40.0	30.0	100
WS-T147	45.8	32.0	25.0	100

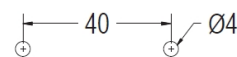
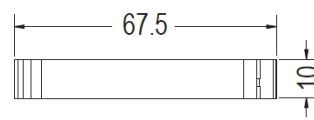

MOUNTING HOLE
THICKNESS: T

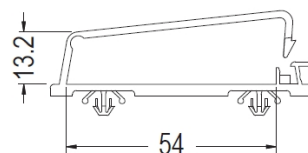

PART NO	A	PACKAGE
WS-T148	2.0	100
WS-T149	0.8~1.0	100
WS-T150	0.8~2.0	100

电线固定座 FLAT CABLE CLAMP 配线固定座



- ◆ MATERIAL : NYLON 66(UL)
- ◆ FLAME CLASS : 94V-2,94V-0
- ◆ COLOR : BLACK / NATURAL
- ◆ UNIT: mm

用途： 电线固定座,配线固定座用于电子、计算机内部电线固定，装配容易，美观不脱落。

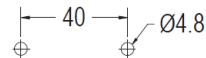
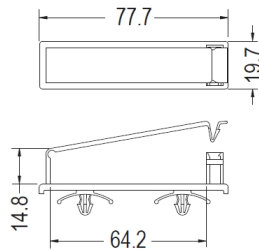

MOUNTING HOLE THICKNESS 0.8~3.2

PART NO	PACKAGE
WS-T151	100

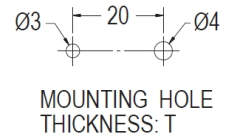
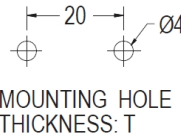
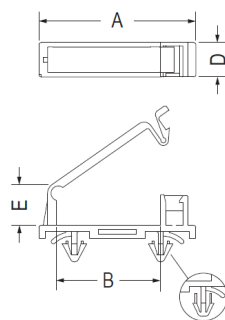

MOUNTING HOLE THICKNESS: T

MOUNTING HOLE THICKNESS: T

WS-T194

PART NO	A	B	D	E	T	PACKAGE
WS-T152	36.0	24.2	8.0	9.9	0.8~1.2	100
WS-T153	36.1	24.2	8.0	9.9	0.8~2.0	100
WS-T155	40.0	28.3	7.9	11.4	0.8~1.2	100
WS-T194	36.0	24.2	8.0	9.5	0.8~1.2	100
WS-T922	40.0	28.3	7.9	11.4	1.2~2.5	100

WS-T153
WS-T922

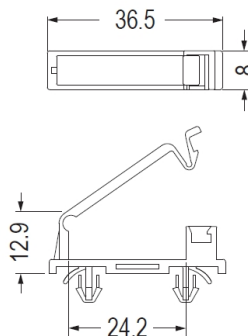
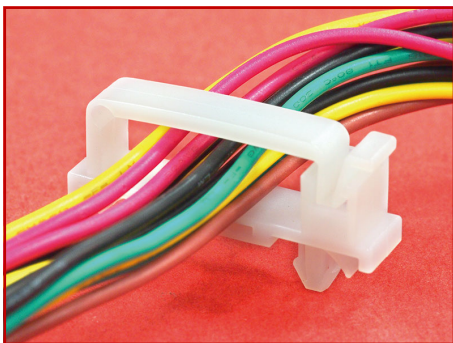

MOUNTING HOLE THICKNESS: T

PART NO	T	PACKAGE
WS-T609	1.2~2.5	500
WS-T610	1.2~3.25	100

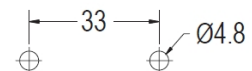
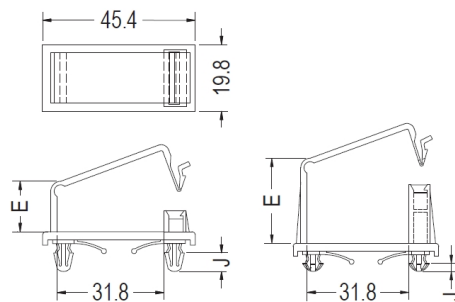

MOUNTING HOLE THICKNESS 0.8~2.2

WS-T196

PART NO	E	J	PACKAGE
WS-T154	14.9	5.5	100
WS-T196	26.5	2.4	100
WS-T370	14.9	2.4	1000

电线固定座

电线固定座 FLAT CABLE CLAMP 配线固定座

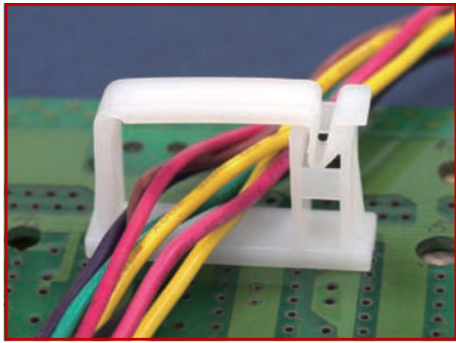

- ◆ MATERIAL : NYLON 66(UL)
- ◆ FLAME CLASS : 94V-2,94V-0
- ◆ COLOR : BLACK / NATURAL
- ◆ UNIT: mm

用途: 电线固定座,配线固定座用于电子、计算机内部电线固定, 装配容易, 美观不脱落。

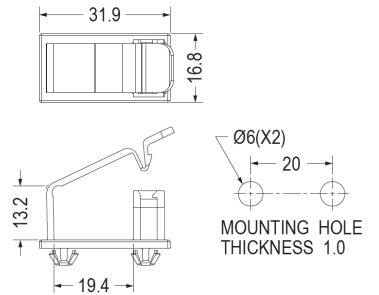
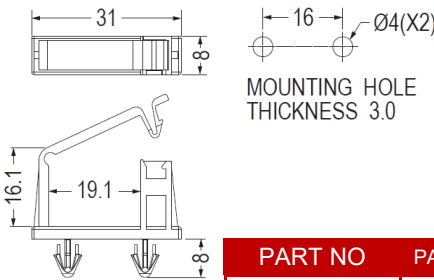

PART NO	PACKAGE
WS-T648	100

PART NO	PACKAGE
WS-T902	200

电线固定座

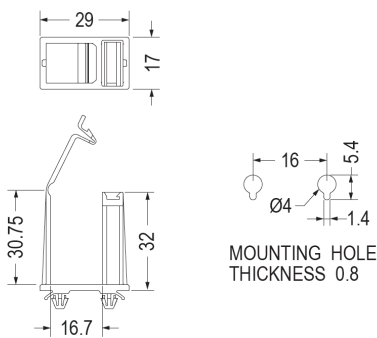

PART NO	PACKAGE
WS-T903	100

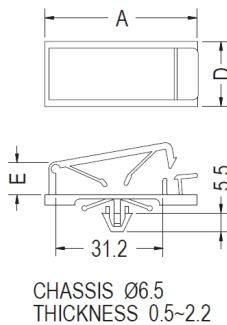

PART NO	A	D	E	PACKAGE
WS-T140	44.3	18.8	9.4	200
WS-T471	44.5	19.0	13.5	200



- ◆ MATERIAL : NYLON 66(UL)
- ◆ FLAME CLASS : 94V-2,94V-0
- ◆ COLOR : BLACK / NATURAL
- ◆ UNIT: mm

用途: 电线固定座,配线固定座固定电线于机壳上, 方便坚固。

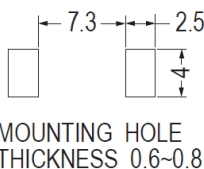
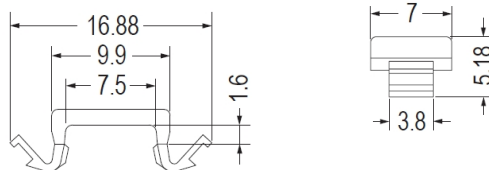

PART NO	PACKAGE
WS-T040	500

电线固定座 FLAT CABLE CLAMP 配线固定座

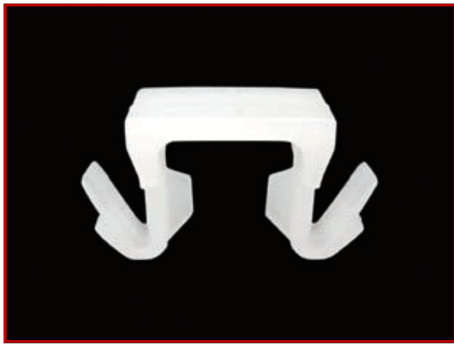

- ◆ MATERIAL : NYLON 66(UL)
- ◆ FLAME CLASS : 94V-2,94V-0
- ◆ COLOR : BLACK / NATURAL
- ◆ UNIT: mm

用途: 电线固定座,配线固定座用于固定电线于机壳上,方便坚固。

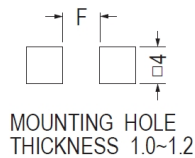
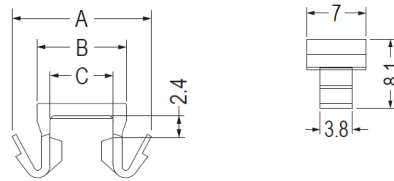

PART NO	A	B	C	F	PACKAGE
WS-T039	15.2	9.8	6.8	4.0	1000
WS-T371	18.1	12.9	10.0	7.1	1000

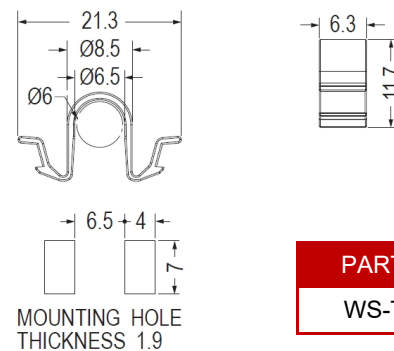

PART NO	PACKAGE
WS-T533	1000

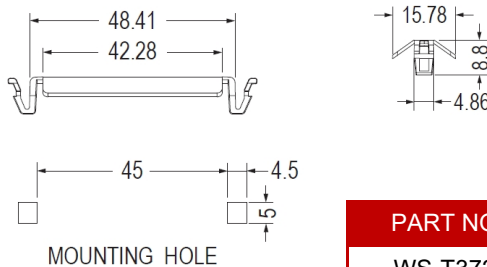

PART NO	PACKAGE
WS-T372	500



- ◆ MATERIAL : NYLON 66(UL)
- ◆ FLAME CLASS : 94V-2,94V-0
- ◆ COLOR : BLACK / NATURAL
- ◆ UNIT: mm

用途: 电线固定座,配线固定座用于电子、计算机LCD-TV内部电线固定,装配容易,美观不脱落。

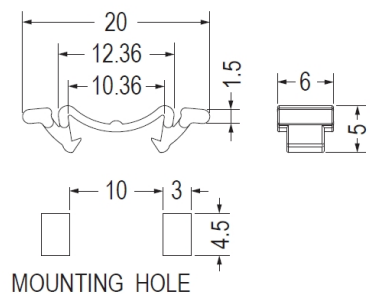
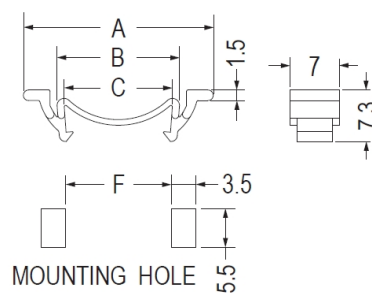

PART NO	A	B	C	F	PACKAGE
WS-T035	27.0	17.4	15.35	15.0	1000
WS-T036	42.0	32.18	30.18	30.0	1000

PART NO	PACKAGE
WS-T195	1000

电线固定座

电线固定座 FLAT CABLE CLAMP 配线固定座

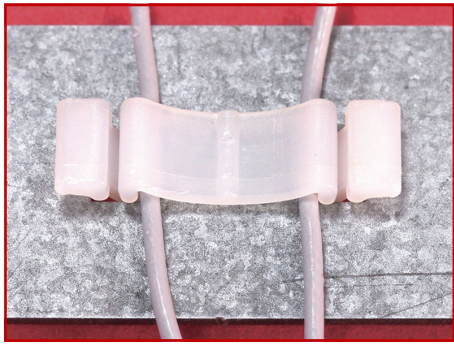

- ◆ MATERIAL : NYLON 66(UL)
- ◆ FLAME CLASS : 94V-2,94V-0
- ◆ COLOR : BLACK / NATURAL
- ◆ UNIT: mm

用途： 电线固定座,配线固定座用于电子、计算机LCD-TV内部电线固定，装配容易，美观不脱落。

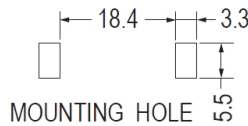
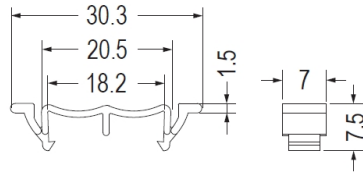

PART NO	PACKAGE
WS-T037	1000

电线固定座

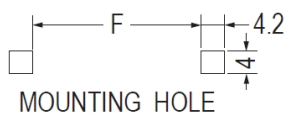
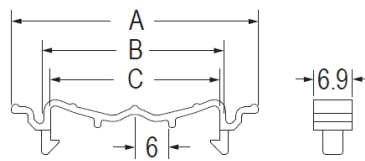

- ◆ MATERIAL : NYLON 66(UL)
- ◆ COLOR : BLACK
- ◆ UNIT: mm

PART NO	A	B	C	F	PACKAGE
WS-T885	43.8	32.2	30.0	30.0	1000
WS-T886	53.8	42.2	40.0	40.0	1000



- ◆ MATERIAL : NYLON 66(UL)
- ◆ FLAME CLASS : 94V-2,94V-0
- ◆ COLOR : BLACK / NATURAL
- ◆ UNIT: mm

用途： 电线固定座,配线固定座可将电线固定于机壳上，电线不易磨损，配线整齐美观。

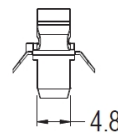
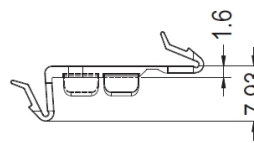
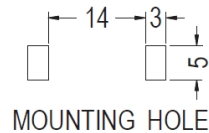
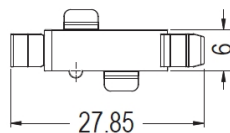

PART NO	PACKAGE
WS-T038	1000

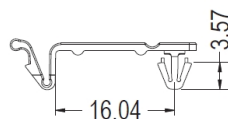
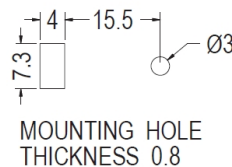

PART NO	PACKAGE
WS-T237	1000

电线固定座 CABLE CLAMP 配线固定座

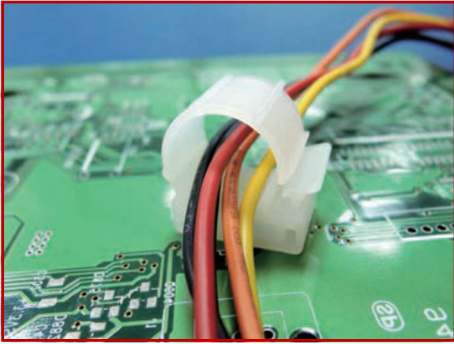

- ◆ MATERIAL : NYLON 66(UL)
- ◆ FLAME CLASS : 94V-2,94V-0
- ◆ COLOR : BLACK / NATURAL
- ◆ UNIT: mm

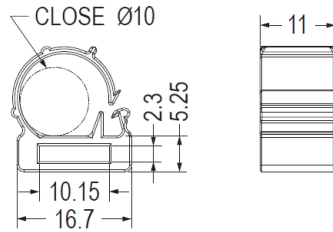

用途： 电线固定座,配线固定座用于固定电线于机板上， 维修方便， 不占空间。

PART NO	PACKAGE
WS-T082	500

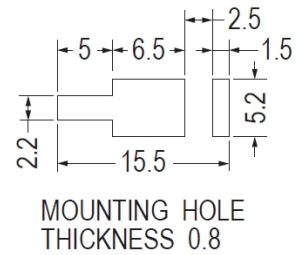
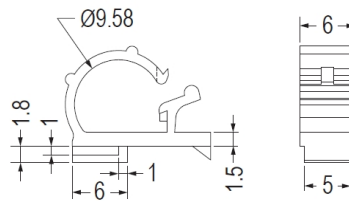

PART NO	PACKAGE
WS-T198	1000



- ◆ MATERIAL : NYLON 66(UL)
- ◆ FLAME CLASS : 94V-2,94V-0
- ◆ COLOR : BLACK / NATURAL
- ◆ UNIT: mm

用途： 电线固定座,配线固定座用于固定电线于PC板或机板上， 维修方便， 不占空间。

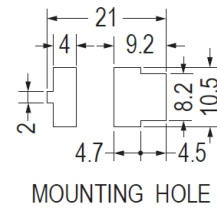
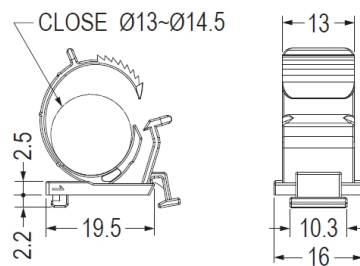

PART NO	PACKAGE
WS-T380	500

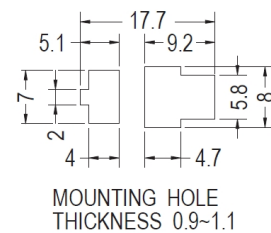
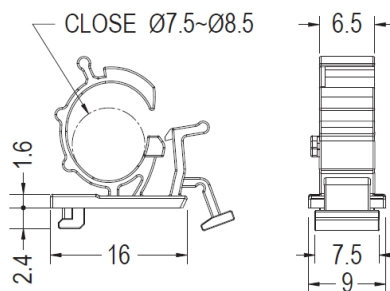

PART NO	PACKAGE
WS-T550	500

电线固定座 CABLE CLAMP 配线固定座

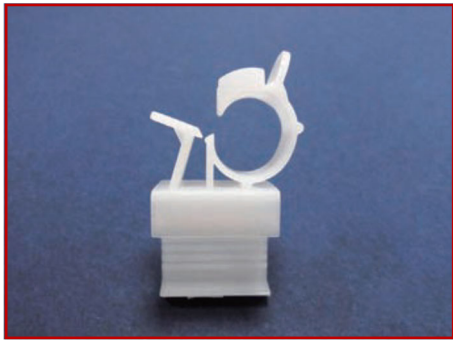

- ◆ MATERIAL : NYLON 66(UL)
- ◆ FLAME CLASS : 94V-2,94V-0
- ◆ COLOR : BLACK / NATURAL
- ◆ UNIT: mm

用途： 电线固定座,配线固定座用于机器上之电线固定。

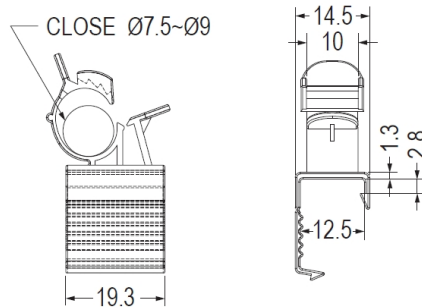

PART NO	PACKAGE
WS-T025	500

电线固定座



- ◆ MATERIAL : NYLON 66(UL)
- ◆ FLAME CLASS : 94V-2,94V-0
- ◆ COLOR : BLACK / NATURAL
- ◆ UNIT: mm

用途： 电线固定座,配线固定座用于C.R.T.消磁线圈之固定。

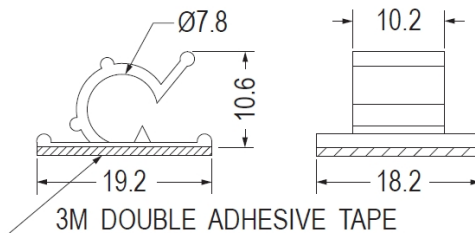

PART NO	PACKAGE
WS-T264	500

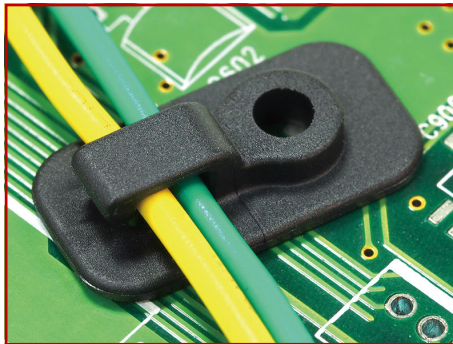

- ◆ MATERIAL : NYLON 66(UL)
- ◆ FLAME CLASS : 94V-2,94V-0
- ◆ COLOR : BLACK / NATURAL
- ◆ UNIT: mm

用途： 电线固定座,配线固定座固定电线于机壳上，维修方便，不占空间。

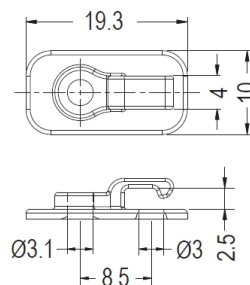

PART NO	PACKAGE
WS-T573	1000

电线固定座 MOUNT 配线固定座



- ◆ MATERIAL : NYLON 66(UL)
- ◆ FLAME CLASS : 94V-2,94V-0
- ◆ COLOR : BLACK / NATURAL
- ◆ UNIT: mm

用途: 电线固定座,配线固定座用于固定电线于机板上, 维修方便, 不占空间。

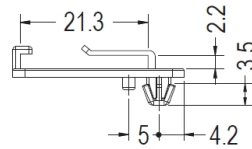
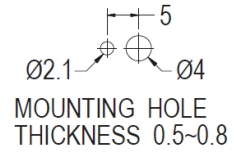
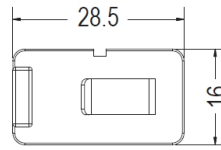

PART NO	PACKAGE
WS-T621	1000
WS-T691	1000

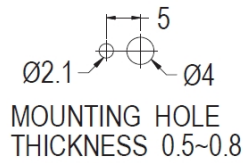
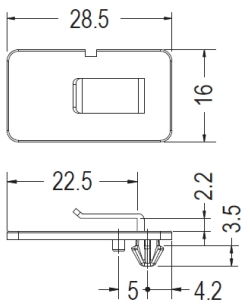

PART NO	PACKAGE
WS-T622	1000

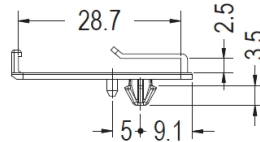
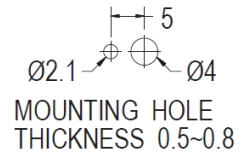
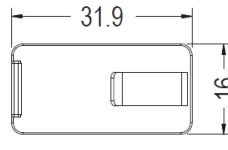

PART NO	PACKAGE
WS-T690	1000

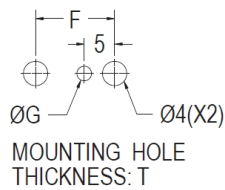
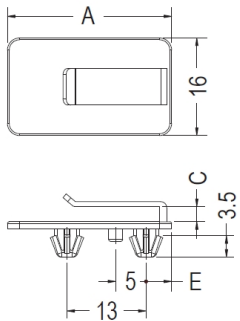
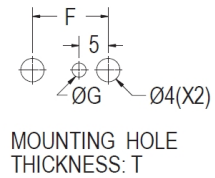
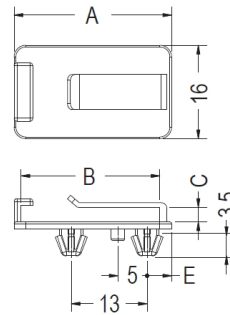

PART NO	A	B	C	E	F	G	T	PACKAGE
WS-T505	27.0	23.8	2.5	4.2	13.0	2.4	0.6~0.8	1000
WS-T508	31.9	28.7	2.5	9.1	13.0	2.1	0.5~0.8	1000
WS-T509	46.2	43.0	2.5	23.4	13.0	2.1	0.5~0.8	500
WS-T510	31.9	28.7	1.4	9.1	13.0	2.1	0.5~0.8	1000
WS-T511	22.5	19.8	1.5	4.2	12.0	2.1	0.5	1000
WS-T512	28.5	25.25	2.55	4.2	13.0	2.4	0.5	1000
WS-T515	31.9	28.7	1.7	9.1	13.0	2.1	0.5~0.8	1000
WS-T608	27.0	23.8	2.5	4.2	13.0	2.2	0.6~0.8	1000

PART NO	A	C	E	F	G	T	PACKAGE
WS-T506	27.0	2.5	4.2	13.0	2.4	0.6~0.8	1000
WS-T507	27.0	2.5	4.2	13.0	2.4	0.6~0.8	1000

电线固定座 FLAT CABLE CLAMP 配线固定座



- ◆ MATERIAL : NYLON 66(UL)
- ◆ FLAME CLASS : 94V-2,94V-0
- ◆ COLOR : BLACK / NATURAL
- ◆ UNIT: mm

用途： 电线固定座,配线固定座固定电线于机板上，维修方便，不占空间。

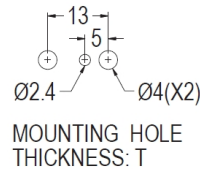
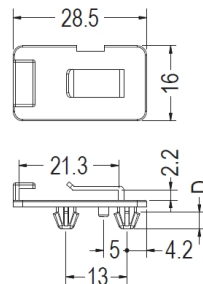
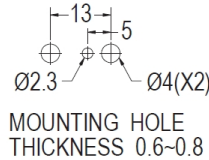
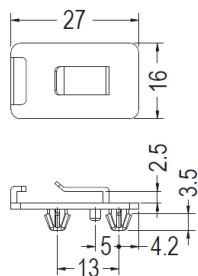

PART NO	PACKAGE
WS-T513	1000

PART NO	D	T	PACKAGE
WS-T514	3.5	0.6~0.8	1000
WS-T607	2.7	1.0	1000
WS-T623	3.5	0.6~0.8	1000

电线固定座

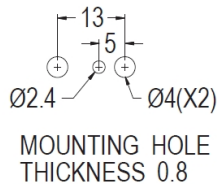
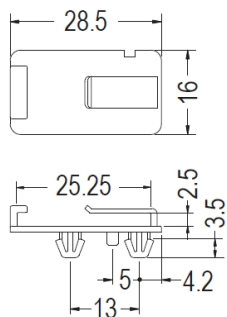

PART NO	PACKAGE
WS-T566	1000

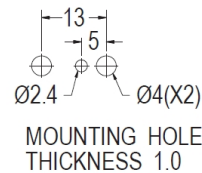
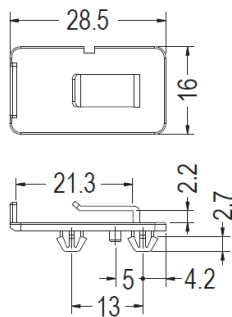

PART NO	PACKAGE
WS-T625	1000

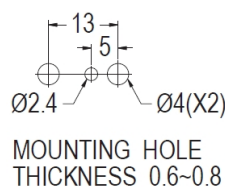
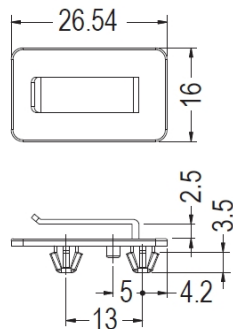

PART NO	PACKAGE
WS-T624	1000

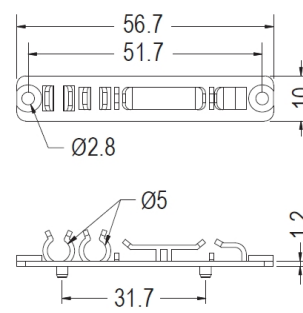
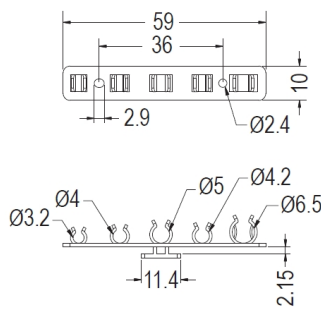

PART NO	PACKAGE
WS-T191	100

PART NO	PACKAGE
WS-T192	100

电线固定座 WIRE MOUNT 配线固定座



- ◆ MATERIAL : NYLON 66(UL)
- ◆ FLAME CLASS : 94V-2,94V-0
- ◆ COLOR : BLACK / NATURAL
- ◆ UNIT: mm

用途: 电线固定座,配线固定座可快速拆卸, 固定电线维修方便, 不占空间。

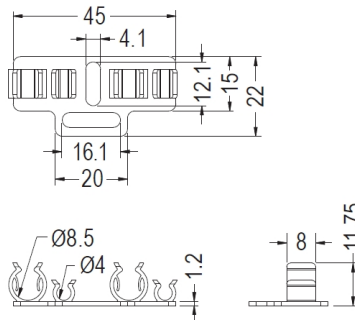

PART NO	PACKAGE
WS-T125	500

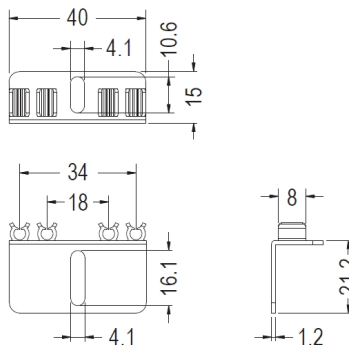
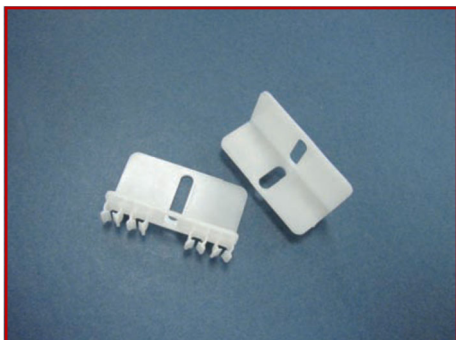

PART NO	PACKAGE
WS-T126	1000

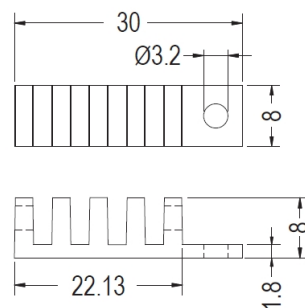

PART NO	PACKAGE
WS-T017	1000

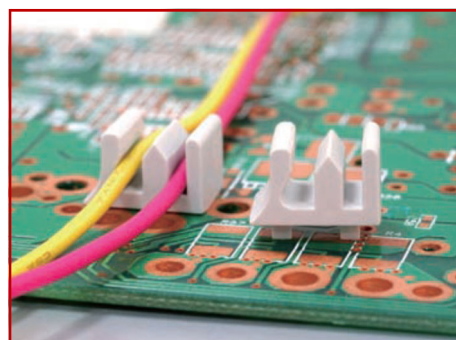

- ◆ MATERIAL : PC+ABS(UL)
- ◆ FLAME CLASS : 94V-2,94V-0
- ◆ COLOR : GRAY
- ◆ UNIT: mm

用途: 电线固定座,配线固定座可快速固定电线在机壳上。

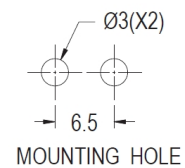
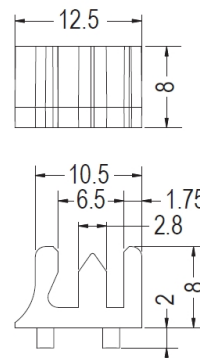

PART NO	PACKAGE
WS-T049	1000

电线固定座

电线固定座 WIRE MOUNT 配线固定座

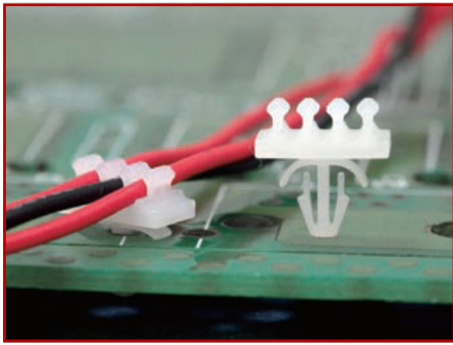

- ◆ MATERIAL : NYLON 66(UL)
- ◆ FLAME CLASS : 94V-2,94V-0
- ◆ COLOR : BLACK / NATURAL
- ◆ UNIT: mm

用途： 电线固定座,配线固定座将电线固定于机壳上, 电线不易磨损, 配线整齐美观。

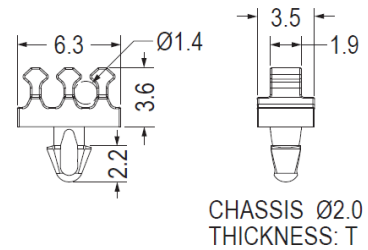
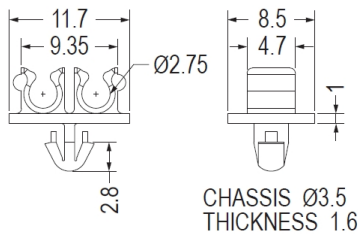

PART NO	PACKAGE
WS-T204	1000

PART NO	T	PACKAGE
WS-T567	1.0	1000
WS-T920	1.6	1000

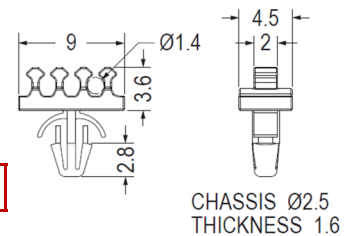
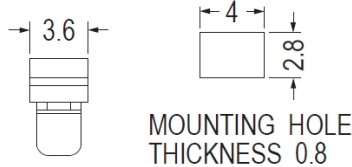
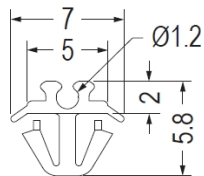

PART NO	PACKAGE
WS-T568	1000

PART NO	PACKAGE
WS-T693	1000
WS-T921	1000

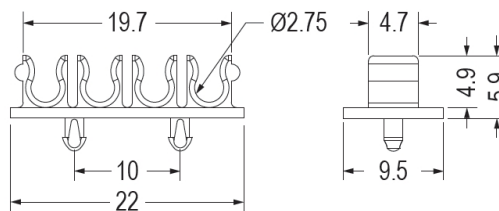
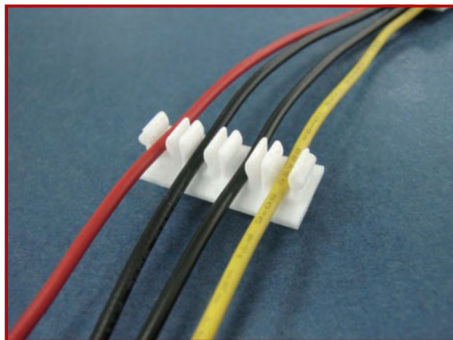

PART NO	PACKAGE
WS-T203	1000

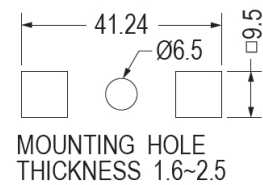
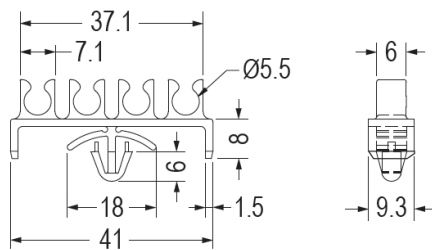

PART NO	PACKAGE
WS-T205	500

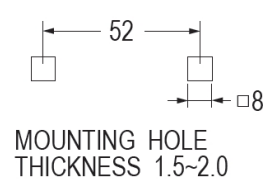
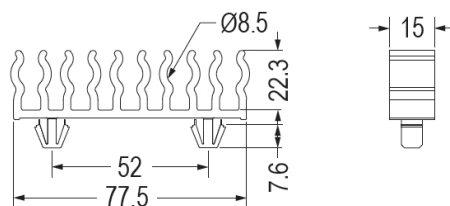

PART NO	PACKAGE
WS-T420	200

电线固定座 WIRE MOUNT 配线固定座

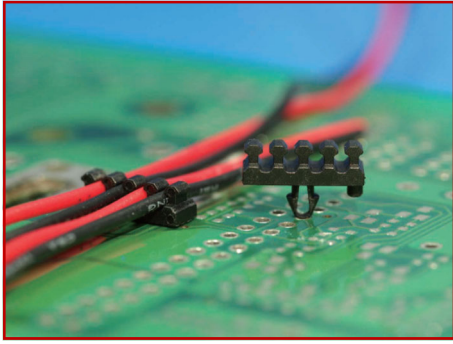

- ◆ MATERIAL : NYLON 66(UL)
- ◆ FLAME CLASS : 94V-2,94V-0
- ◆ COLOR : BLACK / NATURAL
- ◆ UNIT: mm

用途： 电线固定座,配线固定座将电线固定于机壳上, 电线不易磨损, 配线整齐美观。

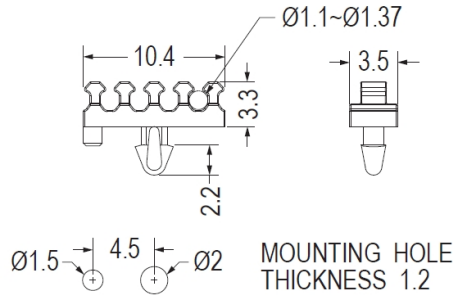

PART NO	PACKAGE
WS-T657	1000

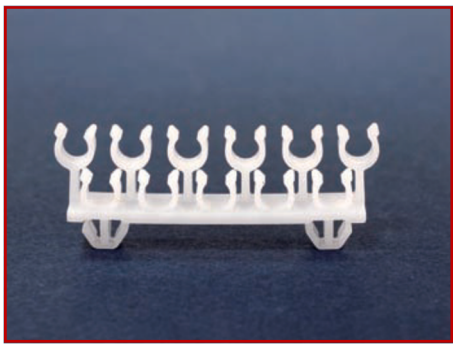

- ◆ MATERIAL : POM
- ◆ COLOR : NATURAL
- ◆ UNIT: mm

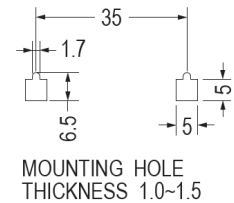

PART NO	PACKAGE
WS-T629	500

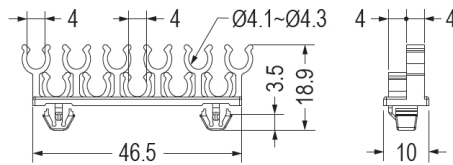

电线固定座 WIRE CILP 自粘式配线固定座 背胶式 螺丝固定

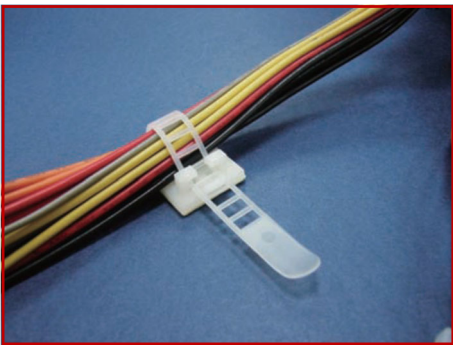

- ◆ MATERIAL : NYLON 66(UL)
- ◆ FLAME CLASS : 94V-2,94V-0
- ◆ COLOR : BLACK / NATURAL
- ◆ UNIT: mm

用途： 电线固定座,自粘式配线固定座可用背胶或螺丝固定, 可快速拆卸电线, 维修方便, 不占空间。

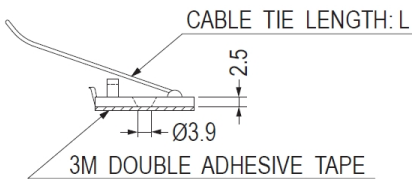
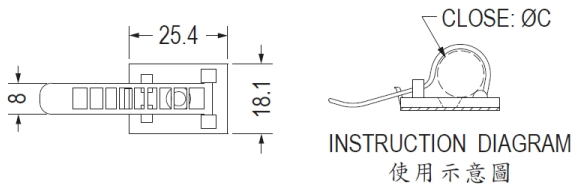
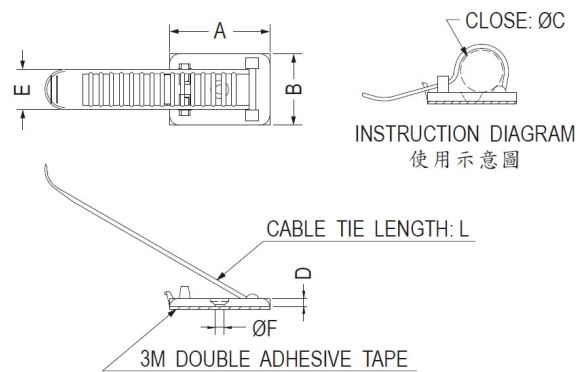

PART NO	C	L	PACKAGE
WS-T103	14.0	64.2	200
WS-T104	22.0	85.0	200

PART NO	A	B	C	D	E	F	L	PACKAGE
WS-T105	35.0	25.0	22.0	2.8	14.0	3.2	88.3	200
WS-T106	35.0	25.0	35.0	2.8	14.0	3.2	127.0	100
WS-T107	30.2	21.0	22.0	2.5	12.0	3.5	91.0	100
WS-T108	30.5	21.0	32.0	2.5	12.0	3.7	117.0	100
WS-T396	20.0	15.0	12.0	2.5	5.0	3.4	55.0	200
WS-T599	25.4	18.0	7.0	2.5	8.0	3.9	35.0	200

电线固定座 WIRE SADDLE 配线固定座

电线固定座

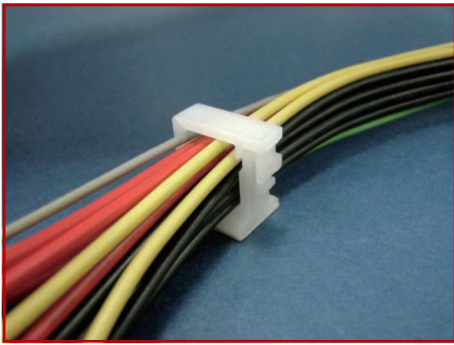

- ◆ MATERIAL : NYLON 66(UL)
- ◆ FLAME CLASS : 94V-2,94V-0
- ◆ COLOR : BLACK / NATURAL
- ◆ UNIT: mm

用途： 电线固定座,配线固定座卡槽式，可快速捆扎及解开电线。

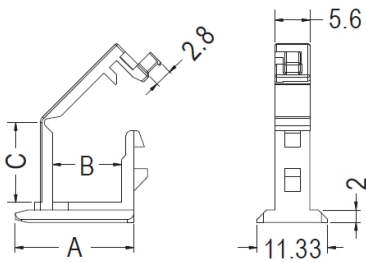

PART NO	A	B	C	PACKAGE
WS-T694	19.05	11.05	12.8	500

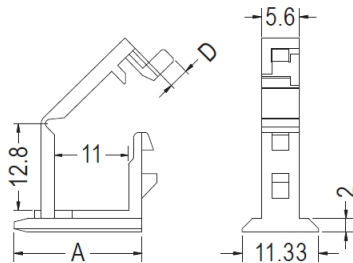

PART NO	A	D	PACKAGE
WS-T316	19.05	-	500
WS-T317	18.95	3.0	500

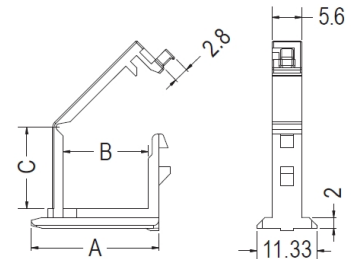

PART NO	A	B	C	PACKAGE
WS-T318	24.05	16.0	15.3	500
WS-T319	19.05	11.05	12.8	500

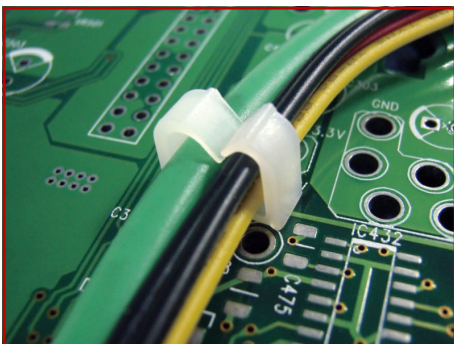

- ◆ MATERIAL : NYLON 66(UL)
- ◆ FLAME CLASS : 94V-2,94V-0
- ◆ COLOR : BLACK / NATURAL
- ◆ UNIT: mm

用途： 电线固定座,配线固定座固定电线于PC板或机板上，维修方便，不占空间。

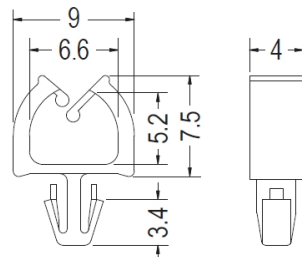

CHASSIS Ø3.0
THICKNESS 1.6

PART NO	PACKAGE
WS-T209	1000

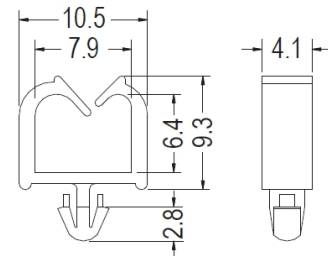

CHASSIS Ø3.0
THICKNESS 0.8~1.6

PART NO	PACKAGE
WS-T213	500

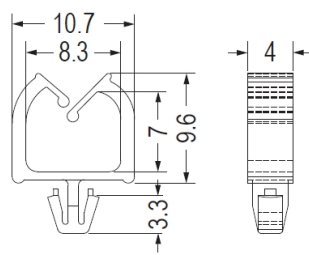
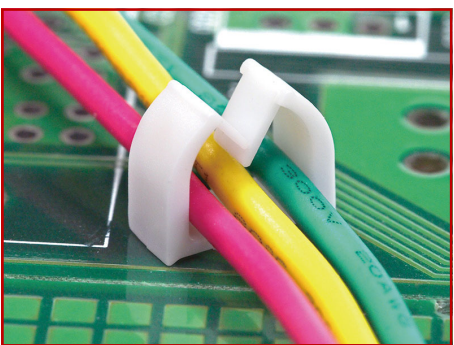

CHASSIS Ø3.3
THICKNESS 1.0

PART NO	PACKAGE
WS-T210	1000

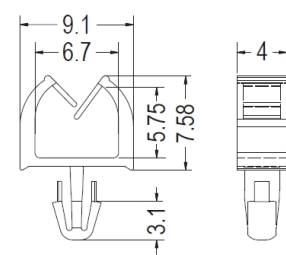

CHASSIS Ø3.0
THICKNESS 2.4

PART NO	PACKAGE
WS-T882	1000

电线固定座 WIRE SADDLE 配线固定座

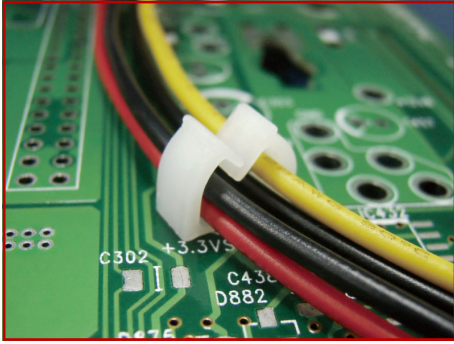

- ◆ MATERIAL : NYLON 66(UL)
- ◆ FLAME CLASS : 94V-2,94V-0
- ◆ COLOR : BLACK / NATURAL
- ◆ UNIT: mm

用途: 电线固定座,配线固定座固定电线于PC板或机板上, 维修方便, 不占空间。

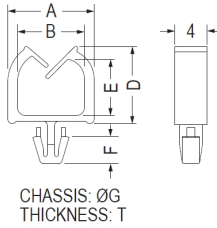

PART NO	A	B	D	E	F	G	T	PACKAGE
WS-T211	9.0	6.6	7.65	5.15	3.2	3.5	1.6	1000
WS-T212	9.0	6.6	7.65	5.15	2.8	3.5	1.0	1000
WS-T217	10.7	8.3	9.6	7.0	3.4	3.0	1.6	1000
WS-T218	10.7	8.3	9.6	7.0	2.4	3.0	1.6	1000

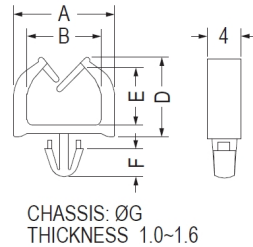
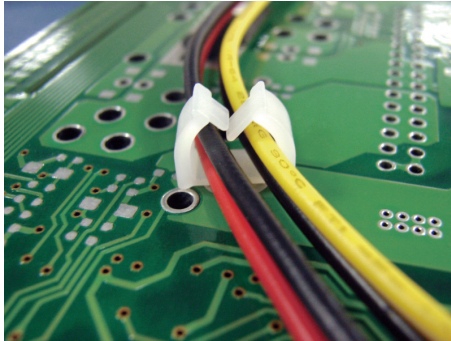

PART NO	A	B	D	E	F	G	PACKAGE
WS-T238	12.0	8.8	11.0	8.5	2.8	3.5	1000
WS-T239	9.2	6.8	7.6	5.0	2.7	3.0	2000
WS-T429	12.0	9.0	11.5	8.48	2.8	3.5	1000

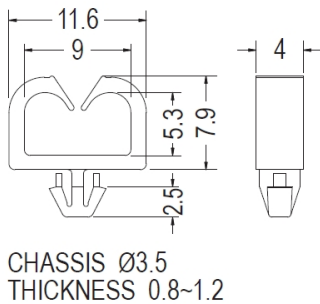
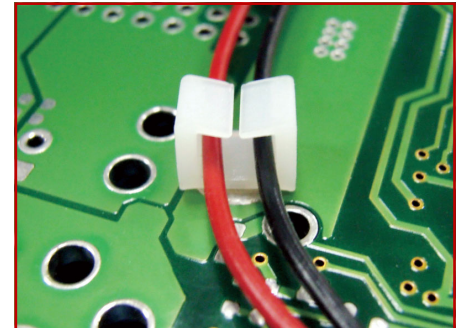
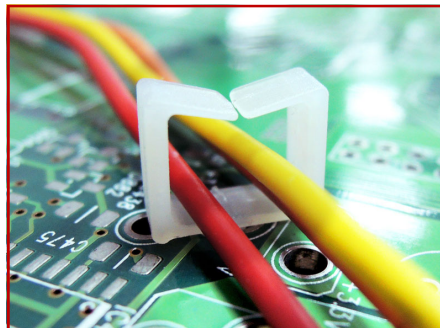
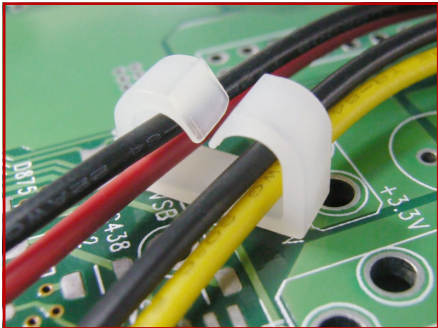

PART NO	PACKAGE
WS-T222	1000

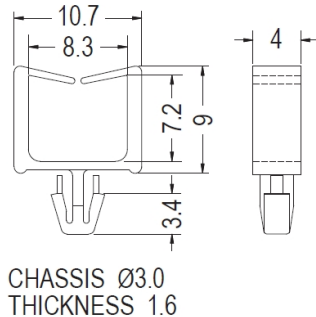

PART NO	PACKAGE
WS-T430	1000

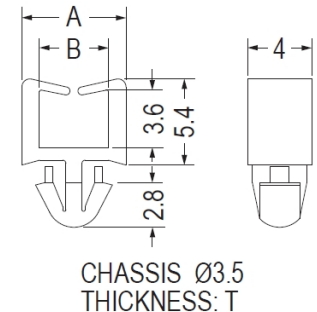

PART NO	A	B	T	PACKAGE
WS-T214	6.5	4.3	1.0	1000
WS-T215	6.5	4.3	4.0	1000
WS-T216	7.8	5.6	1.5	1000

电线固定座 WIRE SADDLE 配线固定座

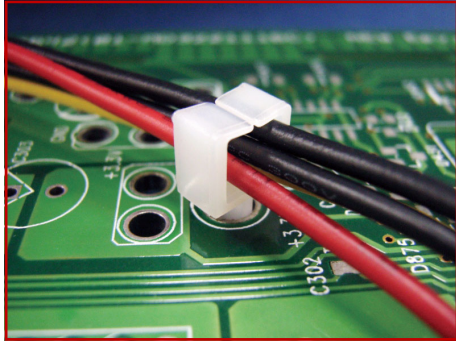

- ◆ MATERIAL : NYLON 66(UL)
- ◆ FLAME CLASS : 94V-2,94V-0
- ◆ COLOR : BLACK / NATURAL
- ◆ UNIT: mm

用途： 电线固定座,配线固定座用于电子、计算机内部电线固定，装配容易，美观不脱落。

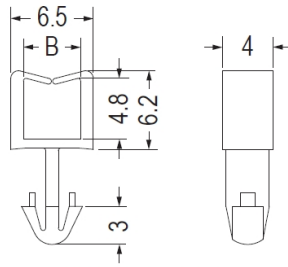

CHASSIS Ø3.5
THICKNESS: T

PART NO	B	T	PACKAGE
WS-T225	4.5	4.0	1000
WS-T227	4.3	2.5	1000

电线固定座

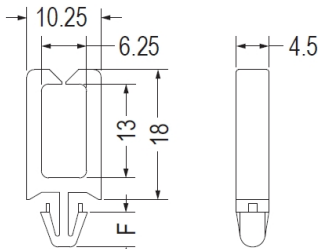
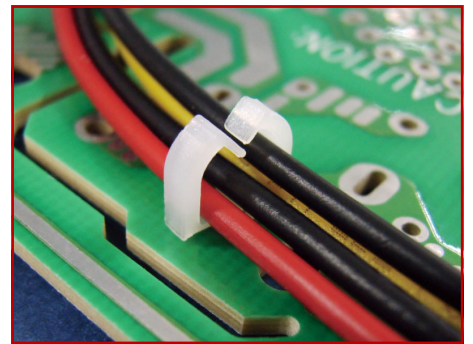
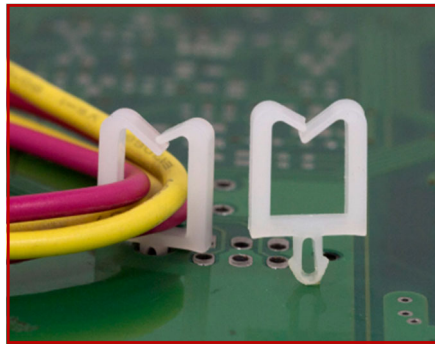
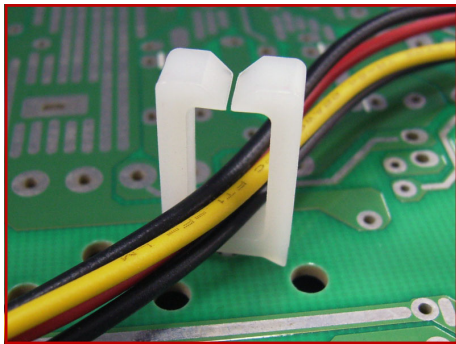

CHASSIS: ØG
THICKNESS: T

PART NO	F	G	T	PACKAGE
WS-T091	4.8	4.8	1.8	1000
WS-T092	2.5	3.0	1.6	1000

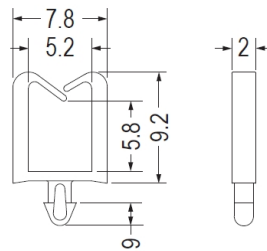

MOUNTING HOLE Ø2.0
THICKNESS: T

PART NO	T	PACKAGE
WS-T696	1.6	2000
WS-T697	0.8	2000
WS-T698	2.0	2000

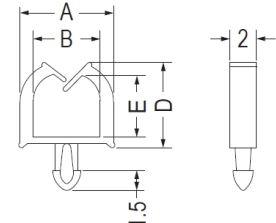

P.C.B Ø1.75
THICKNESS 1.6

PART NO	A	B	D	E	PACKAGE
WS-T221	7.0	5.0	6.4	4.6	2000
WS-T603	8.5	6.5	7.0	5.2	2000

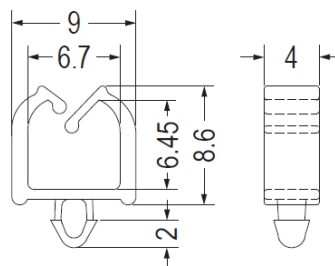
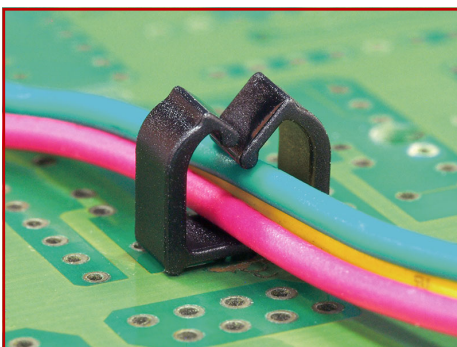

CHASSIS Ø3.0
THICKNESS 1.1

PART NO	PACKAGE
WS-T626	200

电线固定座 WIRE SADDLE 配线固定座

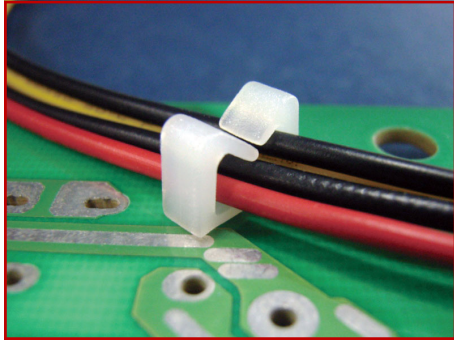

- ◆ MATERIAL : NYLON 66(UL)
- ◆ FLAME CLASS : 94V-2,94V-0
- ◆ COLOR : BLACK / NATURAL
- ◆ UNIT: mm

用途: 电线固定座,配线固定座固定电线于PC板或机板上, 维修方便, 不占空间。

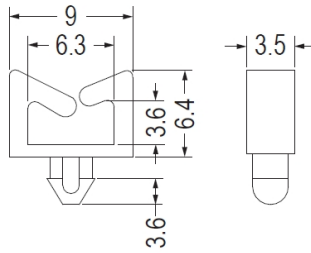

CHASSIS Ø3.0
THICKNESS 1.2~1.6

PART NO	PACKAGE
WS-T208	2000

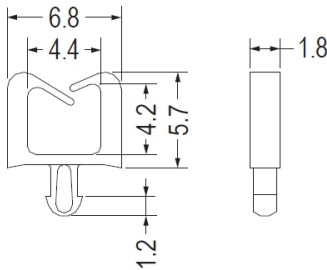
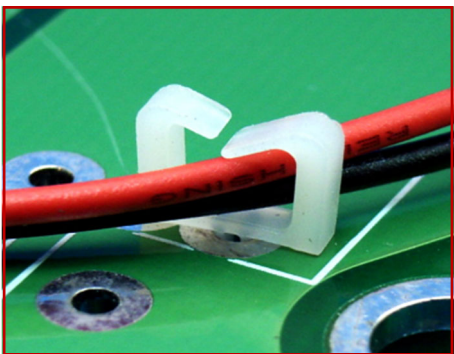

P.C.B Ø1.75
THICKNESS 1.6

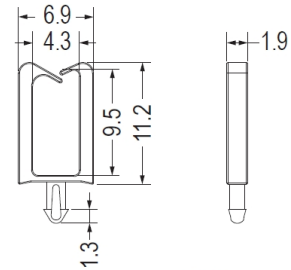

CHASSIS Ø1.75
THICKNESS 2.2

PART NO	PACKAGE
WS-T219	2000

PART NO	PACKAGE
WS-T660	2000

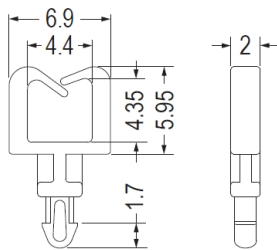
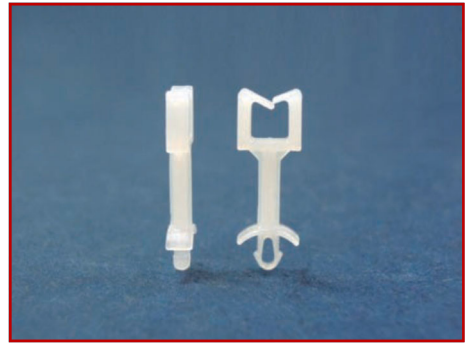
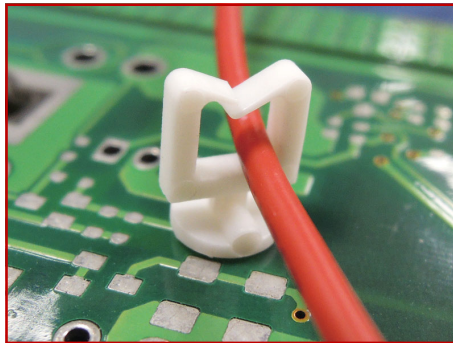
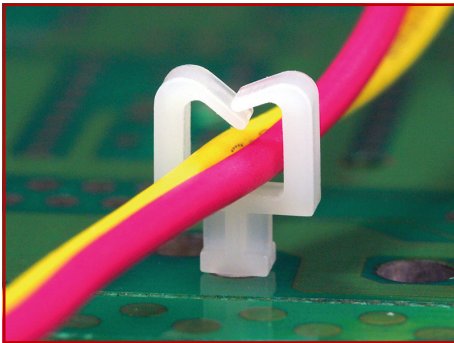

CHASSIS Ø2.0
THICKNESS 1.6

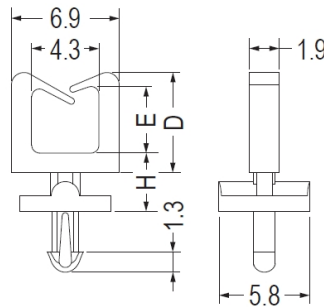

CHASSIS: ØG
THICKNESS: T

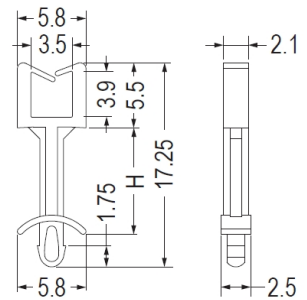

CHASSIS Ø2.0
THICKNESS 1.6~1.8

PART NO	PACKAGE
WS-T627	1000

PART NO	D	E	G	H	T	PACKAGE
WS-T486	6.4	4.26	1.8	3.73	2.4	1000
WS-T606	7.3	5.1	1.78	6.4	1.57	1000

PART NO	H	PACKAGE
WS-T498	9.0	1000
WS-T499	7.0	1000
WS-T904	15.0	1000

电线固定座 WIRE SADDLE 配线固定座



- ◆ MATERIAL : NYLON 66(UL)
- ◆ FLAME CLASS : 94V-2,94V-0
- ◆ COLOR : BLACK / NATURAL
- ◆ UNIT: mm

用途： 电线固定座,配线固定座固定电线于PC板或机板上， 维修方便， 不占空间。

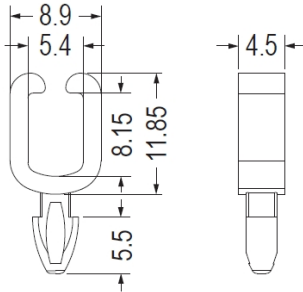

CHASSIS Ø4.0
THICKNESS 2.2

PART NO	PACKAGE
WS-T230	2000

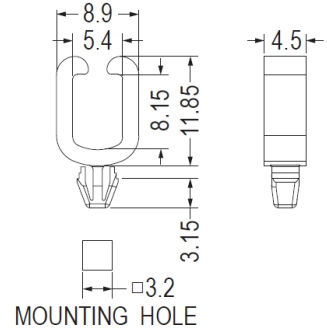

MOUNTING HOLE
□3.2

PART NO	PACKAGE
WS-T699	2000

电线固定座

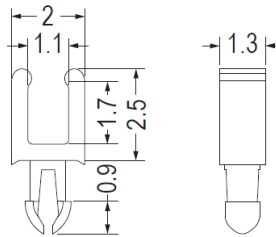

MOUNTING HOLE Ø1.0
THICKNESS 1.0

PART NO	PACKAGE
WS-T579	1000

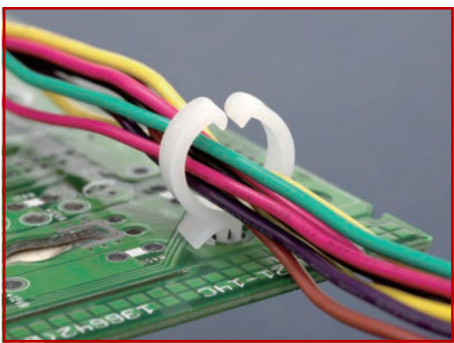

- ◆ MATERIAL : NYLON 6(UL)
- ◆ FLAME CLASS : 94V-2
- ◆ COLOR : NATURAL
- ◆ UNIT: mm

用途： 电线固定座,配线固定座固定电线于PC板或机板上， 维修方便， 不占空间。

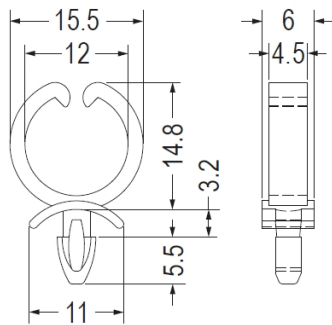

CHASSIS: ØG
THICKNESS 0.8-2.2

PART NO	T	PACKAGE
WS-T071	3.5	1000
WS-T601	3.2	1000

电线固定座 WIRE SADDLE 配线固定座



- ◆ MATERIAL : NYLON 66(UL)
- ◆ FLAME CLASS : 94V-2,94V-0
- ◆ COLOR : BLACK / NATURAL
- ◆ UNIT: mm

用途: 电线固定座,配线固定座固定电线于PC板或机板上, 维修方便, 不占空间。

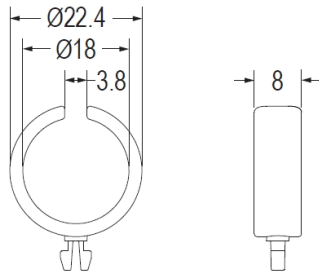

CHASSIS Ø4.0
THICKNESS 2.5

PART NO	PACKAGE
WS-T251	500

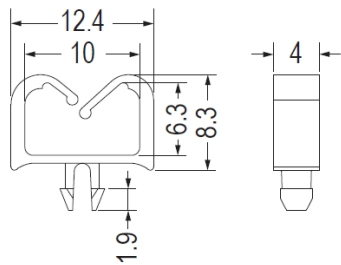
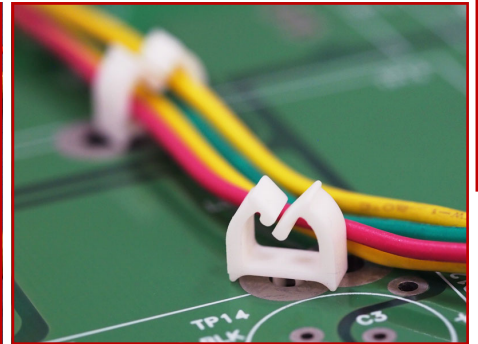
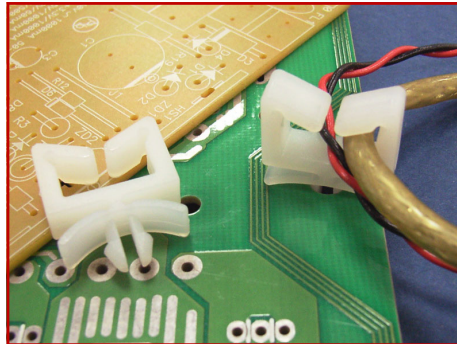
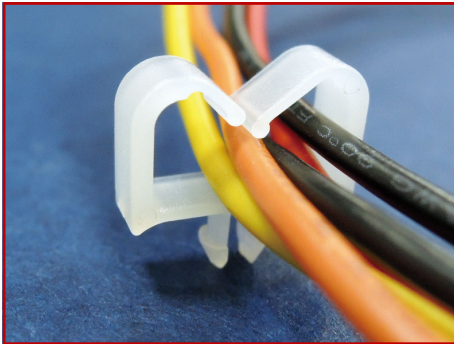

CHASSIS Ø3.0
THICKNESS: T

PART NO	T	PACKAGE
WS-T487	1.5	1000
WS-T488	2.0	1000

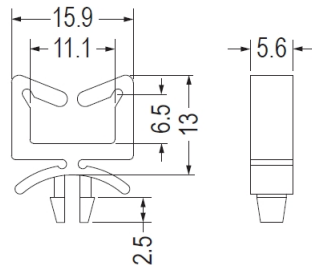

CHASSIS: ØG
THICKNESS 0.8~1.6

PART NO	T	PACKAGE
WS-T067	4.8	1000
WS-T068	4.4	1000

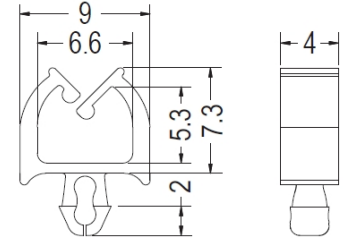

P.C.B Ø3.0
THICKNESS 1.2~1.6

PART NO	PACKAGE
WS-T242	1000

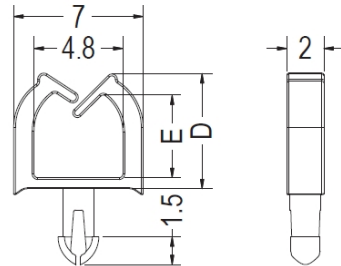
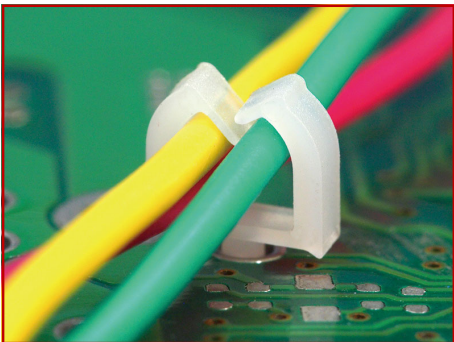

MOUNTING HOLE Ø1.7
THICKNESS: T

PART NO	D	E	T	PACKAGE
WS-T561	6.3	4.46	2.4	1000
WS-T611	4.0	2.2	2.4	1000
WS-T612	4.0	2.2	1.6	1000
WS-T613	6.0	4.2	1.6	1000

电线固定座

电线固定座 WIRE SADDLE 配线固定座

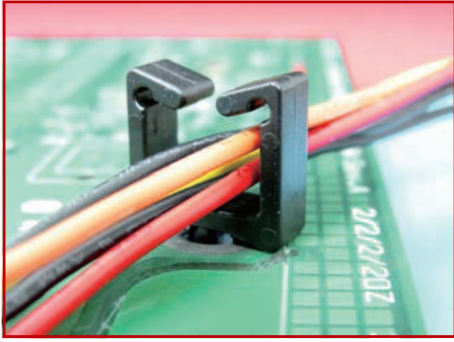

- ◆ MATERIAL : NYLON 66(UL)
- ◆ FLAME CLASS : 94V-2,94V-0
- ◆ COLOR : BLACK / NATURAL
- ◆ UNIT: mm

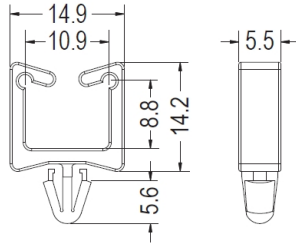

CHASSIS Ø4.8
THICKNESS 1.1

用途： 电线固定座,配线固定座固定电线于PC板或机板上，维修方便，不占空间。

PART NO	PACKAGE
WS-T070	1000

电线固定座

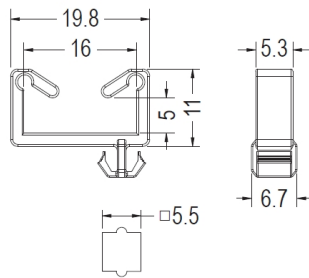
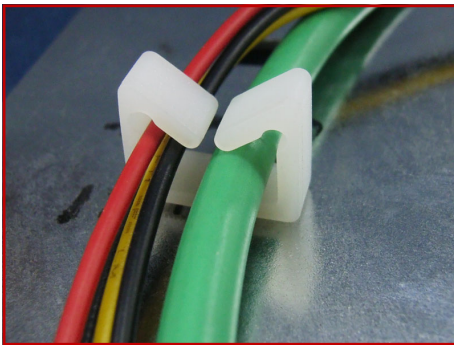

MOUNTING HOLE
THICKNESS 1.6

PART NO	PACKAGE
WS-T701	1000

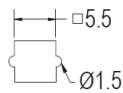
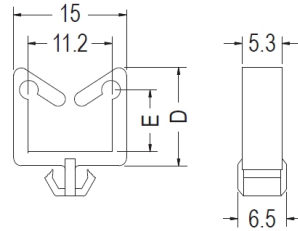
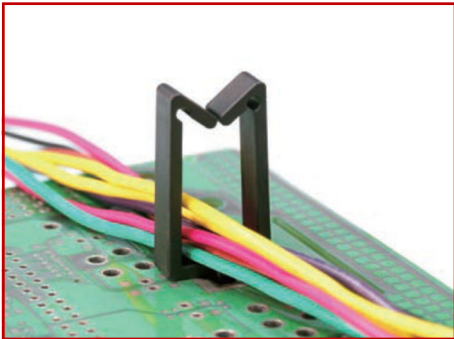

MOUNTING HOLE
THICKNESS 1.0

PART NO	D	E	PACKAGE
WS-T058	12.0	7.2	1000
WS-T059	17.0	12.2	500
WS-T060	26.0	21.2	500

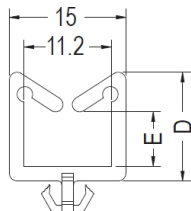

MOUNTING HOLE
THICKNESS 0.5-0.8

WS-T661

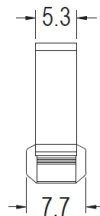

MOUNTING HOLE
THICKNESS 0.8-1.0

WS-T700

PART NO	D	E	PACKAGE
WS-T661	12.0	5.0	1000
WS-T700	14.0	7.0	100

电线固定座 WIRE SADDLE 配线固定座

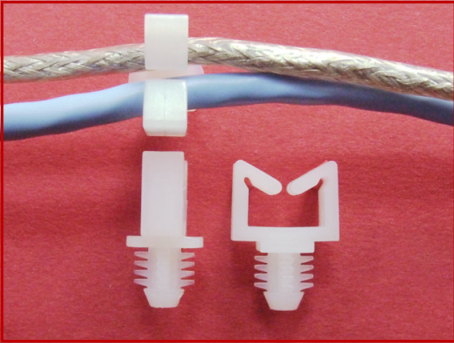

- ◆ MATERIAL : NYLON 66(UL)
- ◆ FLAME CLASS : 94V-2,94V-0
- ◆ COLOR : BLACK / NATURAL
- ◆ UNIT: mm

用途: 电线固定座,配线固定座固定电线于木板或机壳上, 维修方便, 不占空间。

PART NO	A	C	D	E	F	PACKAGE
WS-T466	15.1	11.0	13.0	6.7	8.5	1000
WS-T467	15.5	11.1	18.3	12.3	8.5	1000
WS-T468	15.1	11.0	3.5.0	28.7	8.5	1000
WS-T469	15.1	11.1	27.2	21.0	8.7	1000

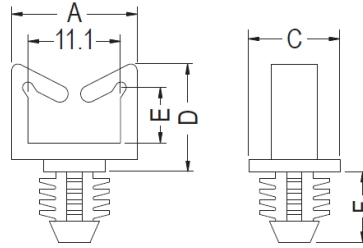

CHASSIS Ø7.9
THICKNESS 6.4

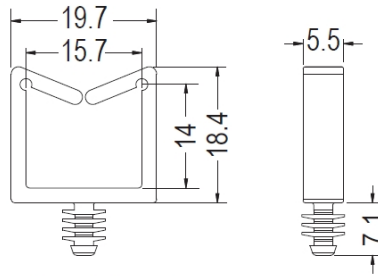
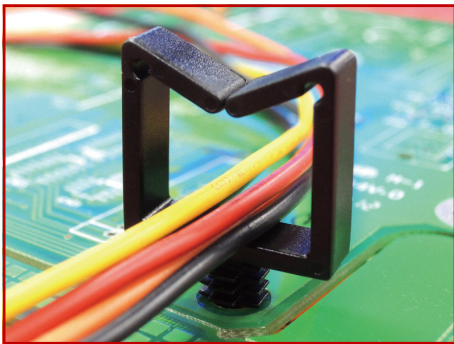

CHASSIS Ø5.3

PART NO	PACKAGE
WS-T529	1000

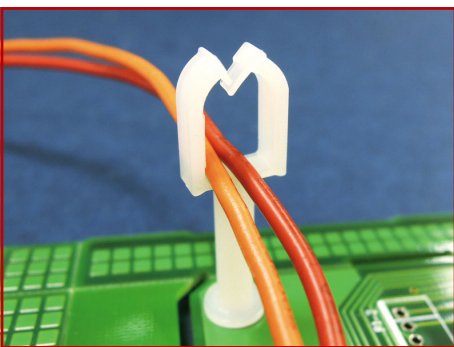

- ◆ MATERIAL : NYLON 66(UL)
- ◆ FLAME CLASS : 94V-2,94V-0
- ◆ COLOR : BLACK / NATURAL
- ◆ UNIT: mm

用途: 电线固定座,配线固定座固定电线于PC板或机板上, 维修方便, 不占空间。

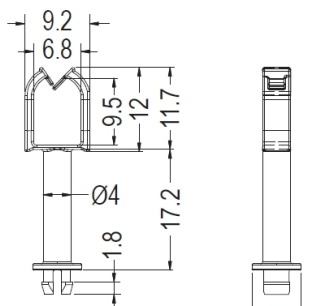

CHASSIS Ø3.8
THICKNESS 1.7

PART NO	PACKAGE
WS-T491	1000

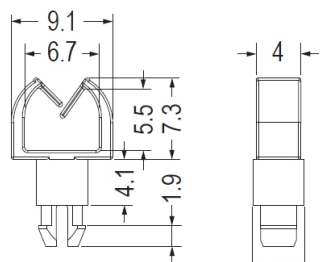
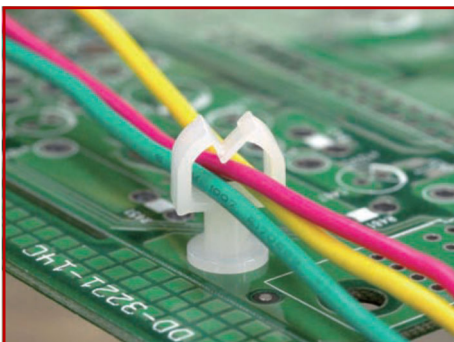

CHASSIS Ø3.8
THICKNESS 1.6

PART NO	PACKAGE
WS-T500	1000

电线固定座 WIRE SADDLE 配线固定座

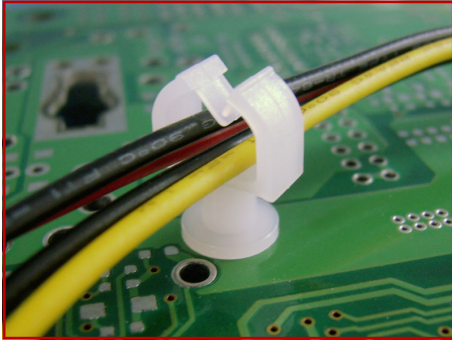

- ◆ MATERIAL : NYLON 66(UL)
- ◆ FLAME CLASS : 94V-2,94V-0
- ◆ COLOR : BLACK / NATURAL
- ◆ UNIT: mm

用途： 电线固定座,配线固定座固定电线于PC板或机板上，维修方便，不占空间。

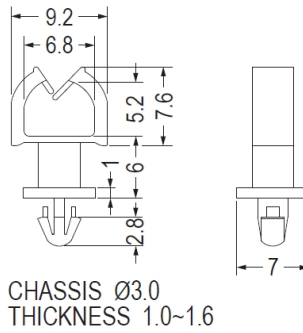

PART NO	PACKAGE
WS-T243	1000

电线固定座

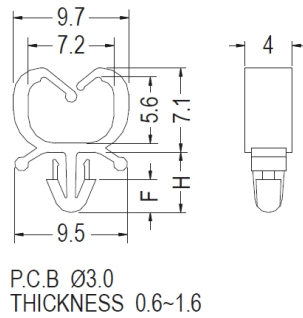
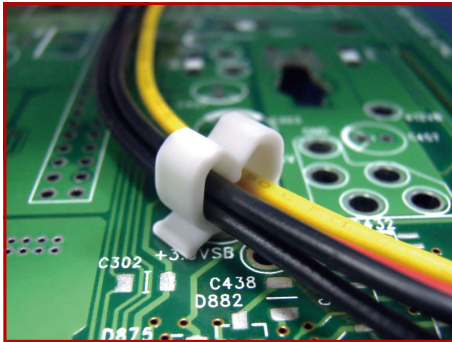

PART NO	D	E	PACKAGE
WS-T207	2.8	5.1	2000
WS-T431	2.2	4.5	2000

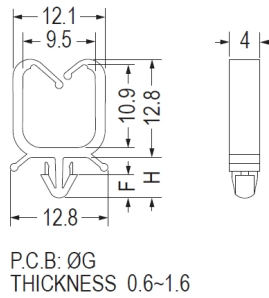
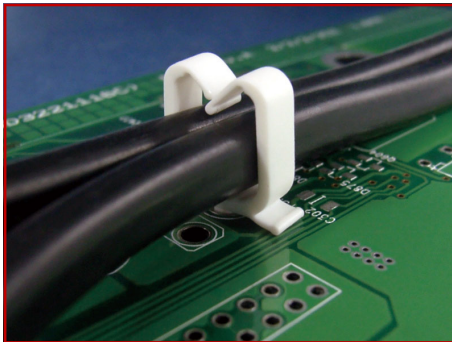

PART NO	D	E	G	PACKAGE
WS-T206	3.0	3.5	5.3	2000
WS-T432	3.2	3.0	4.5	2000

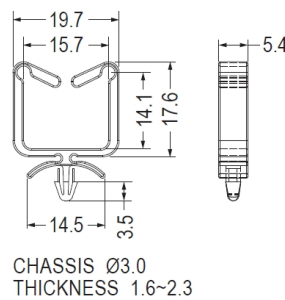
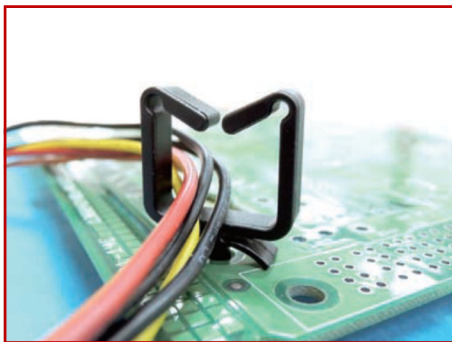

PART NO	PACKAGE
WS-T438	500

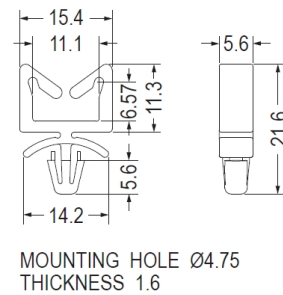

PART NO	PACKAGE
WS-T703	1000

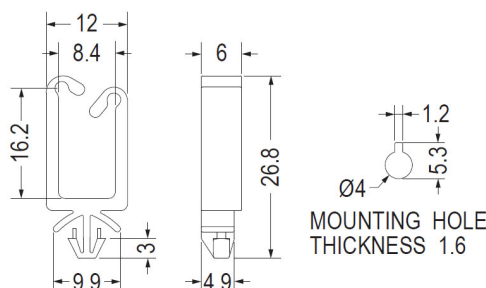

PART NO	PACKAGE
WS-T905	1000

电线固定座 WIRE SADDLE 配线固定座

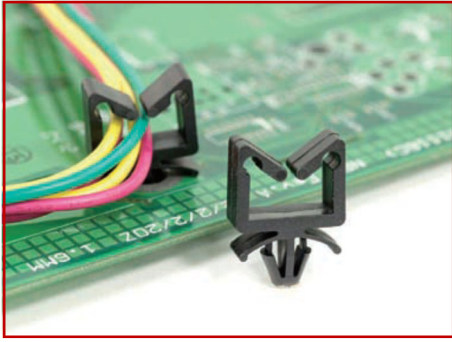

- ◆ MATERIAL : NYLON 66(UL)
- ◆ FLAME CLASS : 94V-2,94V-0
- ◆ COLOR : BLACK / NATURAL
- ◆ UNIT: mm

用途: 电线固定座,配线固定座固定电线于PC板或机板上, 维修方便, 不占空间。



WS-T662

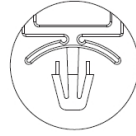

WS-T065

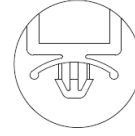

WS-T434



WS-T435

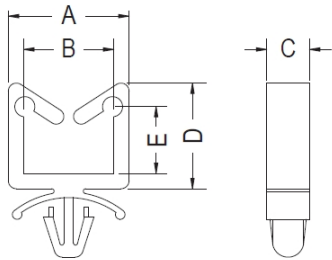

CHASSIS: ØG
THICKNESS: T

PART NO	A	B	C	D	E	G	T	PACKAGE
WS-T061	15.0	11.2	5.3	12.0	7.2	4.8~5.0	0.8~2.0	1000
WS-T062	15.0	11.2	5.3	17.0	12.2	4.8~5.0	0.8~2.0	500
WS-T063	15.0	11.2	5.3	26.0	21.2	4.8~5.0	0.8~2.0	500
WS-T064	15.0	11.2	5.3	34.0	29.2	4.8~5.0	0.8~2.0	500
WS-T065	15.1	11.1	5.6	17.8	11.65	4.75	1.6~3.2	500
WS-T434	15.0	11.2	5.3	17.0	12.2	4.8	0.8~2.2	500
WS-T435	15.0	10.6	5.2	20.0	15.3	4.8	0.8~2.2	500
WS-T436	15.0	11.2	5.3	12.0	7.2	4.8~5.0	2.2	1000
WS-T437	15.0	11.2	5.3	17.0	12.2	4.8	0.8~2.5	500
WS-T662	15.0	11.2	5.3	26.0	21.2	4.8~5.0	3.0	500
WS-T702	15.0	11.2	5.3	12.0	7.2	5.4	0.8~2.0	500

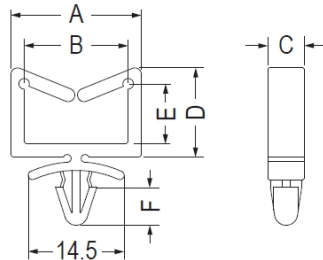
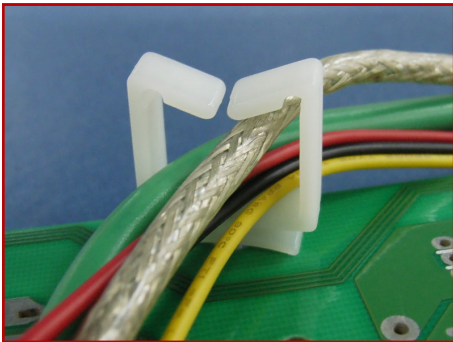

CHASSIS: ØG
THICKNESS: T

PART NO	A	B	C	D	E	F	G	T	PACKAGE
WS-T081	18.5	14.6	5.5	17.0	12.55	6.1	5.0	1.2~2.0	500
WS-T441	19.5	15.7	5.4	18.2	14.0	5.7	4.8~5.0	1.2~2.1	500
WS-T442	15.0	11.0	5.5	17.0	12.6	5.7	4.8~5.0	1.2~2.1	500

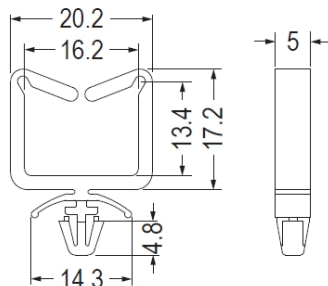
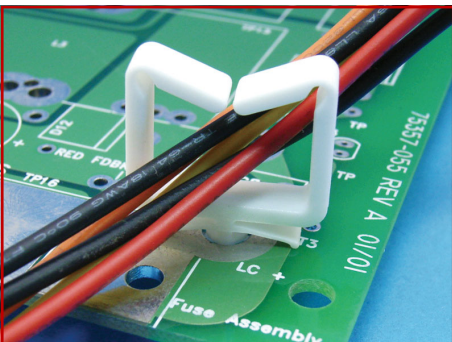

CHASSIS Ø4.8
THICKNESS 1.0~2.5

PART NO	PACKAGE
WS-T889	500

电线固定座

电线固定座 WIRE SADDLE 配线固定座

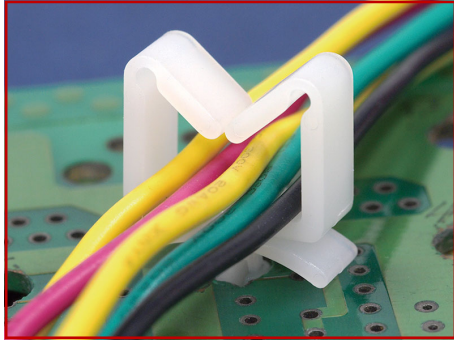

- ◆ MATERIAL : NYLON 66(UL)
- ◆ FLAME CLASS : 94V-2,94V-0
- ◆ COLOR : BLACK / NATURAL
- ◆ UNIT: mm

用途： 电线固定座,配线固定座固定电线于PC板或机板上， 维修方便， 不占空间。

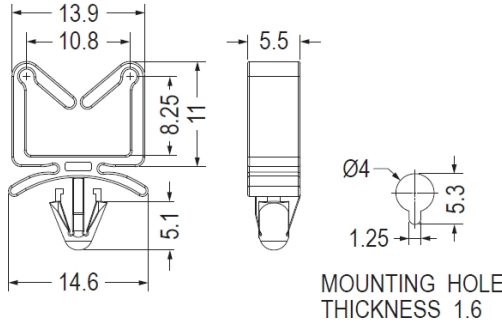

PART NO	PACKAGE
WS-T628	1000

电线固定座

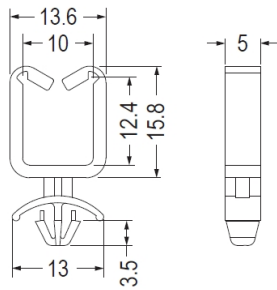
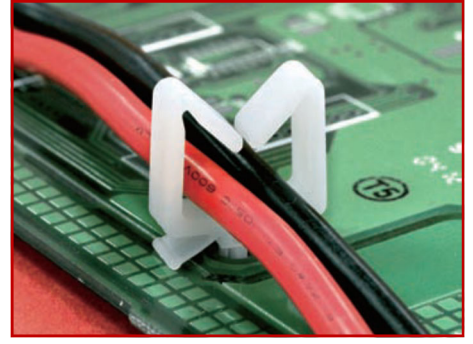
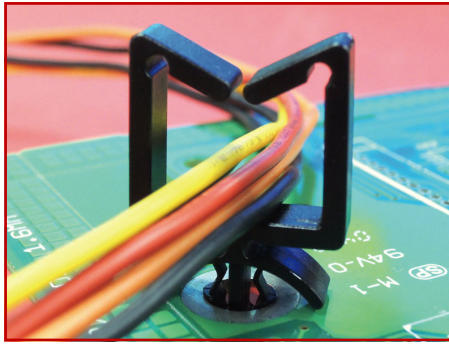
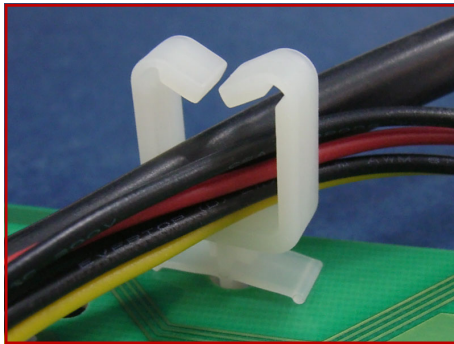

CHASSIS Ø5.0
THICKNESS 0.8~1.6

PART NO	PACKAGE
WS-T090	1000

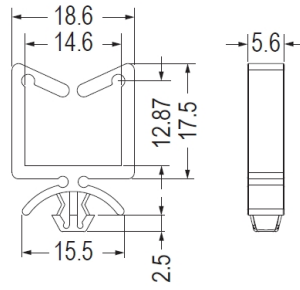

CHASSIS Ø5.0
THICKNESS 2.4~3.0

PART NO	PACKAGE
WS-T501	1000

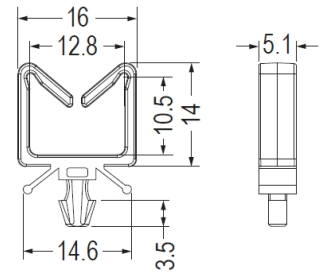

CHASSIS Ø3.4~Ø3.5
THICKNESS 2.5

PART NO	PACKAGE
WS-T539	1000

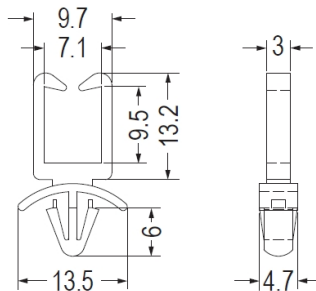
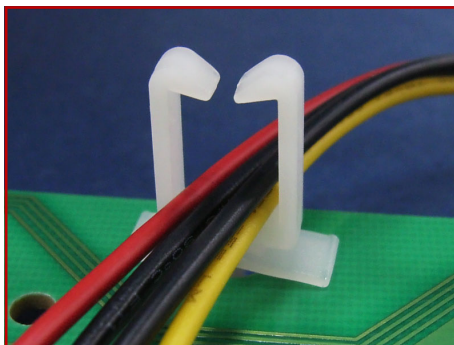

CHASSIS Ø4.8
THICKNESS 0.8~1.6

PART NO	PACKAGE
WS-T066	1000

电线固定座 WIRE SADDLE 配线固定座

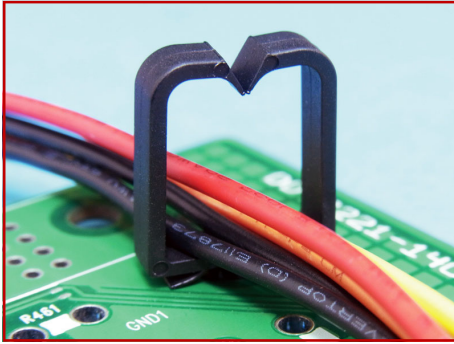

- ◆ MATERIAL : NYLON 66(UL)
- ◆ FLAME CLASS : 94V-2,94V-0
- ◆ COLOR : BLACK / NATURAL
- ◆ UNIT: mm

用途：电线固定座,配线固定座固定电线于PC板或机板上，维修方便，不占空间。

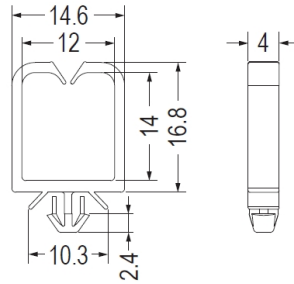

CHASSIS Ø4.0
THICKNESS 0.8-2.0

PART NO	PACKAGE
WS-T235	500

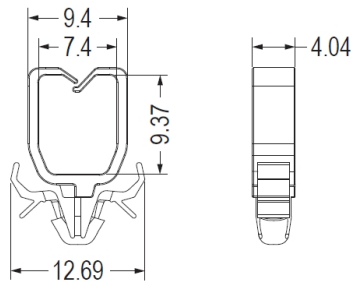
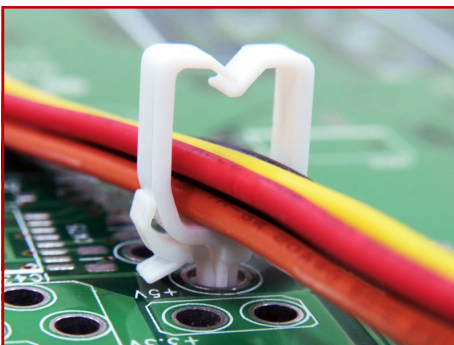

CHASSIS Ø3.5
THICKNESS 0.6-1.6

PART NO	PACKAGE
WS-T241	2000

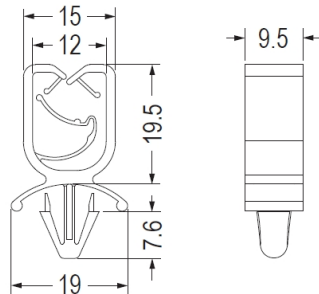
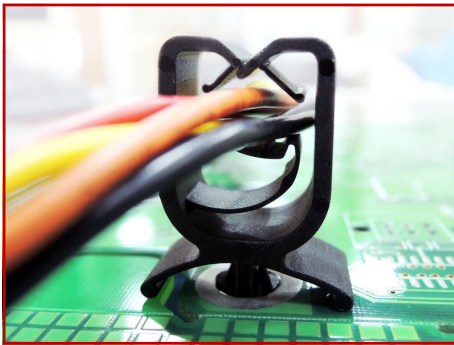

CHASSIS Ø6.3-Ø7.0
THICKNESS 0.6-3.0

PART NO	PACKAGE
WS-T433	1000

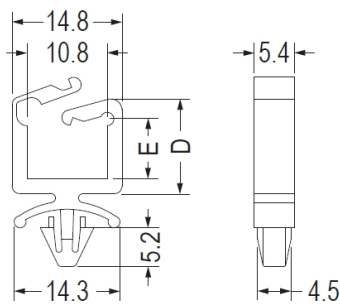
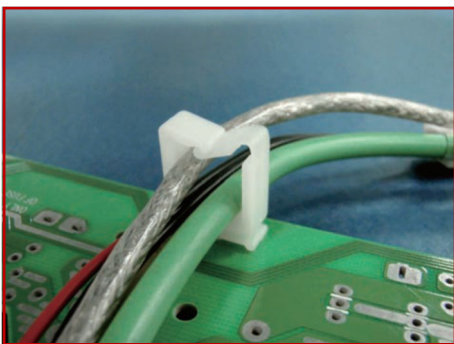

CHASSIS Ø4.8-Ø5.0
THICKNESS 0.5-2.0

PART NO	D	E	PACKAGE
WS-T051	15.9	11.2	500
WS-T052	25.2	20.5	500

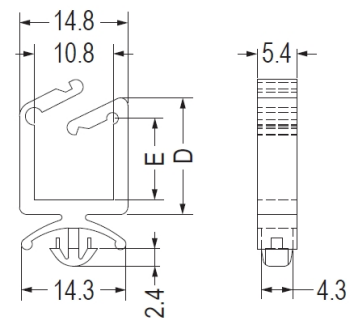

CHASSIS Ø4.8
THICKNESS 0.8-1.6

PART NO	D	E	PACKAGE
WS-T053	15.9	11.1	500
WS-T054	20.6	15.8	500

电线固定座

电线固定座 WIRE SADDLE 配线固定座

用途： 电线固定座,配线固定座固定电
线于PC板或机板上，维修方
便，不占空间。

- ◆ MATERIAL : NYLON 66(UL)
- ◆ FLAME CLASS : 94V-2,94V-0
- ◆ COLOR : BLACK / NATURAL
- ◆ UNIT: mm

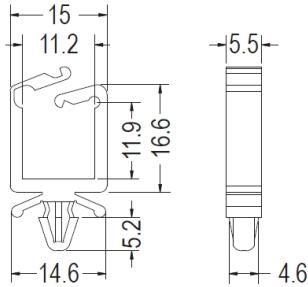

CHASSIS Ø4.8
THICKNESS 0.8-1.8

PART NO	PACKAGE
WS-T055	500

电线固定座

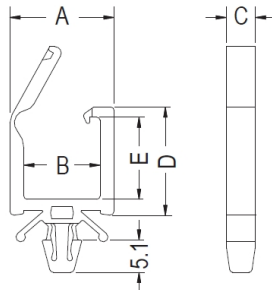

CHASSIS Ø4.8
THICKNESS 0.5-2.0

PART NO	A	B	C	D	E	PACKAGE
WS-T785	16.4	12.0	4.6	21.5	17.4	500
WS-T786	14.4	10.4	4.6	16.5	12.4	500
WS-T787	18.4	14.0	5.0	24.0	20.0	500

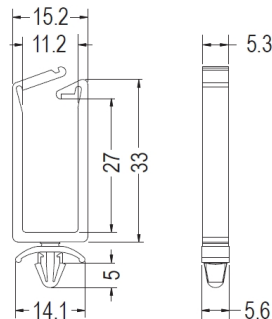
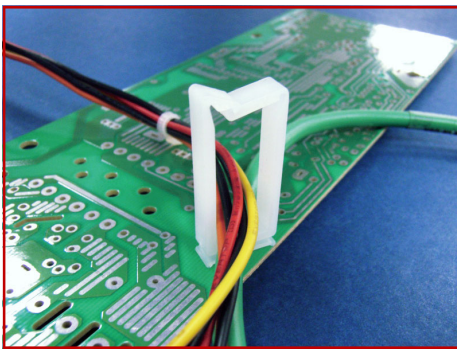

CHASSIS Ø4.8
THICKNESS: T

PART NO	T	PACKAGE
WS-T056	0.5~2.3	500
WS-T446	1.5~3.0	500

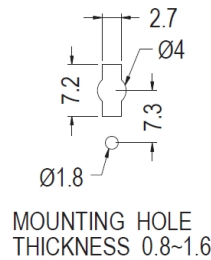
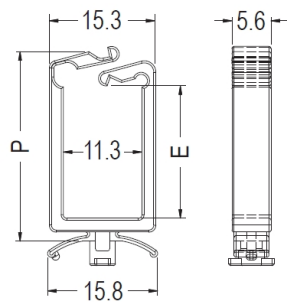

PART NO	E	P	PACKAGE
WS-T447	4.8	13.0	500
WS-T448	9.8	18.8	500
WS-T449	19.0	27.2	500
WS-T450	26.8	35.1	500

电线固定座 WIRE SADDLE 配线固定座

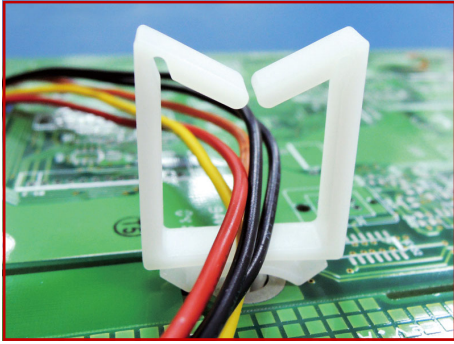

- ◆ MATERIAL : NYLON 66(UL)
- ◆ FLAME CLASS : 94V-2,94V-0
- ◆ COLOR : BLACK / NATURAL
- ◆ UNIT: mm

用途：电线固定座,配线固定座固定电线于PC板或机板上，维修方便，不占空间。

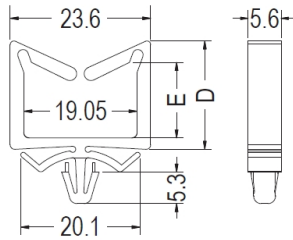

HOLE \varnothing 4.75
THICKNESS 1.2

PART NO	D	E	PACKAGE
WS-T439	18.2	12.7	500
WS-T440	27.1	21.6	500

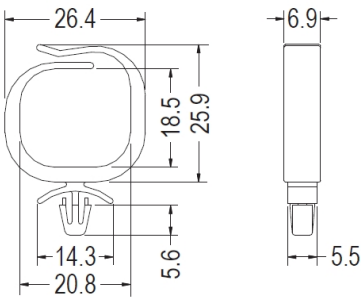
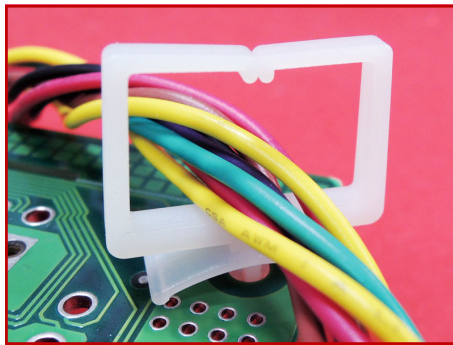
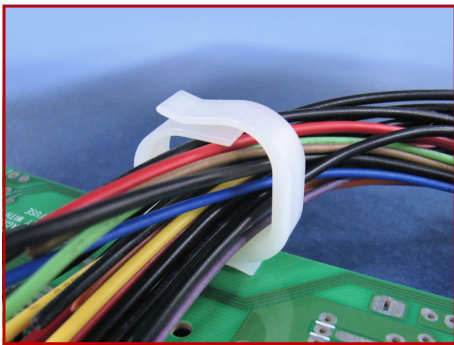

CHASSIS \varnothing 4.8- \varnothing 5.5
THICKNESS 0.8-2.0

PART NO	PACKAGE
WS-T782	250

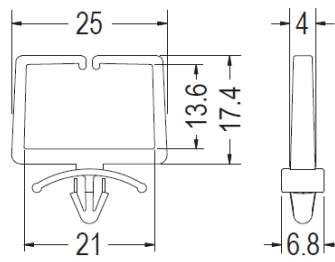

CHASSIS \varnothing 4.8- \varnothing 5.0
THICKNESS 0.8-2.5

PART NO	PACKAGE
WS-T490	500

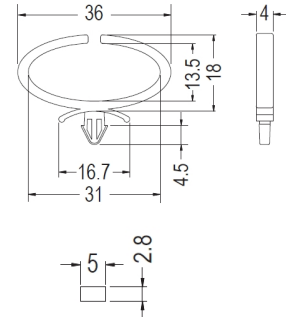

MOUNTING HOLE
THICKNESS 0.8-2.0

PART NO	PACKAGE
WS-T359	1000

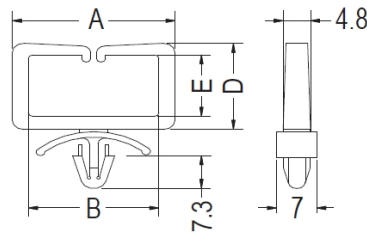
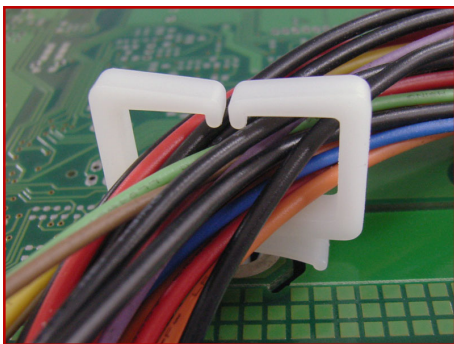

CHASSIS \varnothing 4.8- \varnothing 5.0
THICKNESS: T

PART NO	A	B	D	E	T	PACKAGE
WS-T890	28.5	22.9	19.2	13.6	1.1~3.5	500
WS-T891	42.0	36.0	66.0	60.3	0.8~4.0	500

电线固定座

电线固定座 WIRE SADDLE 配线固定座

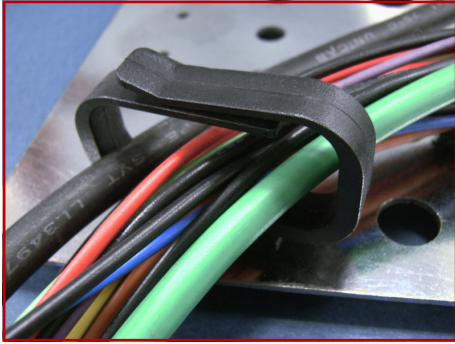

- ◆ MATERIAL : NYLON 66(UL)
- ◆ FLAME CLASS : 94V-2,94V-0
- ◆ COLOR : BLACK / NATURAL
- ◆ UNIT: mm

用途： 电线固定座,配线固定座固定电线于PC板或机板上，维修方便，不占空间。

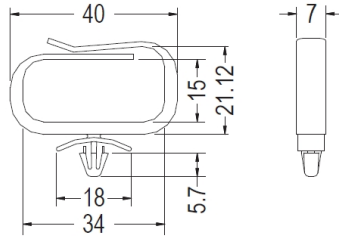

CHASSIS \varnothing 4.8- \varnothing 5.5
THICKNESS 0.8-2.0

PART NO	PACKAGE
WS-T784	250

电线固定座

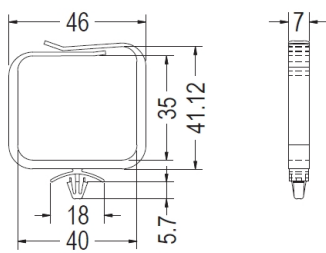
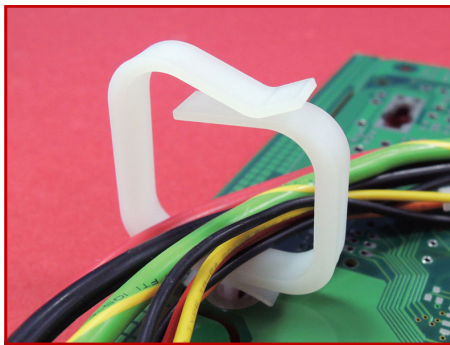
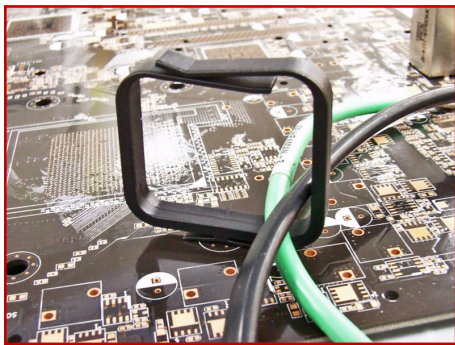

CHASSIS \varnothing 4.8
THICKNESS 0.8-2.0

PART NO	PACKAGE
WS-T072	200

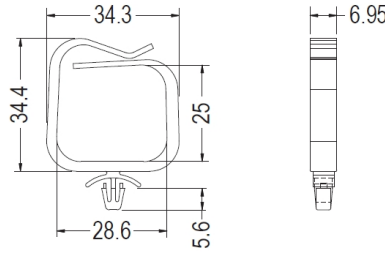

CHASSIS \varnothing 4.8
THICKNESS 0.8-2.0

PART NO	PACKAGE
WS-T862	250

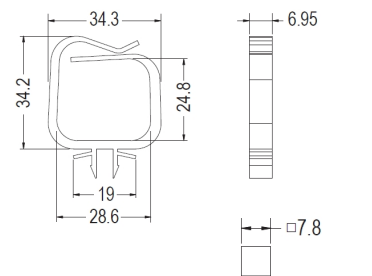

MOUNTING HOLE
THICKNESS 0.8-2.0

PART NO	PACKAGE
WS-T783	250

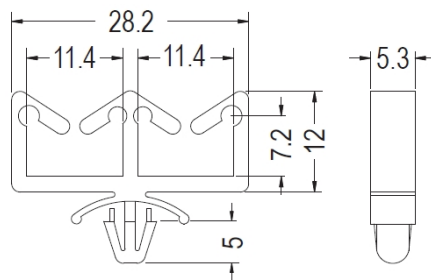
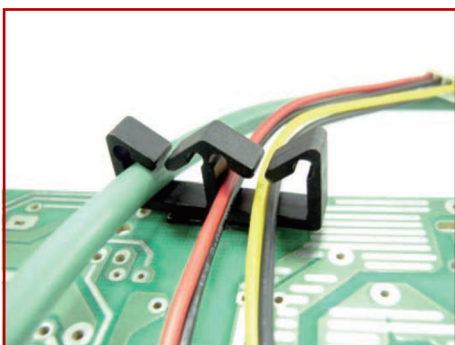

WS-T704

CHASSIS: \varnothing G
THICKNESS 1.2-2.1

PART NO	G	PACKAGE
WS-T057	4.8~5.0	1000
WS-T704	4.8	1000

电线固定座 WIRE SADDLE 配线固定座

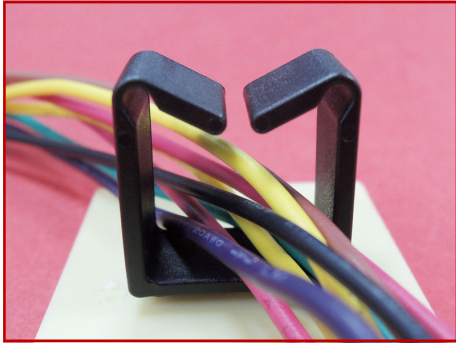

- ◆ MATERIAL : NYLON 66(UL)
- ◆ FLAME CLASS : 94V-2,94V-0
- ◆ COLOR : BLACK / NATURAL
- ◆ UNIT: mm

用途: 电线固定座,配线固定座固定电线于PC板或机板上, 维修方便, 不占空间。

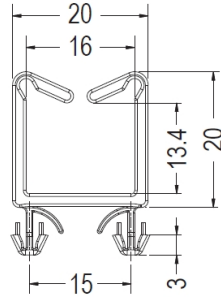

HOLE Ø4.0
THICKNESS 0.8~2.5

PART NO	PACKAGE
WS-T489	1000

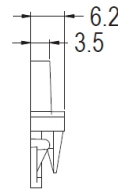
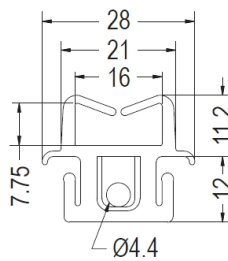
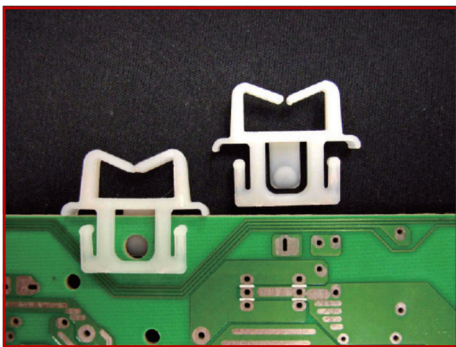

MOUNTING DETAIL

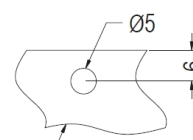

PANEL THICKNESS 1.0~2.0

PART NO	PACKAGE
WS-T131	500

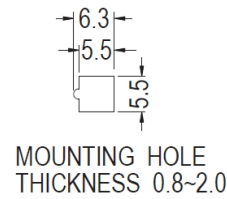
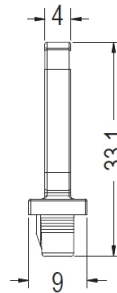
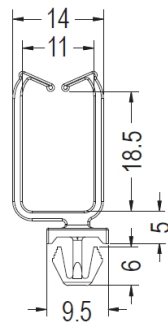
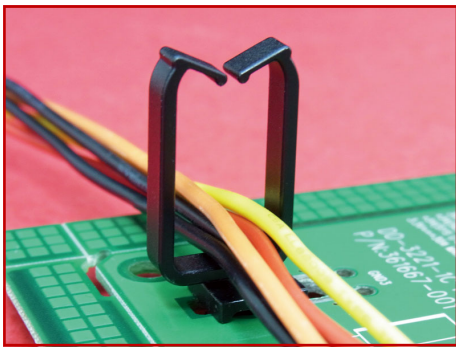

MOUNTING HOLE
THICKNESS 0.8~2.0

PART NO	PACKAGE
WS-T348	500



- ◆ MATERIAL : NYLON 66(UL)
- ◆ FLAME CLASS : 94V-2,94V-0
- ◆ COLOR : BLACK / NATURAL
- ◆ UNIT: mm

用途: 电线固定座,配线固定座用于固定电线。

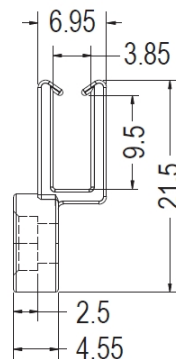
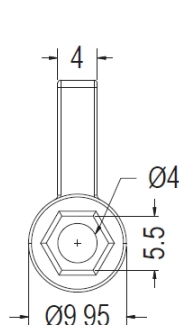

PART NO	PACKAGE
WS-T252	500

电线固定座

电线固定座 FLAT CABLE CLAMP 配线固定座



- ◆ MATERIAL : NYLON 66(UL)
- ◆ FLAME CLASS : 94V-2,94V-0
- ◆ COLOR : BLACK / NATURAL
- ◆ UNIT: mm

用途： 电线固定座,配线固定座将电线固定于LCD-TV上，电线不易磨损，配线整齐美观。

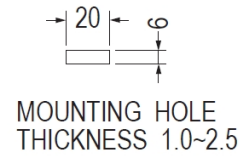
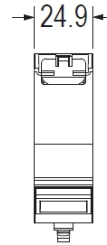
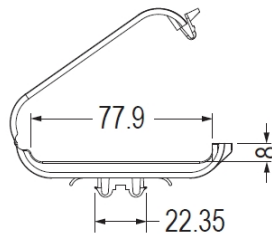

PART NO	PACKAGE
WS-T127	500

电线固定座 WIRE SADDLE 配线固定座



- ◆ MATERIAL : PP(UL)
- ◆ FLAME CLASS : 94HB
- ◆ COLOR : BLACK/COMPUTER/NATURAL
- ◆ UNIT: mm

用途： 电线固定座,配线固定座将电线固定于LCD-TV上，电线不易磨损，配线整齐美观。

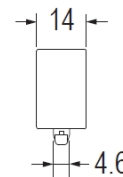
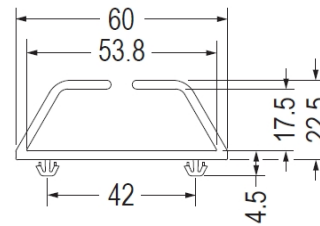

CHASSIS Ø4.8 THICKNESS 1.5

PART NO	PACKAGE
DH-60	100

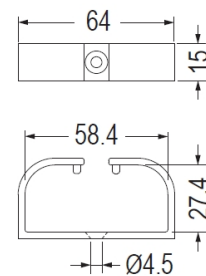
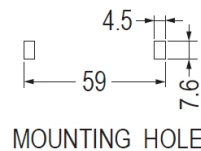
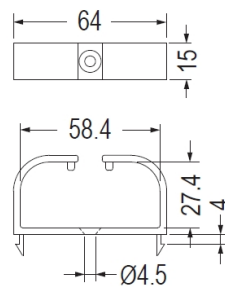

PART NO	PACKAGE
DH-61	100

PART NO	PACKAGE
DH-62	100

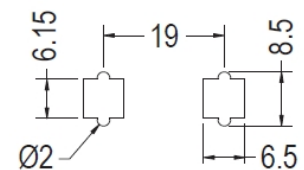
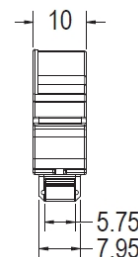
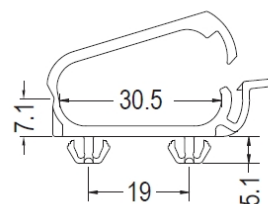

MOUNTING HOLE THICKNESS 0.8~1.2

PART NO	PACKAGE
WS-T752	100

电线固定座 WIRE MOUNT 配线固定座



- ◆ MATERIAL : PP (UL)
- ◆ FLAME CLASS : 94HB
- ◆ COLOR : NATURAL
- ◆ UNIT: mm

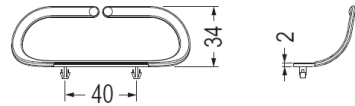
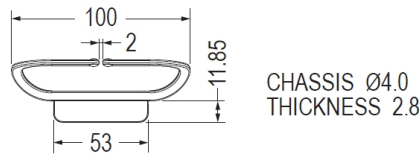

PART NO	PACKAGE
DH-63	100

用途：电线固定座,配线固定座将电线固定于LCD-TV上, 电线不易磨损, 配线整齐美观。

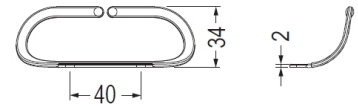
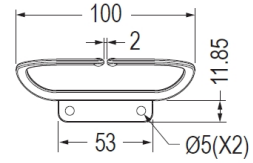

PART NO	PACKAGE
DH-64	100

电线固定座 WIRE SADDLE 配线固定座

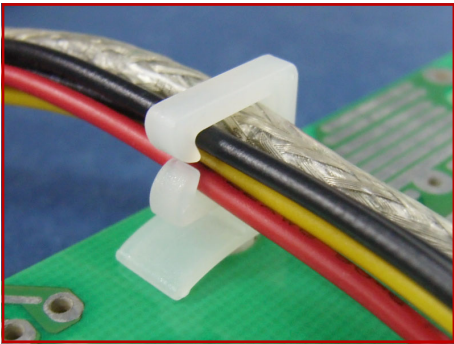

- ◆ MATERIAL : NYLON 66(UL)
- ◆ FLAME CLASS : 94V-2,94V-0
- ◆ COLOR : BLACK / NATURAL
- ◆ UNIT: mm

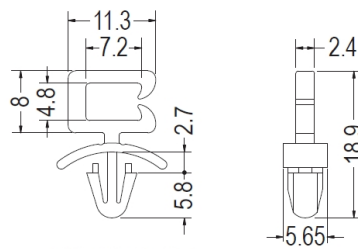

CHASSIS Ø4.8
THICKNESS 0.8~2.0

用途：电线固定座,配线固定座固定电线于PC板或机板上, 维修方便, 不占空间。

PART NO	PACKAGE
WS-T263	1000

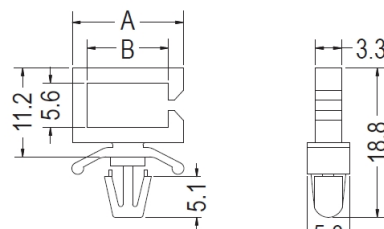
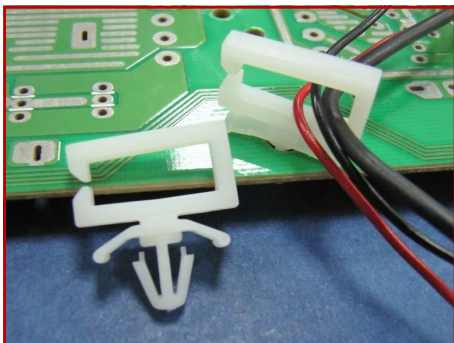

CHASSIS Ø4.8
THICKNESS 0.8~2.0

PART NO	D	E	PACKAGE
WS-T346	14.0	10.2	1000
WS-T347	17.0	13.2	1000

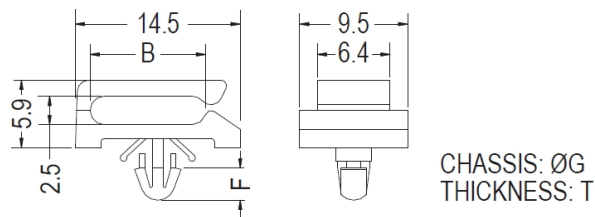
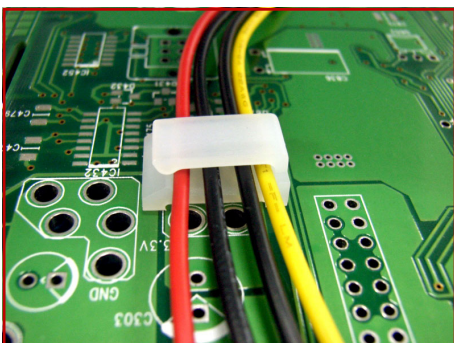

PART NO	B	F	G	T	PACKAGE
WS-T796	10.2	2.8	3.0	0.6~1.8	1000
WS-T804	10.15	3.15	4.0	1.6	1000

电线固定座 WIRE SADDLE 配线固定座

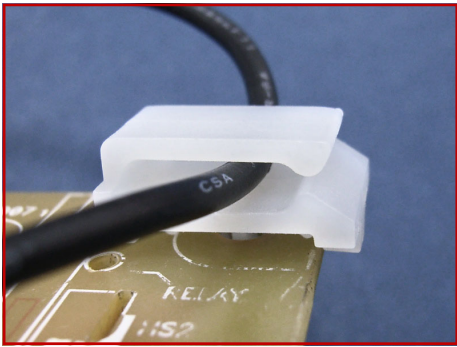

- ◆ MATERIAL : NYLON 66(UL)
- ◆ FLAME CLASS : 94V-2,94V-0
- ◆ COLOR : BLACK / NATURAL
- ◆ UNIT: mm

用途： 电线固定座,配线固定座固定电线于PC板或机板上，维修方便，不占空间。

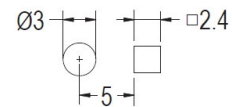
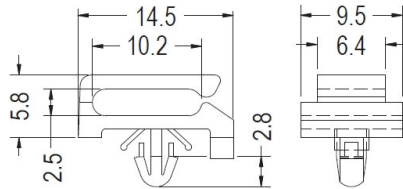

MOUNTING HOLE Ø3.0
THICKNESS: T

PART NO	T	PACKAGE
WS-T793	0.6~1.8	2000
WS-T794	1.0~2.2	2000

电线固定座

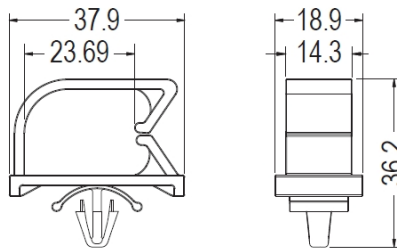
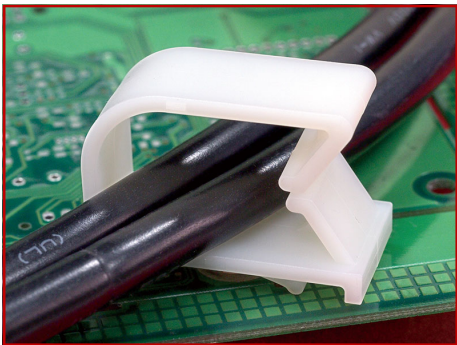

CHASSIS Ø6.4
THICKNESS 1.9

PART NO	PACKAGE
WS-T868	500

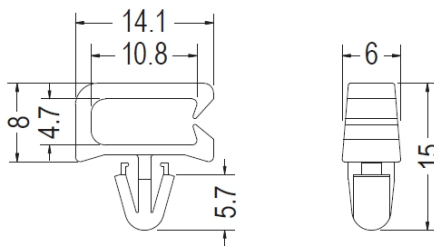
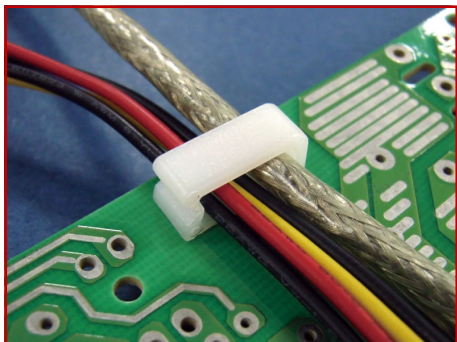

CHASSIS Ø4.8
THICKNESS 0.8~1.6

PART NO	PACKAGE
WS-T797	2000

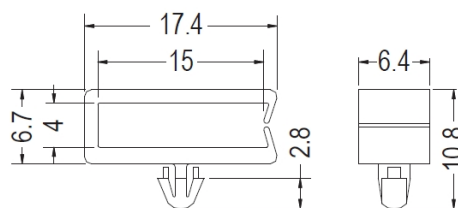
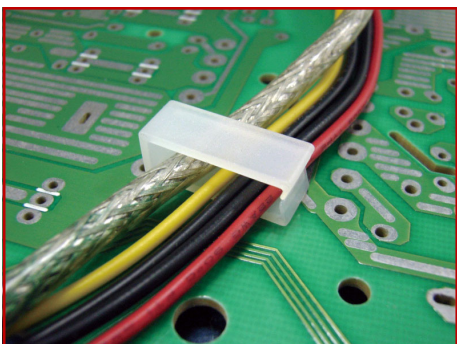

CHASSIS Ø3.0
THICKNESS 1.0

PART NO	PACKAGE
WS-T798	2000

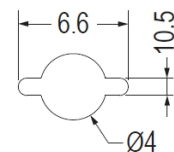
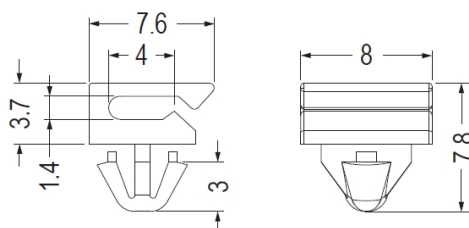

MOUNTING HOLE
THICKNESS 0.8

PART NO	PACKAGE
WS-T795	2000

电线固定座 WIRE SADDLE 配线固定座



- ◆ MATERIAL : NYLON 66(UL)
- ◆ FLAME CLASS : 94V-2,94V-0
- ◆ COLOR : BLACK / NATURAL
- ◆ UNIT: mm

用途： 电线固定座,配线固定座固定电线于PC板或机板上， 维修方便， 不占空间。

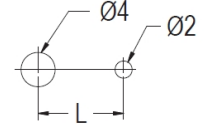
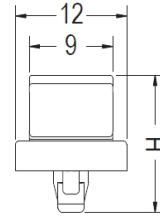
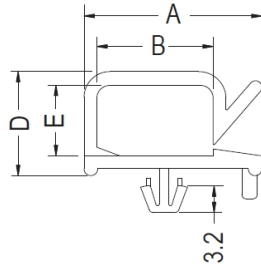

MOUNTING HOLE THICKNESS: T

PART NO	A	B	D	E	H	L	T	PACKAGE
WS-T800	20.8	13.6	12.5	8.2	16.9	10.0	0.6~0.8	500
WS-T801	16.8	10.5	10.3	6.5	14.3	7.0	0.8~1.0	500
WS-T802	16.8	10.5	10.3	6.5	14.8	7.0	1.2	500
WS-T803	16.8	10.5	10.3	6.5	15.2	7.0	1.6	500

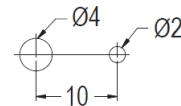
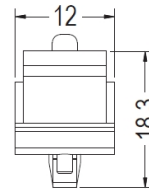
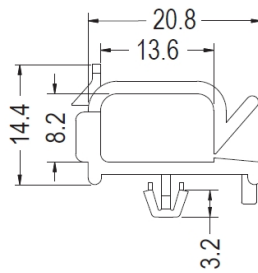

MOUNTING HOLE THICKNESS 0.6~1.0

PART NO	PACKAGE
WS-T792	1000

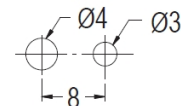
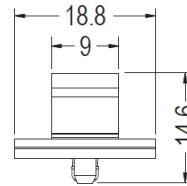
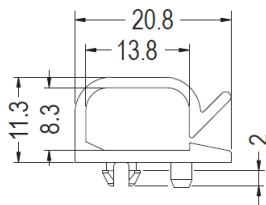
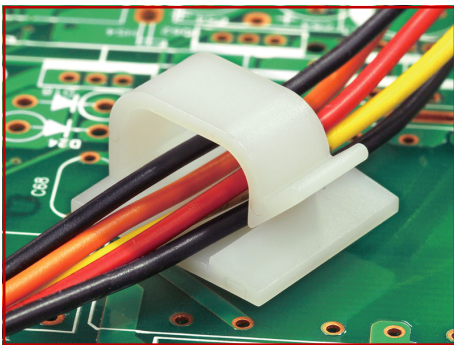

MOUNTING HOLE THICKNESS 1.0

PART NO	PACKAGE
WS-T863	1000

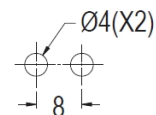
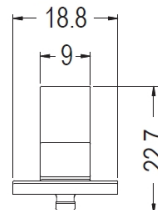
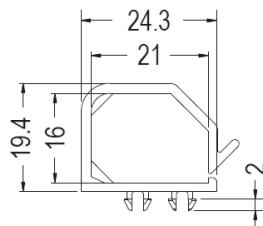

MOUNTING HOLE THICKNESS 1.0

PART NO	PACKAGE
WS-T877	1000

电线固定座 WIRE SADDLE 配线固定座

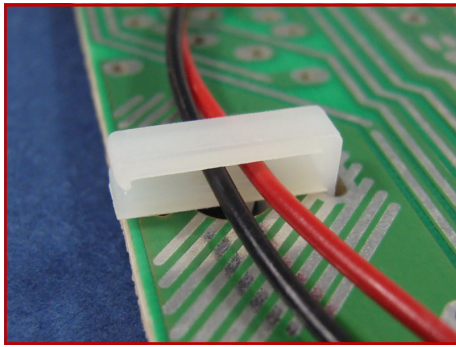

- ◆ MATERIAL : NYLON 66(UL)
- ◆ FLAME CLASS : 94V-2,94V-0
- ◆ COLOR : BLACK / NATURAL
- ◆ UNIT: mm

用途： 电线固定座,配线固定座固定电线于PC板或机板上，维修方便，不占空间。

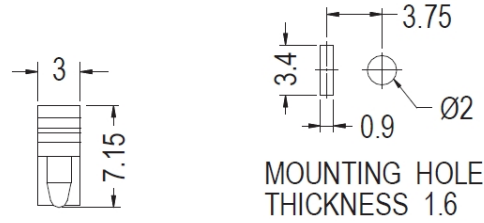
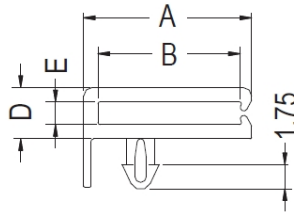

PART NO	A	B	D	E	PACKAGE
WS-T773	11.8	10.0	3.6	1.6	1000
WS-T878	14.8	12.48	4.3	2.3	1000

电线固定座

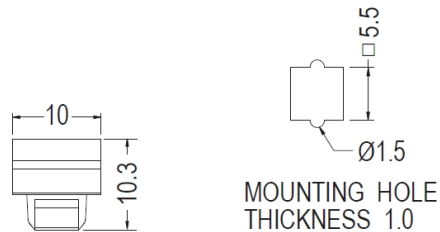
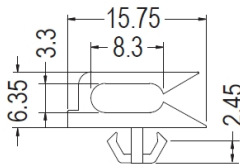
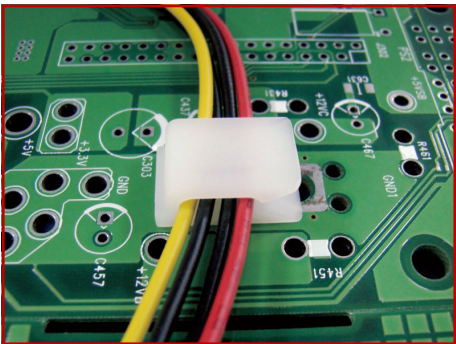

PART NO	PACKAGE
WS-T799	1000

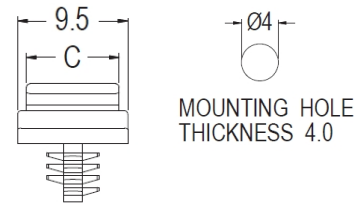
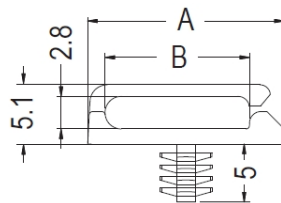
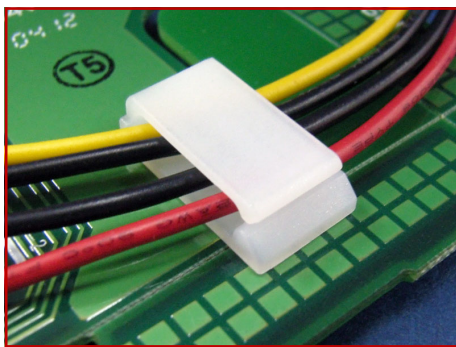

PART NO	B	F	G	PACKAGE
WS-T200	17.0	12.5	8.0	1000
WS-T870	12.7	8.3	6.4	1000

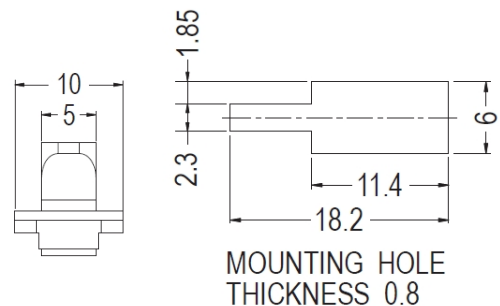
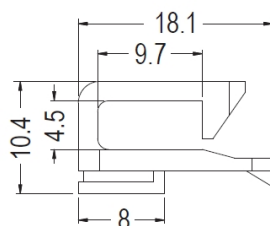
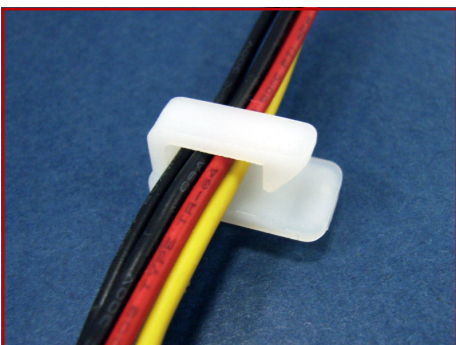

PART NO	PACKAGE
WS-T197	1000

电线固定座 WIRE SADDLE 配线固定座

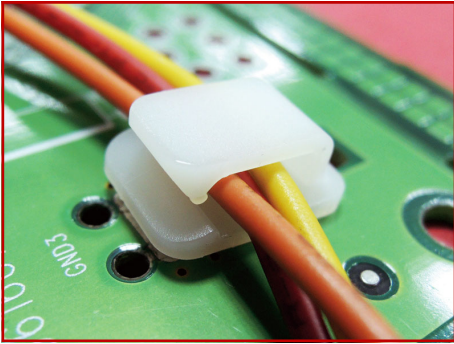

- ◆ MATERIAL : NYLON 66(UL)
- ◆ FLAME CLASS : 94V-2,94V-0
- ◆ COLOR : BLACK / NATURAL
- ◆ UNIT: mm

用途： 电线固定座,配线固定座，快速拆卸，固定电线于PC板或机板上，维修方便，不占空间。

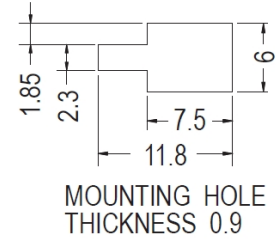
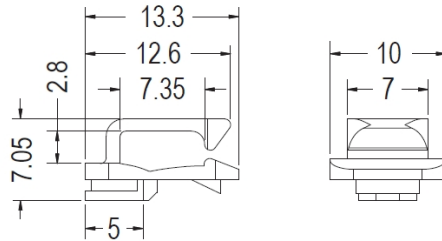

PART NO	PACKAGE
WS-T026	1000

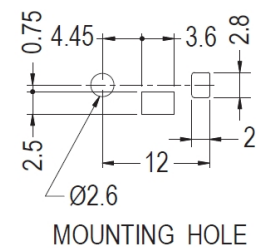
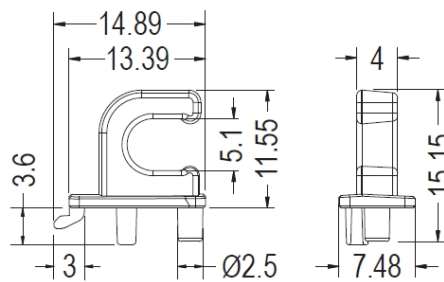
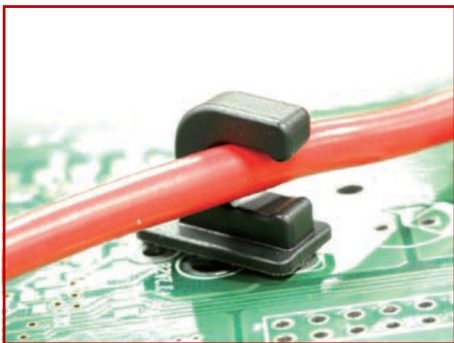

PART NO	PACKAGE
WS-T540	1000

电线固定座 FLAT CABLE CLAMP 配线固定座



- ◆ MATERIAL : NYLON 66(UL)
- ◆ FLAME CLASS : 94V-2,94V-0
- ◆ COLOR : BLACK / NATURAL
- ◆ UNIT: mm

用途： 电线固定座,配线固定座，可快速固定电线，安装容易。

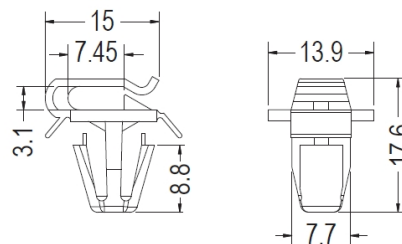

CHASSIS Ø8.0
THICKNESS 1.0~2.8

PART NO	PACKAGE
WS-T833	1000

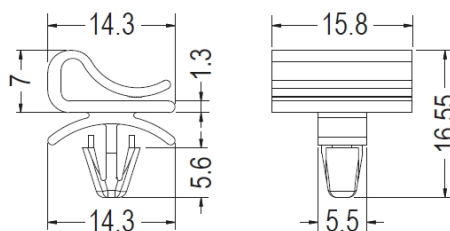
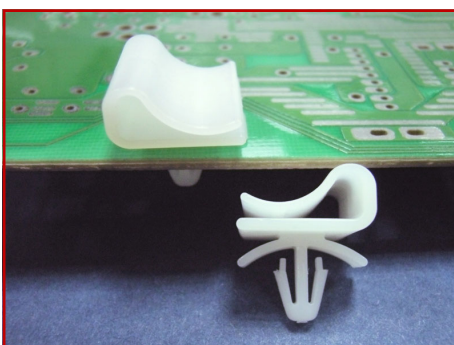

CHASSIS Ø4.8
THICKNESS 0.6~2.0

PART NO	PACKAGE
WS-T139	1000

电线固定座 FLAT CABLE CLAMP 配线固定座

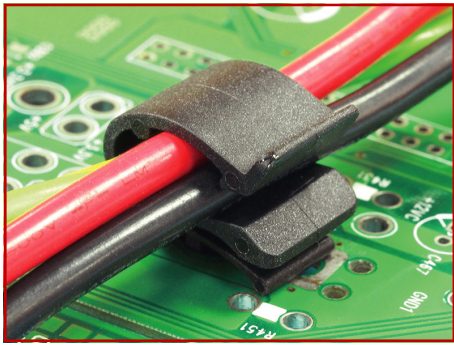

- ◆ MATERIAL : NYLON 66(UL)
- ◆ FLAME CLASS : 94V-2,94V-0
- ◆ COLOR : BLACK / NATURAL
- ◆ UNIT: mm

用途： 电线固定座,配线固定座可快速固定电线，安装容易。

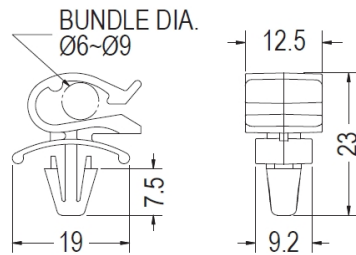

MOUNTING HOLE Ø6.3~Ø6.5
THICKNESS 1.0~3.0

PART NO	PACKAGE
WS-T542	1000

电线固定座

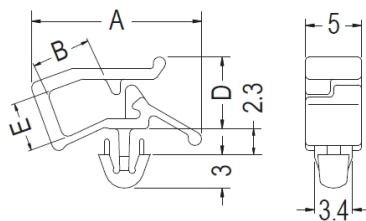
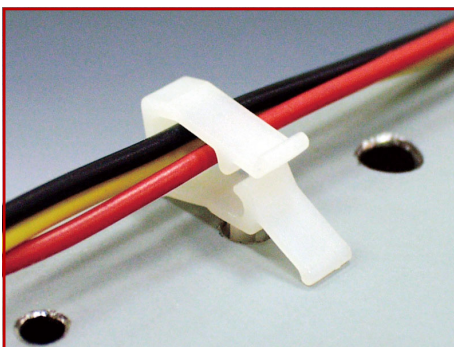

CHASSIS Ø3.5
THICKNESS 0.5~1.6

PART NO	A	B	D	E	PACKAGE
WS-T843	20.3	7.2	8.5	6.2	1000
WS-T844	15.2	5.3	6.4	4.3	1000
WS-T845	13.5	4.1	5.0	2.6	1000

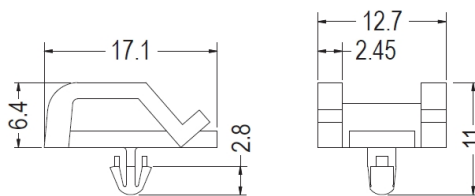

CHASSIS Ø3.0
THICKNESS 1.6

用途： 电线固定座,配线固定座固定电线于PC板或机板上，维修方便，不占空间。

PART NO	PACKAGE
WS-T443	1000

电线固定座 WIRE SADDLE 配线固定座

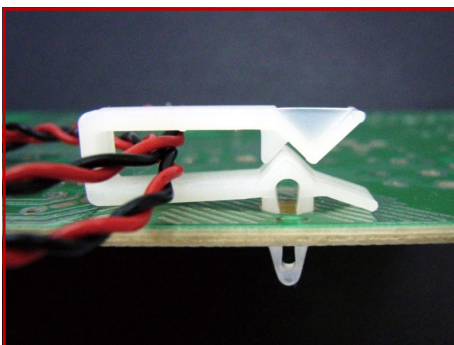

- ◆ MATERIAL : NYLON 66(UL)
- ◆ FLAME CLASS : 94V-2,94V-0
- ◆ COLOR : BLACK / NATURAL
- ◆ UNIT: mm

用途： 电线固定座,配线固定座用于电子、计算机内部排线固定，装配容易，美观不脱落，固定力强。

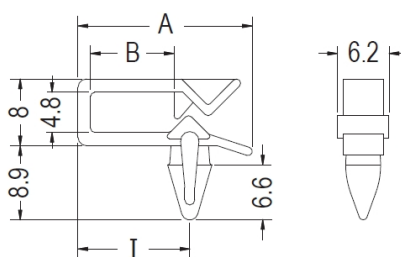

CHASSIS Ø4.8
THICKNESS 2.0

PART NO	A	B	I	PACKAGE
WS-T840	20.9	10.0	13.4	1000
WS-T841	24.2	13.2	16.8	1000
WS-T842	17.5	6.6	10.8	1000

电线固定座 WIRE SADDLE 配线固定座

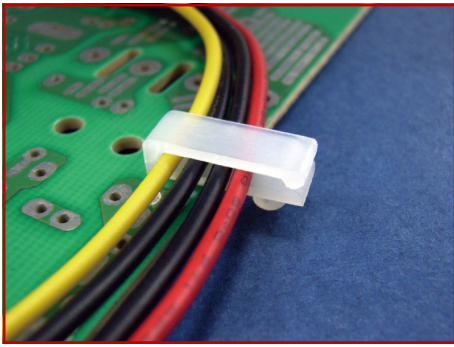

- ◆ MATERIAL : NYLON 66(UL)
- ◆ FLAME CLASS : 94V-2,94V-0
- ◆ COLOR : BLACK / NATURAL
- ◆ UNIT: mm

用途： 电线固定座,配线固定座，快速拆卸，固定电线于PC板或机板上，维修方便，不占空间。

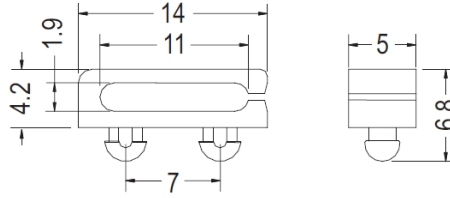

MOUNTING HOLE $\varnothing 3.0$
THICKNESS 0.8~1.0

PART NO	PACKAGE
DH-65	2000

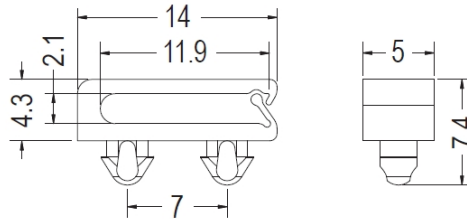
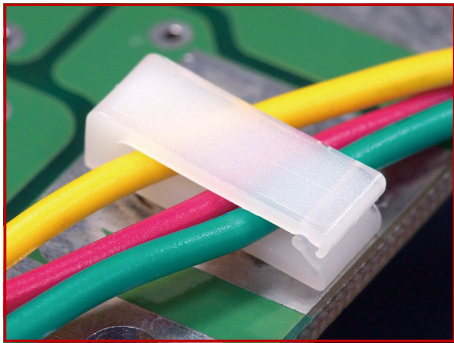

MOUNTING HOLE $\varnothing 3.0$
THICKNESS 0.8~1.0

PART NO	PACKAGE
WS-T560	1000

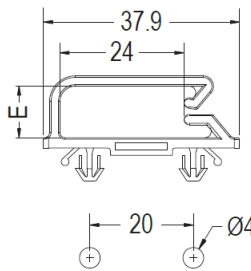
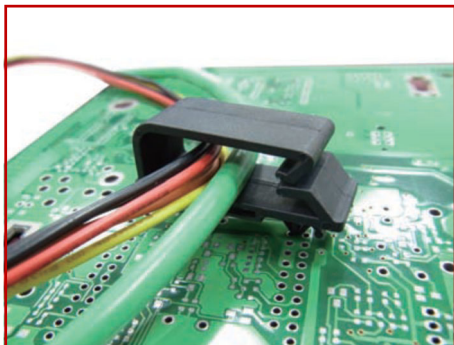

MOUNTING HOLE
THICKNESS 0.8~2.0

PART NO	E	PACKAGE
DH-66	18.7	200
DH-67	10.0	500

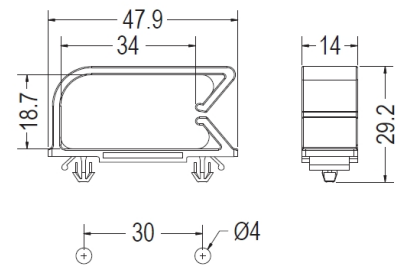

MOUNTING HOLE
THICKNESS 0.8~2.0

PART NO	PACKAGE
DH-68	1000

电线固定座 CABLE CLAMP 配线固定座



- ◆ MATERIAL : NYLON 66(UL)
- ◆ FLAME CLASS : 94V-2,94V-0
- ◆ COLOR : BLACK / NATURAL
- ◆ UNIT: mm

用途： 电线固定座,配线固定座,固定电线于木板或机壳上，维修方便，不占空间。

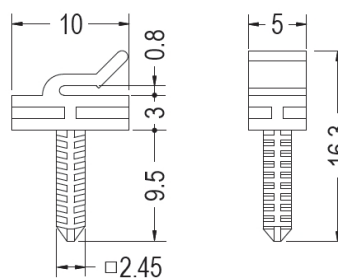

CHASSIS $\varnothing 3.0$

PART NO	PACKAGE
WS-T343	1000

电线固定座 CABLE CLAMP 配线固定座



- ◆ MATERIAL : NYLON 66(UL)
- ◆ FLAME CLASS : 94V-2,94V-0
- ◆ COLOR : BLACK / NATURAL
- ◆ UNIT: mm

用途： 电线固定座,配线固定座固定电线于PC板或机壳上，维修方便，不占空间。

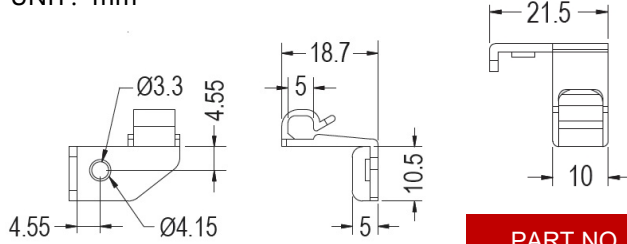

PART NO	PACKAGE
WS-T199	1000

电线固定座

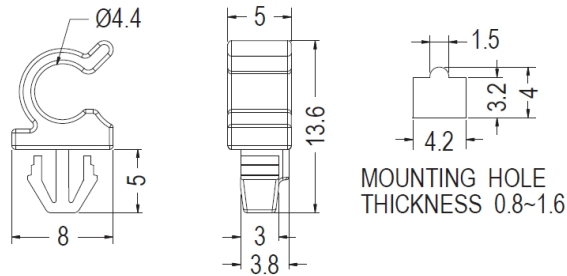
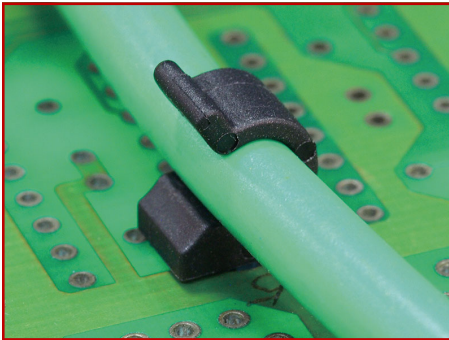

PART NO	PACKAGE
WS-T869	1000

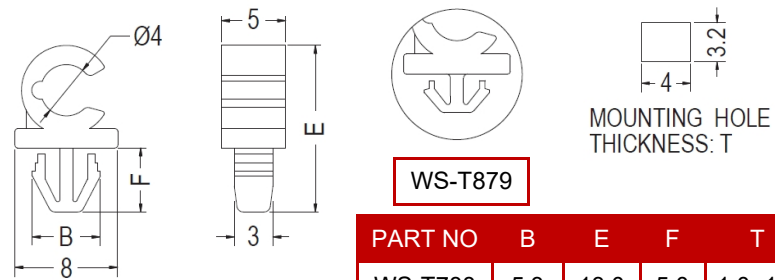
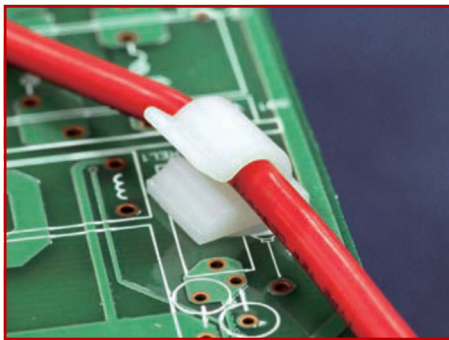

WS-T879

PART NO	B	E	F	T	PACKAGE
WS-T788	5.3	13.0	5.0	1.0~1.6	500
WS-T855	5.5	13.0	5.0	1.0~1.6	500
WS-T879	4.9	10.9	2.9	1.0	500

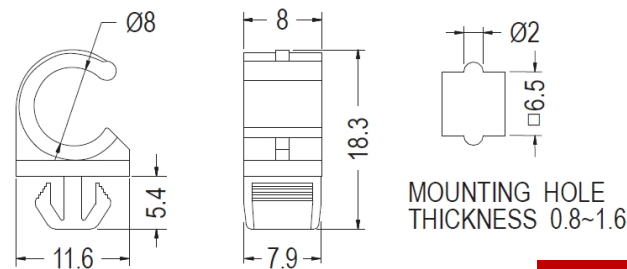
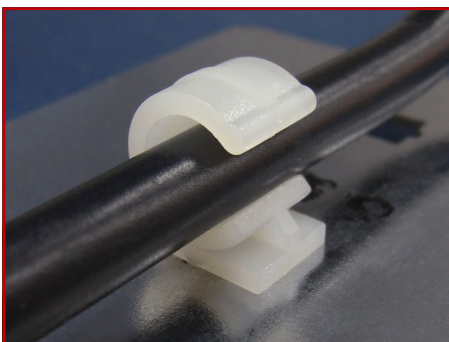

PART NO	PACKAGE
WS-T781	1000

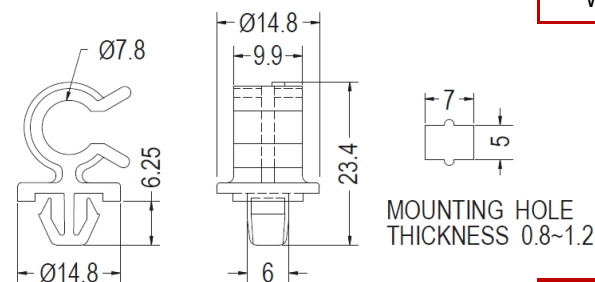

PART NO	PACKAGE
WS-T780	1000

电线固定座 WIRE SADDLE 配线固定座

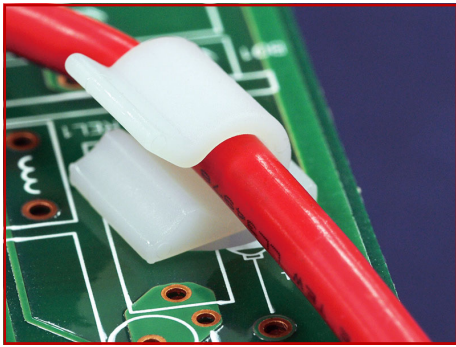

- ◆ MATERIAL : NYLON 66(UL)
- ◆ FLAME CLASS : 94V-2,94V-0
- ◆ COLOR : BLACK / NATURAL
- ◆ UNIT: mm

用途： 电线固定座,配线固定座，快速拆卸，固定电线于PC板或机板上，维修方便，不占空间。

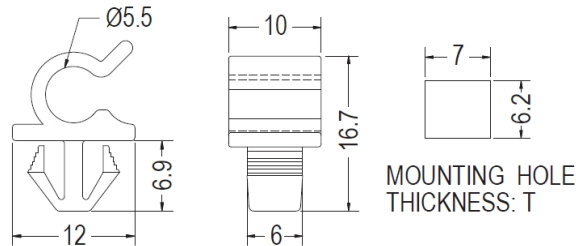

PART NO	T	PACKAGE
WS-T864	2.0	1000
WS-T880	0.7~2.0	1000

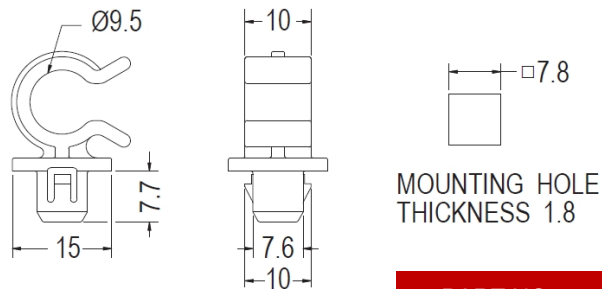

PART NO	PACKAGE
WS-T576	1000

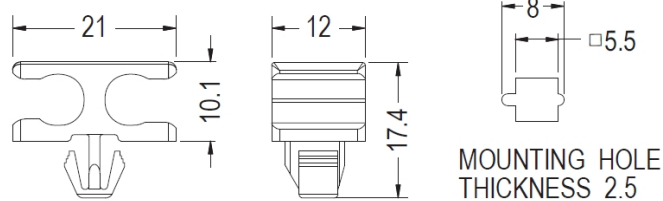
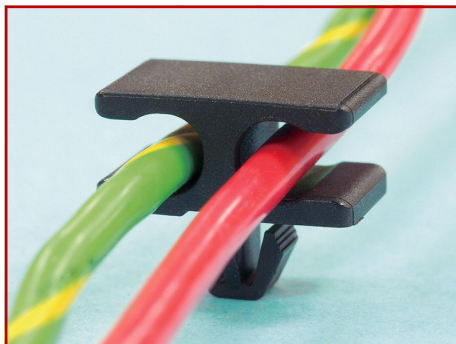

PART NO	PACKAGE
WS-T775	1000

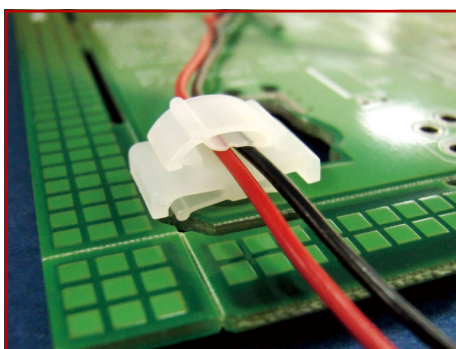

- ◆ MATERIAL : NYLON 66(UL)
- ◆ FLAME CLASS : 94V-2,94V-0
- ◆ COLOR : BLACK / NATURAL
- ◆ UNIT: mm

用途： 电线固定座,配线固定座，用于 Ø3.5板孔，可快速固定及解开电线。

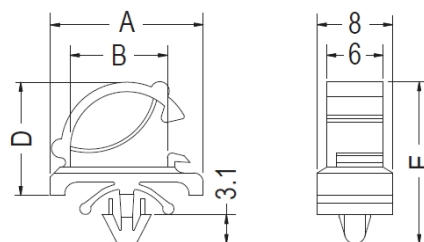

CHASSIS Ø3.5
THICKNESS: T

PART NO	A	B	D	E	T	PACKAGE
WS-T332	13.5	6.2	8.2	14.0	0.8~2.0	1000
WS-T333	13.5	6.2	8.6	14.6	0.8~2.5	1000
WS-T334	16.2	10.3	12.0	17.6	0.8~2.0	1000
WS-T335	16.2	10.3	12.0	18.0	0.8~2.5	1000

电线固定座 CABLE CLAMP 配线固定座

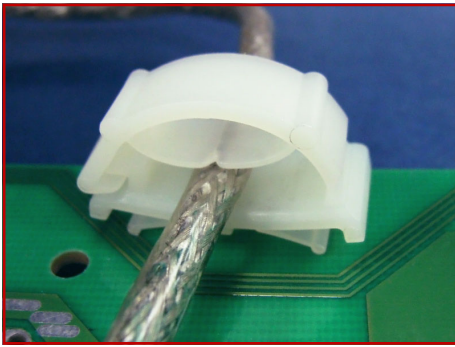

- ◆ MATERIAL : NYLON 66(UL)
- ◆ FLAME CLASS : 94V-2,94V-0
- ◆ COLOR : BLACK / NATURAL
- ◆ UNIT: mm

用途： 电线固定座,配线固定座可快速固定及解开电线。

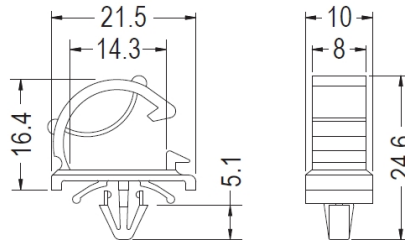

CHASSIS Ø4.8
THICKNESS 0.8~2.5

PART NO	PACKAGE
WS-T336	500

电线固定座



- ◆ MATERIAL : NYLON 66(UL)
- ◆ FLAME CLASS : 94V-2,94V-0
- ◆ COLOR : BLACK / NATURAL
- ◆ UNIT: mm

用途： 电线固定座,配线固定座,固定电线于PC板或机板上, 维修方便, 不占空间。

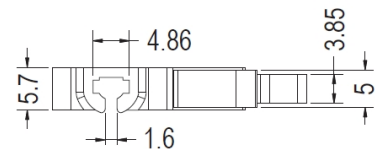
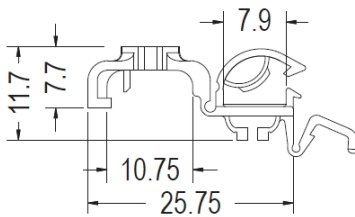

PART NO	PACKAGE
WS-T421	1000

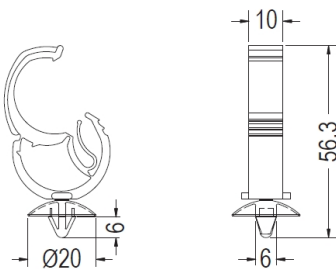

CHASSIS Ø6.2-Ø6.7
THICKNESS 0.5-2.0

PART NO	PACKAGE
WS-T516	1000

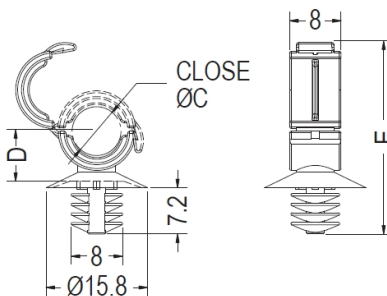
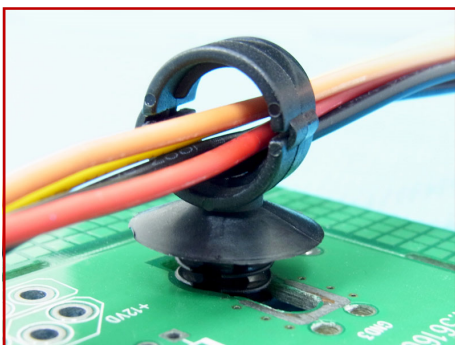

MOUNTING HOLE Ø6.5-Ø7.0
THICKNESS 0.8-9.0

PART NO	C	D	E	PACKAGE
WS-T041	5.5	6.3	24.4	1000
WS-T042	8.0	7.7	29.8	1000

电线固定座 WIRE SADDLE 配线固定座

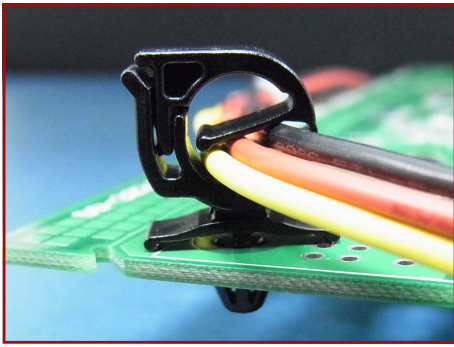

- ◆ MATERIAL : NYLON 66(UL)
- ◆ FLAME CLASS : 94V-2,94V-0
- ◆ COLOR : BLACK / NATURAL
- ◆ UNIT: mm

用途： 电线固定座,配线固定座，快速拆卸，固定电线于PC板或机板上，维修方便，不占空间。

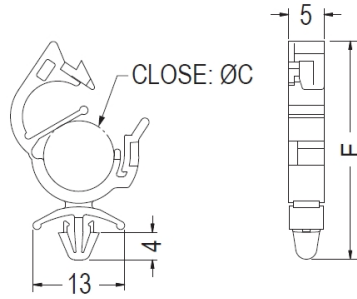

CHASSIS Ø4.0
THICKNESS 0.8~1.6

PART NO	C	E	PACKAGE
WS-T075	7.6	26.7	500
WS-T076	10.0	31.0	500
WS-T077	12.0	34.4	500

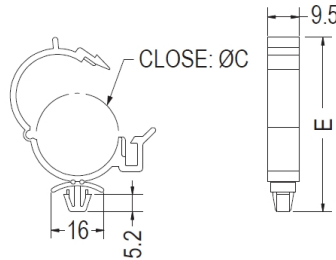
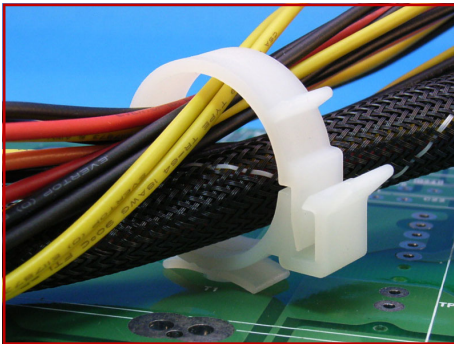

CHASSIS Ø6.5
THICKNESS: T

PART NO	C	E	T	PACKAGE
WS-T181	25.0	52.8	0.8~1.6	100
WS-T182	30.0	29.7	0.8~2.0	100

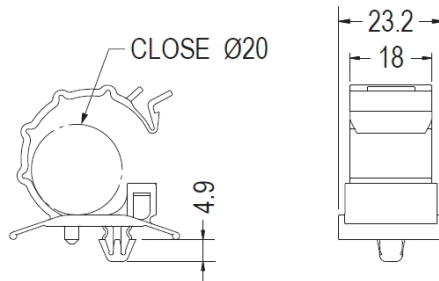
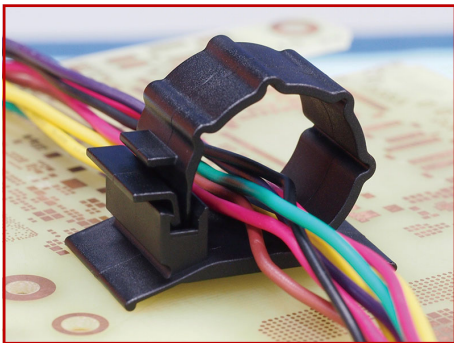

MOUNTING HOLE
THICKNESS 0.8~1.5

PART NO	PACKAGE
WS-T578	1000

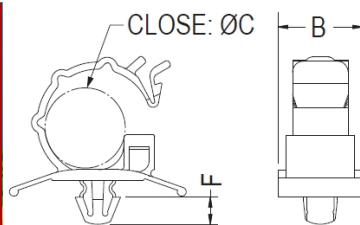
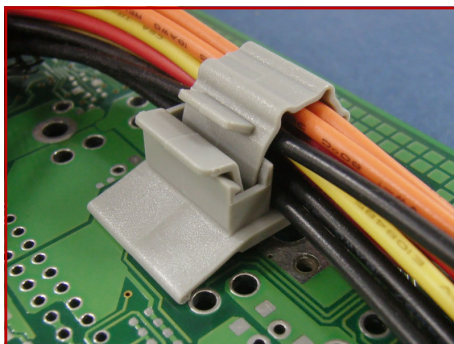

CHASSIS Ø6.4
THICKNESS: T

PART NO	A	B	D	T	PACKAGE
WS-T096	15.0	7.0	4.9	0.8~2.3	200
WS-T097	17.2	10.3	4.9	0.8~2.3	200
WS-T098	19.2	13.0	4.9	0.5~2.3	200
WS-T099	19.3	14.8	4.9	0.8~2.3	200
WS-T100	21.3	16.0	4.9	0.5~2.3	200
WS-T101	23.2	20.0	4.9	0.5~2.3	200
WS-T102	23.2	20.0	4.9	2.3~4.1	200
WS-T663	31.4	28.0	5.0	0.5~2.3	200

- ◆ MATERIAL : NYLON 66(UL)
- ◆ FLAME CLASS : 94V-2,94V-0
- ◆ COLOR : BLACK / NATURAL/GRAY
- ◆ UNIT: mm

电线固定座 CABLE CLAMP 配线固定座

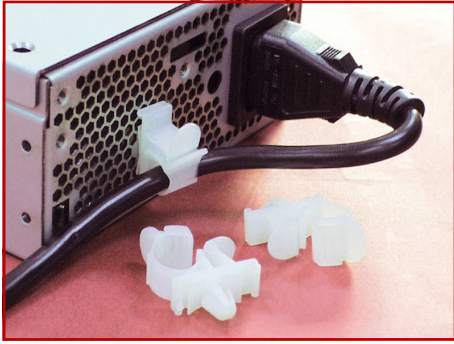

- ◆ MATERIAL : NYLON 66(UL)
- ◆ FLAME CLASS : 94V-2,94V-0
- ◆ COLOR : BLACK / NATURAL
- ◆ UNIT: mm

用途： 电线固定座,配线固定座可固定电源线，避免不小心脱落，造成计算机停机。

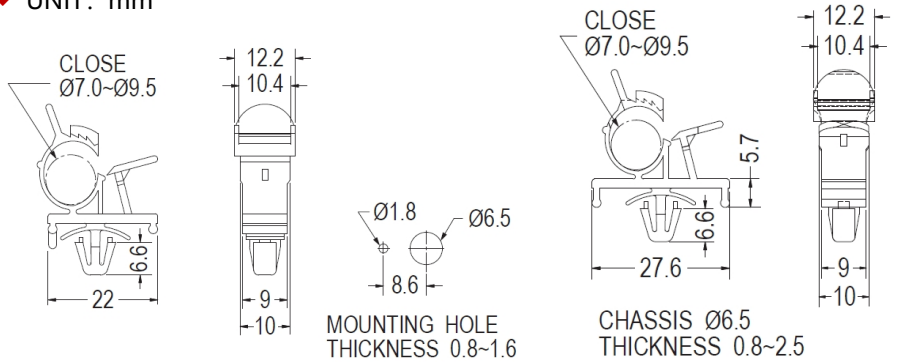

PART NO	PACKAGE
WS-T027	2000

PART NO	PACKAGE
WS-T028	1000

电线固定座

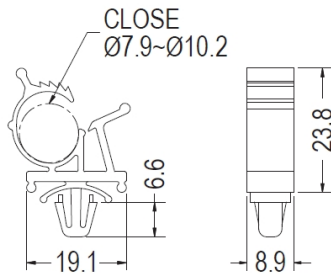
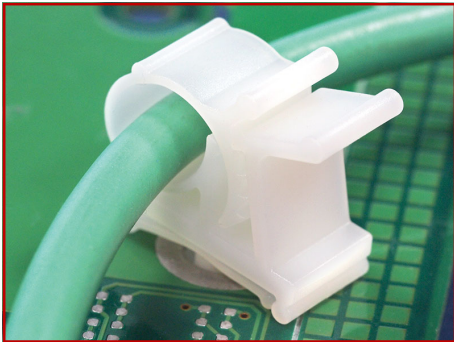

MOUNTING HOLE $\varnothing 6.35$
THICKNESS 0.8~1.5

PART NO	PACKAGE
WS-T559	500

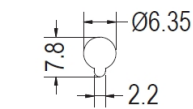
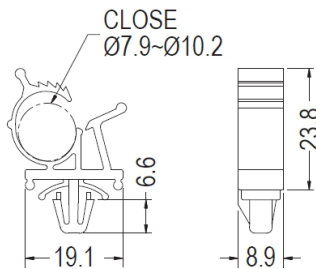

MOUNTING HOLE
THICKNESS 0.8~1.5

PART NO	PACKAGE
WS-T705	500

电线固定座 WIRE SADDLE 配线固定座



- ◆ MATERIAL : NYLON 66(UL)
- ◆ FLAME CLASS : 94V-2,94V-0
- ◆ COLOR : BLACK / NATURAL/GRAY
- ◆ UNIT: mm

用途： 电线固定座,配线固定座，快速拆卸，固定电线于PC板或机板上，维修方便，不占空间。

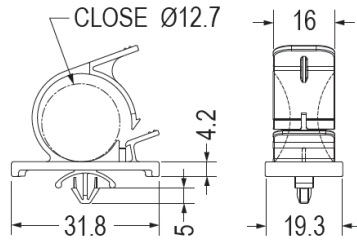

MOUNTING HOLE $\varnothing 5.0\sim\varnothing 6.0$
THICKNESS 0.6~2.7

PART NO	PACKAGE
WS-T422	1000

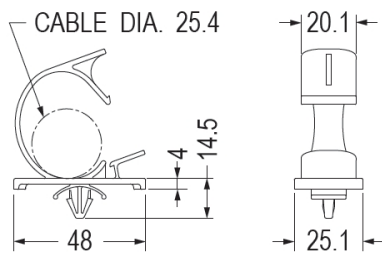
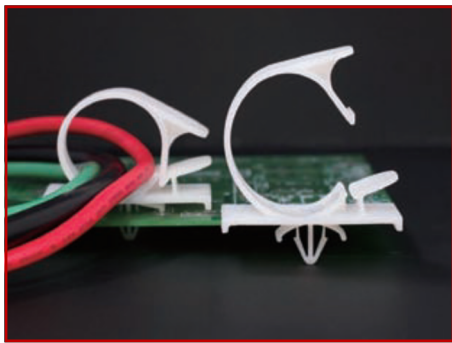

MOUNTING HOLE $\varnothing 5.0\sim\varnothing 6.0$
THICKNESS 0.6~2.7

PART NO	PACKAGE
WS-T706	1000

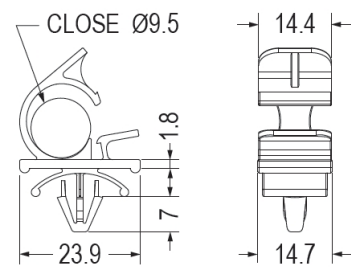
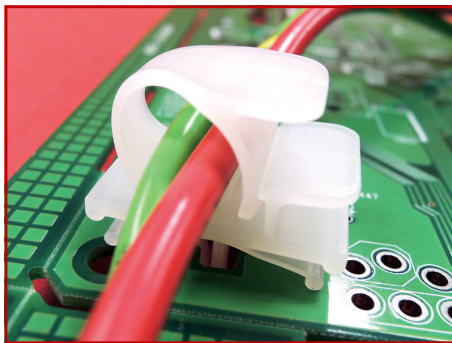

MOUNTING HOLE $\varnothing 6.5\sim\varnothing 7.0$
THICKNESS 0.6~2.7

PART NO	PACKAGE
WS-T517	250

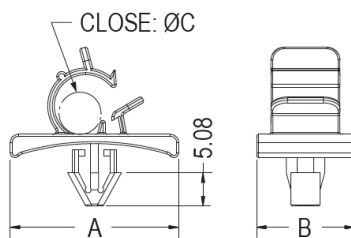

CHASSIS $\varnothing 6.35$
THICKNESS: T

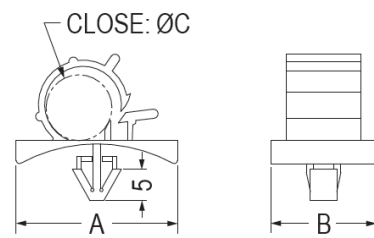

CHASSIS $\varnothing 6.5$
THICKNESS: T

WS-T312

PART NO	A	B	C	T	PACKAGE
WS-T312	25.7	16.8	10.5	0.8~1.6	500
WS-T313	35.05	22.35	19.05	0.5~2.0	100
WS-T314	25.4	14.73	6.35	2.3~3.8	500
WS-T315	25.4	16.51	9.52	2.3~3.8	500

电线固定座

电线固定座 WIRE SADDLE 配线固定座

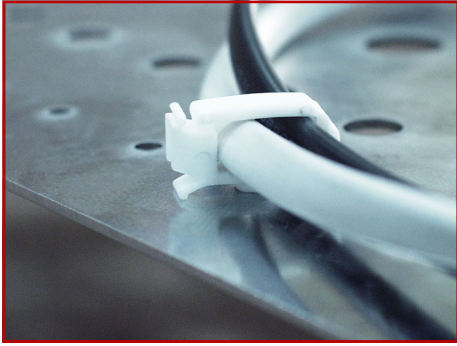

- ◆ MATERIAL : NYLON 66(UL)
- ◆ FLAME CLASS : 94V-2,94V-0
- ◆ COLOR : BLACK / NATURAL
- ◆ UNIT: mm

用途： 电线固定座,配线固定座固定电线于PC板或机板上， 维修方便， 不占空间。

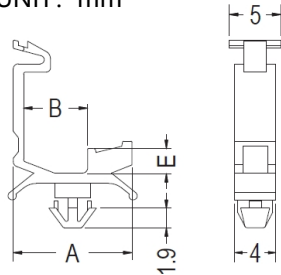

CHASSIS Ø3.5
THICKNESS: T

PART NO	A	B	C	T	PACKAGE
WS-T764	11.5	6.2	2.4	0.8~2.2	1000
WS-T765	16.5	11.0	4.5	0.5~1.8	1000

电线固定座

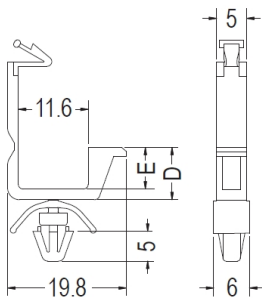
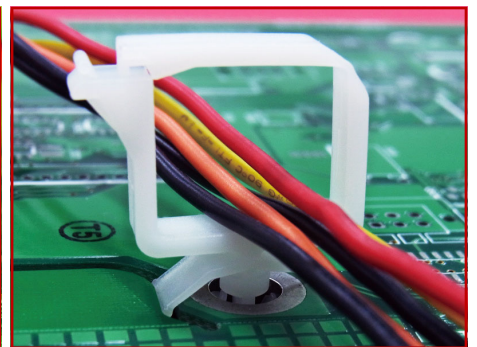
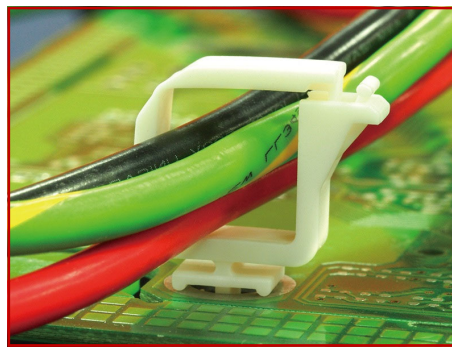
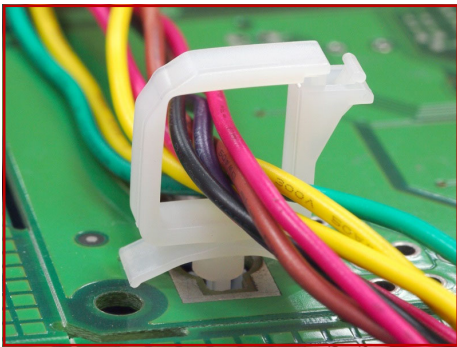

CHASSIS Ø4.8
THICKNESS 0.8~3.5

PART NO	E	D	PACKAGE
WS-T767	5.2	7.0	1000
WS-T768	12.4	14.2	500
WS-T856	7.0	8.8	1000

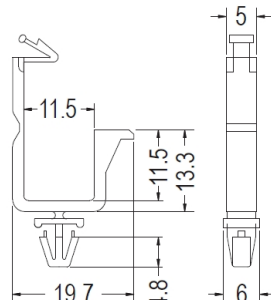

CHASSIS Ø4.8
THICKNESS 1.6

PART NO	PACKAGE
WS-T769	500

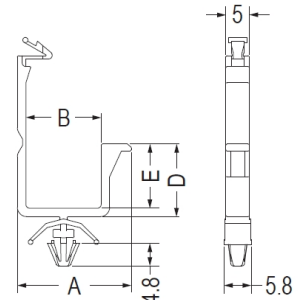

CHASSIS Ø4.8
THICKNESS 2.0~3.0

PART NO	A	B	E	D	PACKAGE
WS-T857	24.2	16.0	13.7	15.5	500
WS-T858	26.7	18.5	22.3	24.1	500

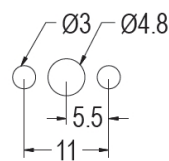
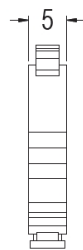
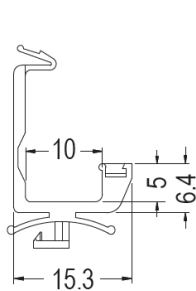
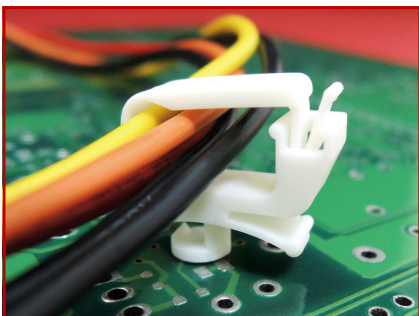

MOUNTING HOLE
THICKNESS 0.5~1.6

PART NO	PACKAGE
WS-T444	500

电线固定座 WIRE SADDLE 配线固定座

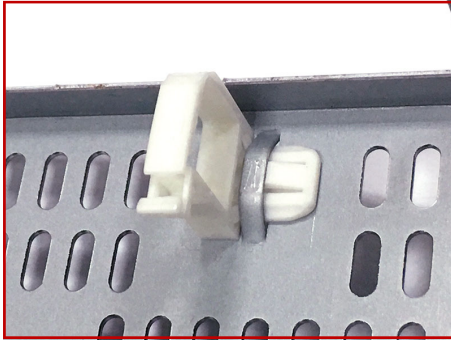

- ◆ MATERIAL : NYLON 66(UL)
 - ◆ FLAME CLASS : 94V-2,94V-0
 - ◆ COLOR : BLACK / NATURAL/GRAY
 - ◆ UNIT: mm
- 用途： 电线固定座,配线固定座, 用于固定电线, 整齐美观。

PART NO	A	B	C	PACKAGE
WS-T029	11.7	12.65	17.7	500
WS-T445	11.62	6.95	12.0	500

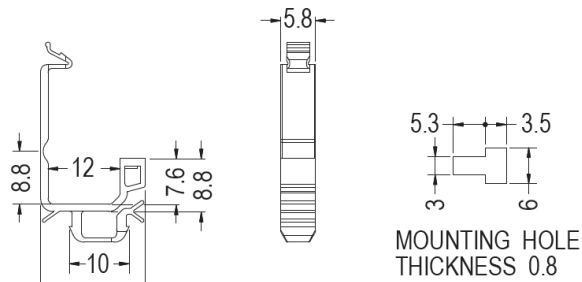
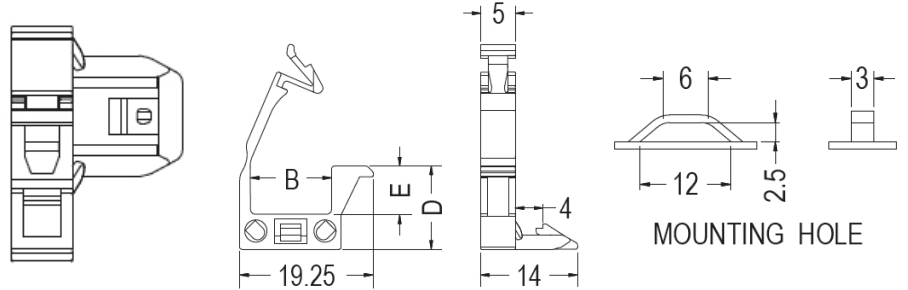

PART NO	PACKAGE
WS-T086	500

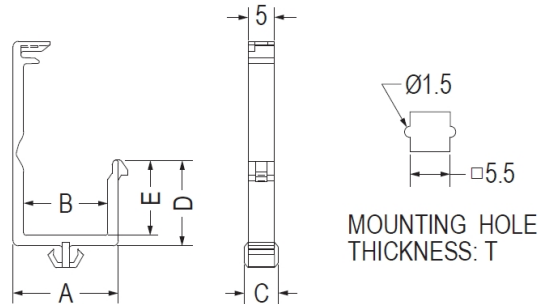
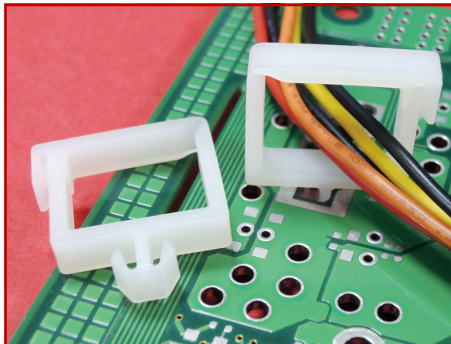

PART NO	A	B	C	D	E	T	PACKAGE
WS-T754	20.0	16.0	6.8	16.3	14.3	1.0	1000
WS-T755	15.1	11.1	6.8	12.5	10.5	1.0	1000
WS-T756	15.1	11.1	6.8	7.3	5.3	1.0	1000
WS-T859	20.0	16.0	6.7	16.3	14.3	2.0	1000
WS-T881	15.1	11.1	6.5	7.3	5.3	1.0	1000

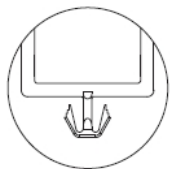

WS-T859

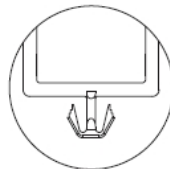

WS-T881

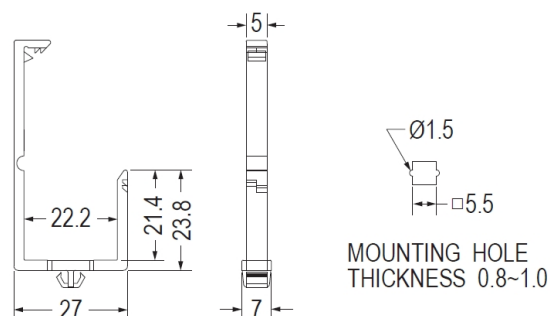
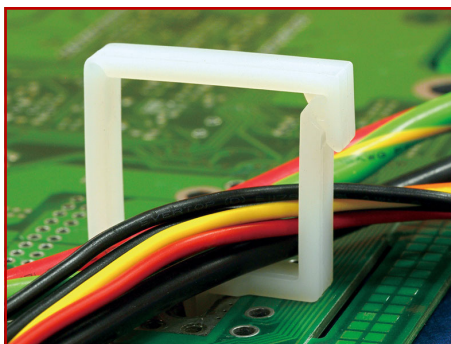

PART NO	PACKAGE
WS-T865	500

电线固定座

电线固定座 WIRE SADDLE 配线固定座

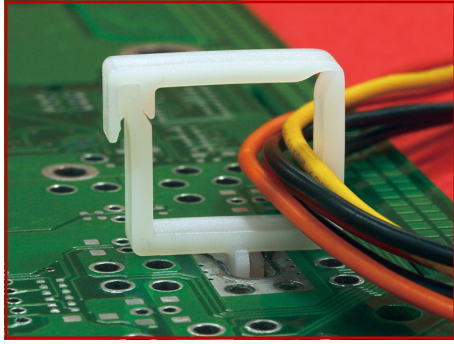

- ◆ MATERIAL : NYLON 66(UL)
- ◆ FLAME CLASS : 94V-2,94V-0
- ◆ COLOR : BLACK / NATURAL
- ◆ UNIT: mm

用途： 电线固定座,配线固定座固定电线于PC板或机板上，维修方便，不占空间。

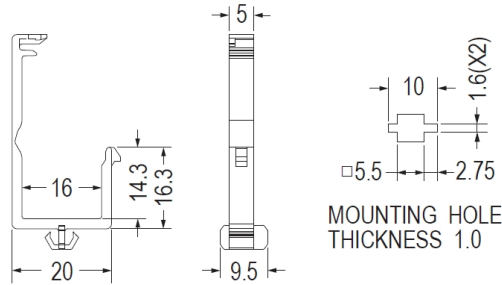

PART NO	PACKAGE
WS-T819	1000

电线固定座

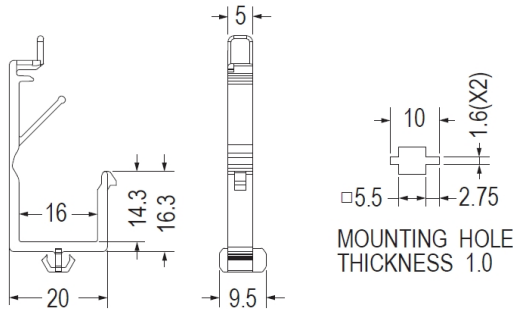
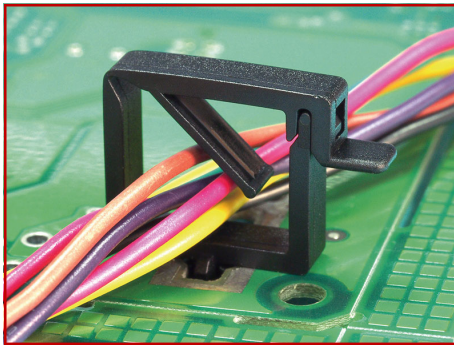

PART NO	PACKAGE
WS-T820	1000

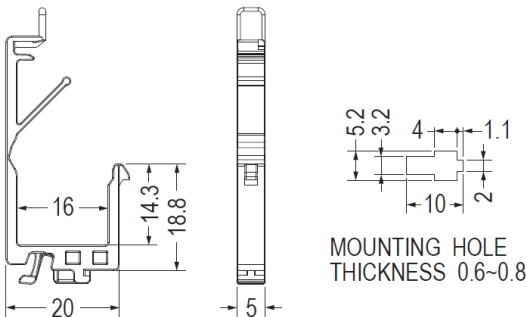
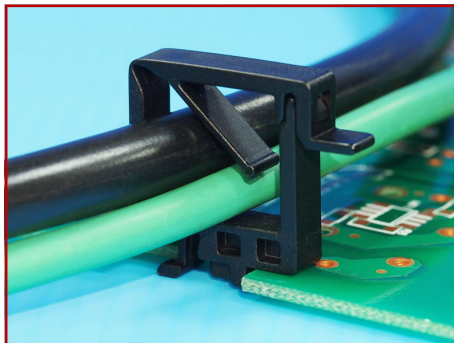

PART NO	PACKAGE
WS-T871	1000

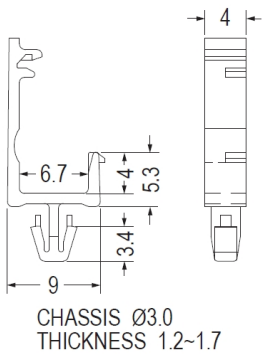
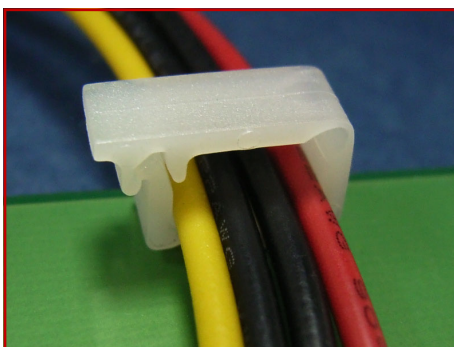

PART NO	PACKAGE
WS-T770	1000

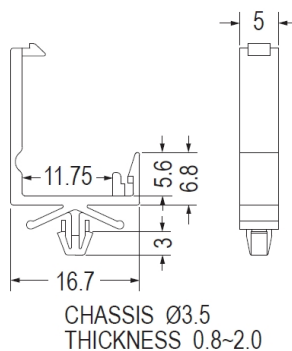
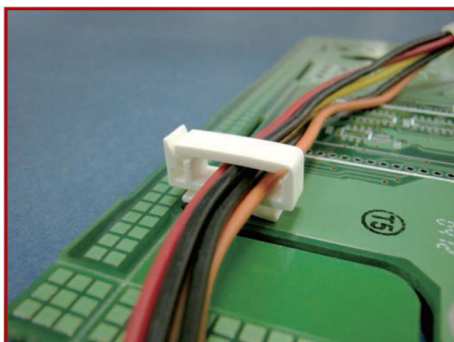

PART NO	PACKAGE
WS-T766	1000

电线固定座 WIRE SADDLE 配线固定座

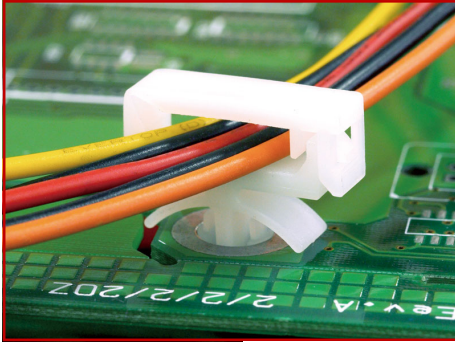

- ◆ MATERIAL : NYLON 66(UL)
- ◆ FLAME CLASS : 94V-2,94V-0
- ◆ COLOR : BLACK / NATURAL
- ◆ UNIT: mm

用途： 电线固定座,配线固定座固定电线于PC板或机板上，维修方便，不占空间。

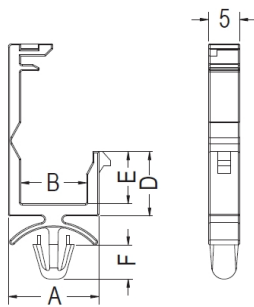

CHASSIS: ØG
THICKNESS: T

PART NO	A	B	D	E	F	G	T	PACKAGE
WS-T520	17.5	13.5	5.1	3.1	3.0	3.5	1.8	1000
WS-T521	17.5	13.5	5.1	3.1	5.6	4.8	2.0	1000
WS-T522	14.7	10.7	6.5	4.5	5.6	4.8	2.0	1000
WS-T523	14.7	10.7	10.5	8.5	5.6	4.8	2.0	500
WS-T524	20.3	16.3	11.7	9.7	5.6	4.8	2.0	500
WS-T525	20.3	16.3	15.8	13.8	5.6	4.8	2.0	500
WS-T526	22.0	18.0	23.4	21.4	5.6	4.8	2.0	500

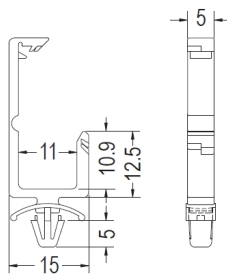
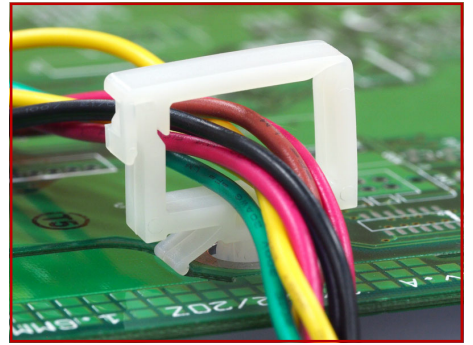
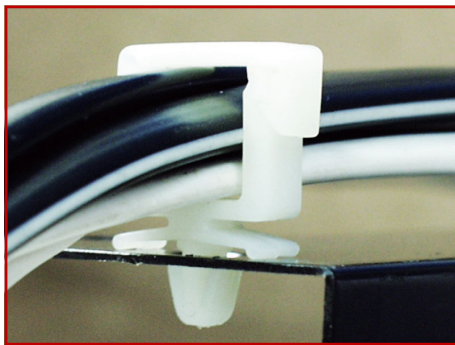

CHASSIS Ø4.8
THICKNESS 0.8-2.0

PART NO	PACKAGE
WS-T050	500

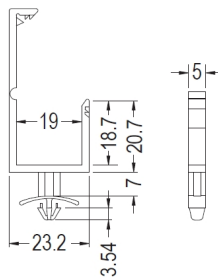

CHASSIS Ø4.8
THICKNESS 0.8-1.6

PART NO	PACKAGE
WS-T073	500

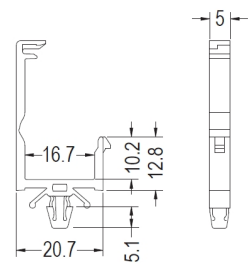

CHASSIS Ø4.8
THICKNESS 0.5-2.0

PART NO	PACKAGE
WS-T771	1000

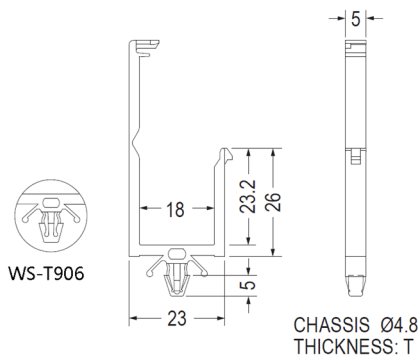
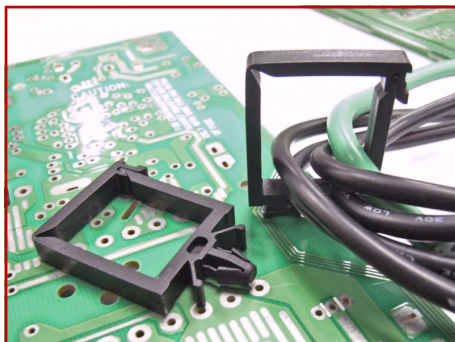

CHASSIS Ø4.8
THICKNESS: T

PART NO	T	PACKAGE
WS-T772	0.5~2.0	500
WS-T906	0.8~2.0	500

电线固定座 WIRE SADDLE 配线固定座

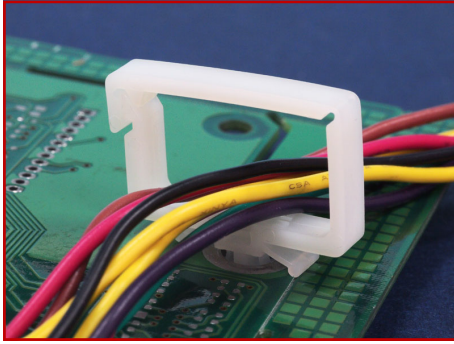

- ◆ MATERIAL : NYLON 66(UL)
- ◆ FLAME CLASS : 94V-2,94V-0
- ◆ COLOR : BLACK / NATURAL
- ◆ UNIT: mm

用途： 电线固定座,配线固定座固定电线于PC板或机板上，维修方便，不占空间。

PART NO	A	B	D	E	G	T	PACKAGE
WS-T759	20.25	16.0	15.9	14.0	4.8~5.0	1.2~2.4	500
WS-T760	15.35	11.1	11.8	9.9	4.8~5.0	1.2~2.4	500
WS-T761	15.35	11.1	6.8	4.9	4.8~5.0	1.2~2.4	500
WS-T860	27.0	22.8	14.85	12.85	4.8	0.5~1.0	500

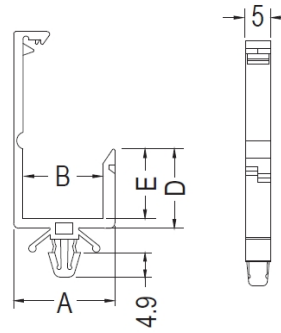

CHASSIS: ØG
THICKNESS: T

电线固定座

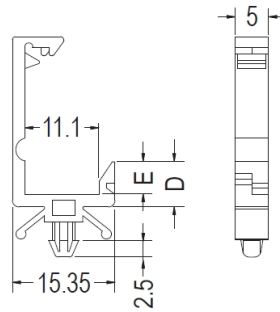
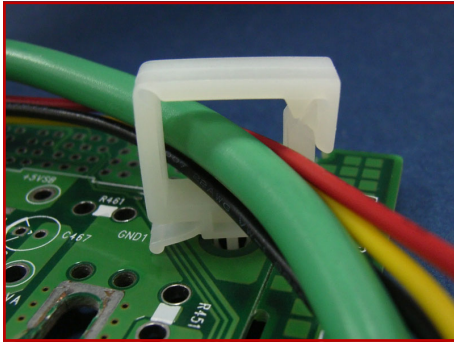

CHASSIS Ø3.5
THICKNESS 0.8-2.5

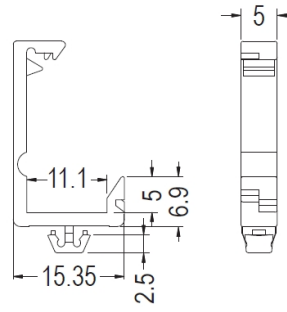

CHASSIS Ø4.8
THICKNESS 1.0

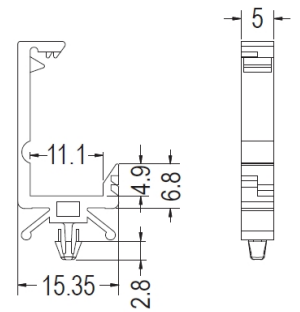

CHASSIS Ø3.0
THICKNESS 0.8-2.5

PART NO	E	D	PACKAGE
WS-T757	6.8	4.9	500
WS-T758	11.8	9.9	5000

PART NO	PACKAGE
WS-T762	500

PART NO	PACKAGE
WS-T763	500

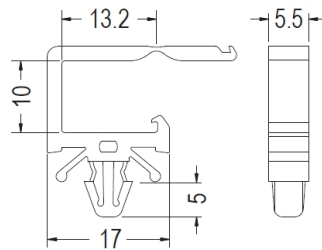
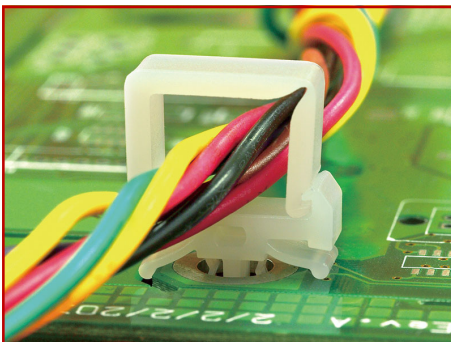

MOUNTING HOLE Ø4.8-Ø5.0
THICKNESS 1.2-2.4

PART NO	PACKAGE
WS-T546	1000

电线固定座 WIRE SADDLE 配线固定座

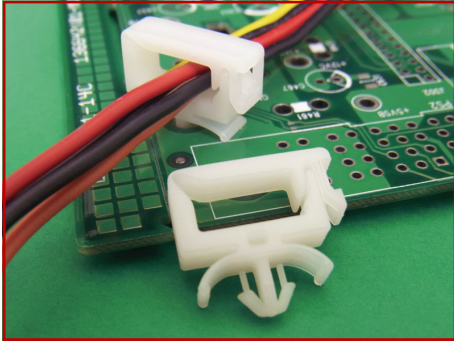

- ◆ MATERIAL : NYLON 66(UL)
- ◆ FLAME CLASS : 94V-2,94V-0
- ◆ COLOR : BLACK / NATURAL
- ◆ UNIT: mm

用途： 电线固定座,配线固定座固定电线于PC板或机板上， 维修方便， 不占空间。

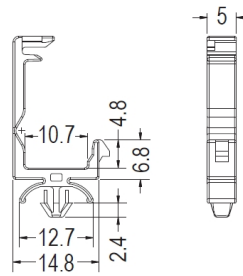

CHASSIS Ø4.0
THICKNESS 0.8-2.5

PART NO	PACKAGE
WS-T095	500

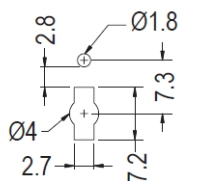
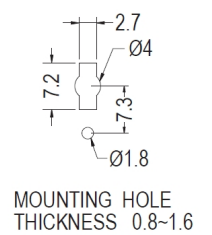
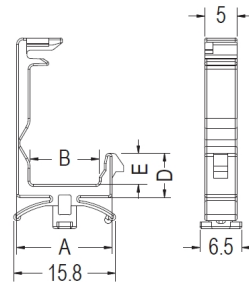
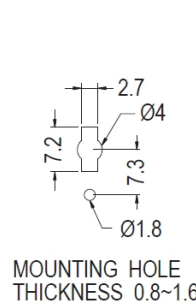
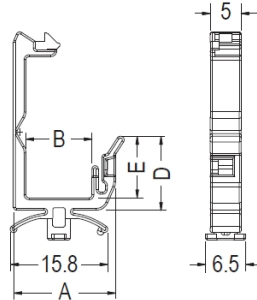
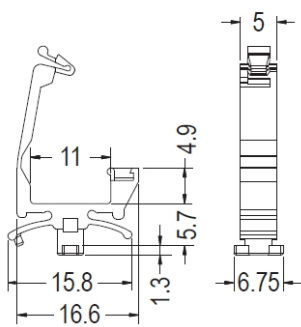
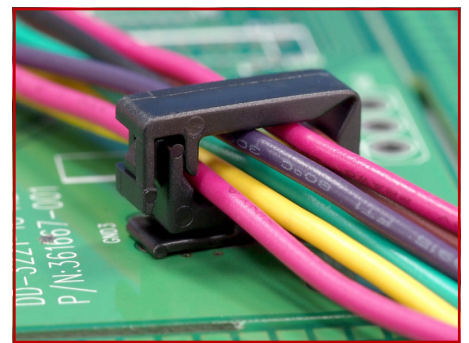
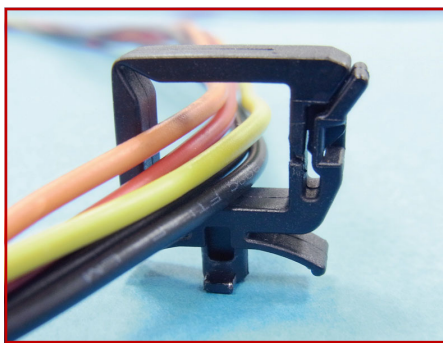
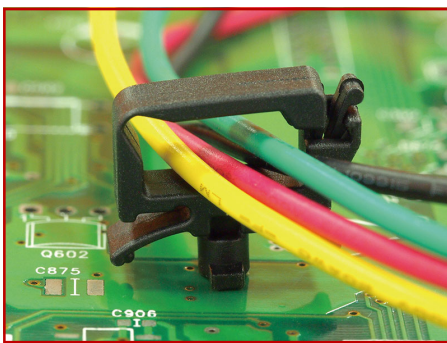

MOUNTING HOLE THICKNESS 0.8~2.0

PART NO	A	B	D	E	PACKAGE
WS-T093	16.5	10.7	11.95	9.95	500
WS-T094	22.1	16.3	12.85	10.85	500
WS-T451	22.1	16.3	16.95	14.95	500
WS-T452	23.8	18.0	24.55	22.55	500

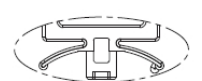
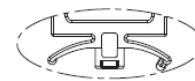

WS-T455~457

WS-T669~717

PART NO	PACKAGE
WS-T547	1000

PART NO	A	B	D	E	PACKAGE
WS-T453	14.8	10.7	6.8	4.8	1000
WS-T454	14.8	10.7	11.0	9.0	1000
WS-T455	20.4	16.3	11.9	9.9	500
WS-T456	20.4	16.3	16.0	14.0	500
WS-T457	22.1	18.0	23.6	21.6	500
WS-T669	14.8	10.7	6.8	4.8	1000
WS-T714	14.8	10.7	11.0	9.0	1000
WS-T715	20.4	16.3	11.9	9.9	500
WS-T716	20.4	16.3	16.0	14.0	500
WS-T717	22.1	18.0	23.6	21.6	500

电线固定座

电线固定座 WIRE SADDLE 配线固定座

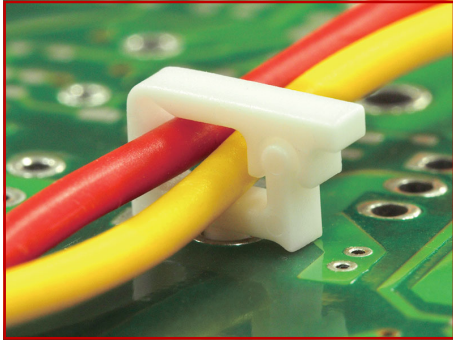

- ◆ MATERIAL : NYLON 66(UL)
- ◆ FLAME CLASS : 94V-2,94V-0
- ◆ COLOR : BLACK / NATURAL
- ◆ UNIT: mm

用途： 电线固定座,配线固定座固定电线于PC板或机板上，维修方便，不占空间。

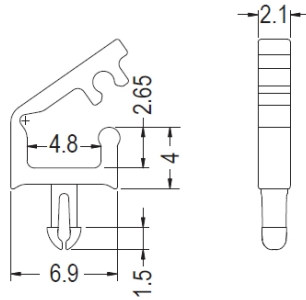

MOUNTING HOLE $\varnothing 1.7$
THICKNESS 2.4

PART NO PACKAGE

WS-T519	1000
---------	------

电线固定座

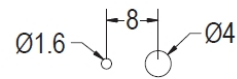
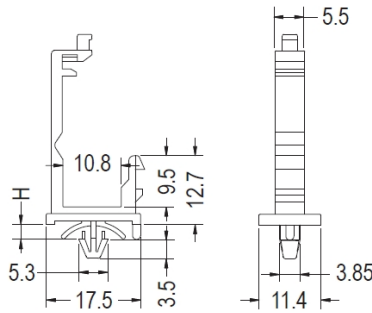
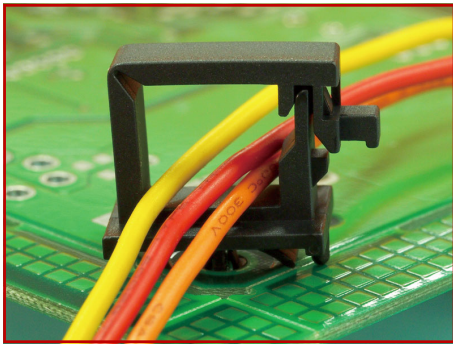

MOUNTING HOLE THICKNESS: T

PART NO H T PACKAGE

WS-T776	2.79	1.6~2.0	1000
---------	------	---------	------

WS-T866	1.70	0.8~1.0	1000
---------	------	---------	------

WS-T867	2.0	0.8~1.0	1000
---------	-----	---------	------

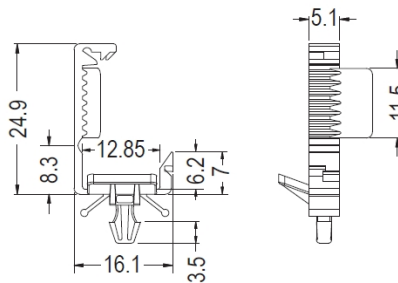
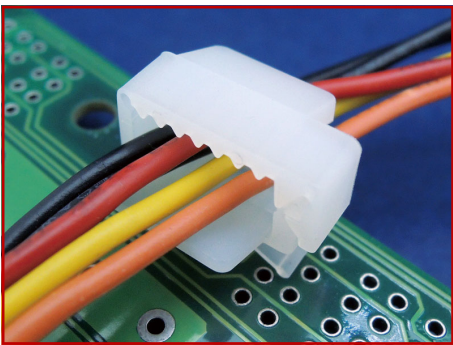

MOUNTING HOLE $\varnothing 3.5$
THICKNESS 1.0~2.5

PART NO PACKAGE

WS-T458	500
---------	-----

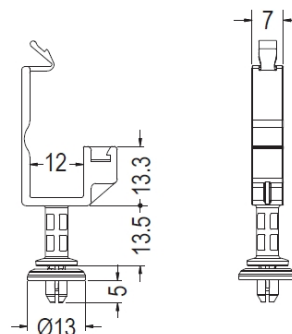
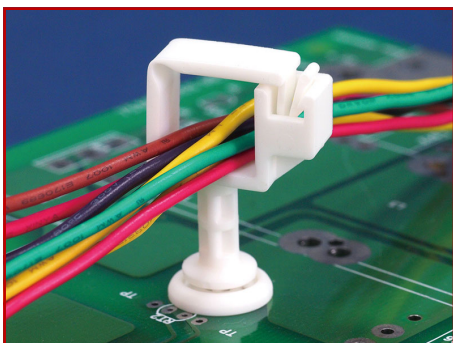

MOUNTING HOLE $\varnothing 4.6$
THICKNESS 3.5

PART NO PACKAGE

WS-T577	1000
---------	------

电线固定座 WIRE SADDLE 配线固定座

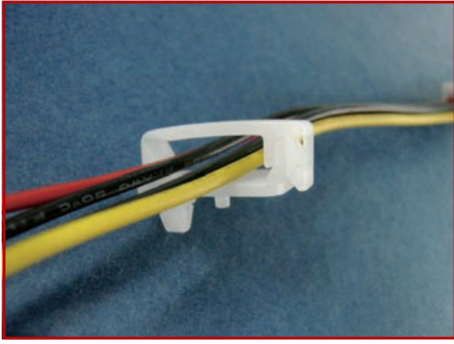

- ◆ MATERIAL : NYLON 66(UL)
- ◆ FLAME CLASS : 94V-2,94V-0
- ◆ COLOR : BLACK / NATURAL
- ◆ UNIT: mm

用途： 电线固定座,配线固定座固定电线于PC板或机板上，维修方便，不占空间。

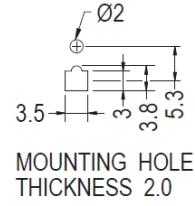
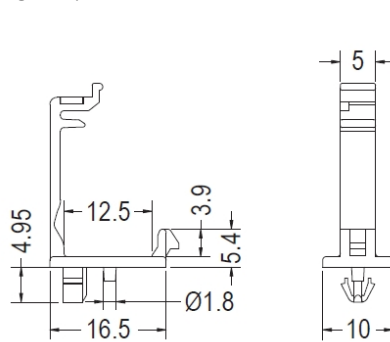

PART NO	PACKAGE
WS-T074	1000

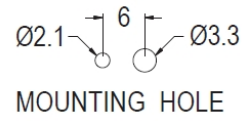
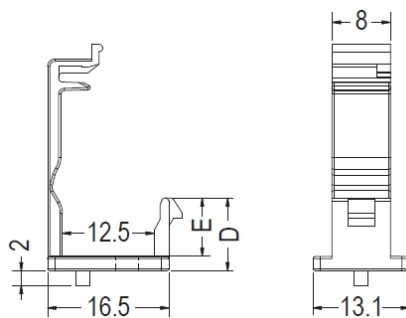
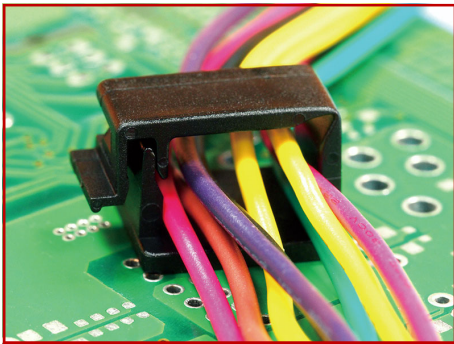

PART NO	D	E	PACKAGE
WS-T551	9.9	7.9	1000
WS-T670	13.0	11.0	1000

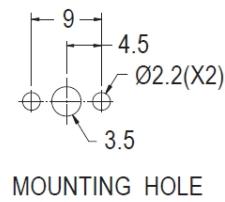
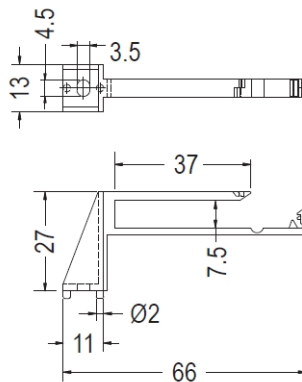
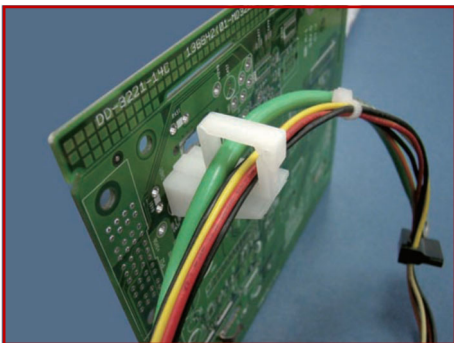

PART NO	PACKAGE
WS-T790	250

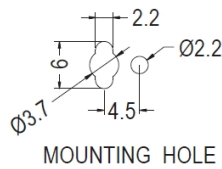
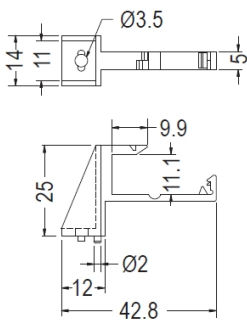

PART NO	PACKAGE
WS-T789	250

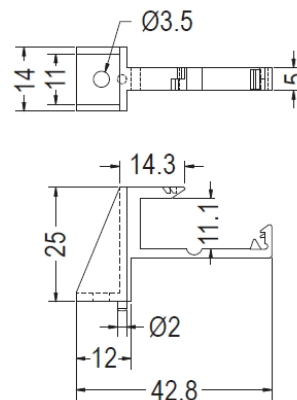

PART NO	PACKAGE
WS-T791	250

电线束线座 WIRE HODLER 配线固定座

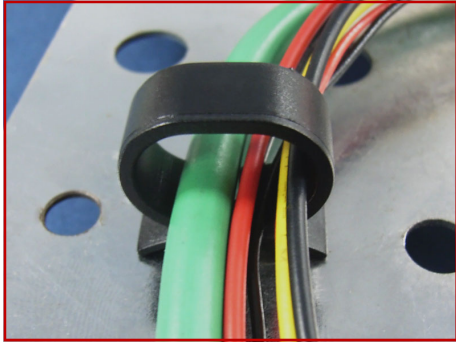

- ◆ MATERIAL : NYLON 66(UL)
- ◆ FLAME CLASS : 94V-2,94V-0
- ◆ COLOR : BLACK / NATURAL
- ◆ UNIT: mm

用途： 电线固定座,配线固定座固定电线于PC板或机板上， 维修方便， 不占空间。

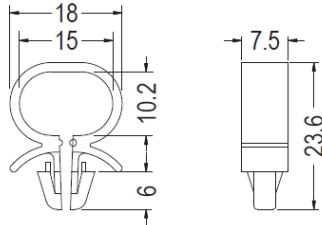

CHASSIS $\varnothing 6.0\text{--}\varnothing 6.5$
THICKNESS 0.8~2.5

PART NO	PACKAGE
DH-31	500

电线束线座

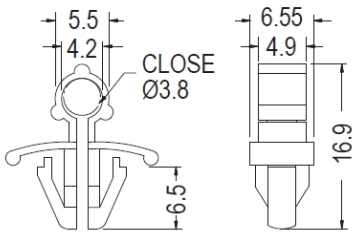
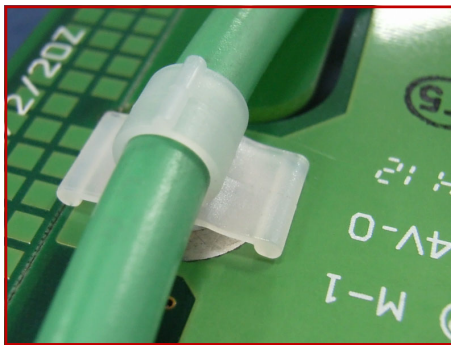

CHASSIS $\varnothing 6.5$
THICKNESS 1.2

PART NO	PACKAGE
DH-26	500

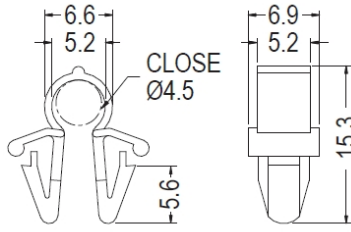

CHASSIS $\varnothing 6.0$
THICKNESS 2.0

PART NO	PACKAGE
DH-27	1000

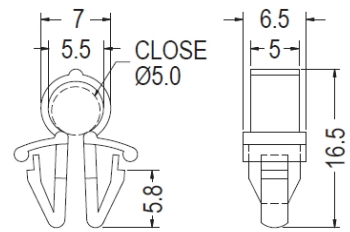

CHASSIS $\varnothing 6.5$
THICKNESS 2.0

PART NO	PACKAGE
DH-76	1000

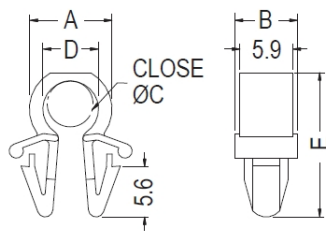
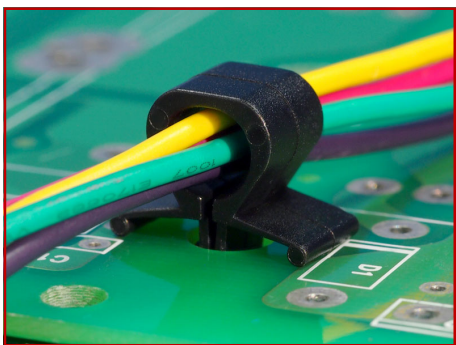

CHASSIS: $\varnothing G$
THICKNESS: T

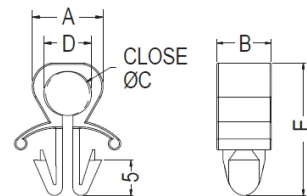

CHASSIS: $\varnothing G$
THICKNESS: T

WS-T671

PART NO	A	B	D	E	F	G	T	PACKAGE
WS-T671	10.15	7.8	6.3	6.82	18.9	6.5	2.5~4.0	500
WS-T718	9.2	6.9	5.0	6.2	16.0	6.0	2.0	1000
WS-T719	11.2	6.9	7.0	8.2	17.6	6.0	2.0	500
WS-T720	13.2	6.9	9.0	10.2	20.1	6.0	2.0	500

电线固定座 WIRE SADDLE 配线固定座



- ◆ MATERIAL : NYLON 66(UL)
- ◆ FLAME CLASS : 94V-2,94V-0
- ◆ COLOR : BLACK / NATURAL
- ◆ UNIT: mm

用途： 电线固定座,配线固定座固定电线于PC板或机板上，维修方便，不占空间。

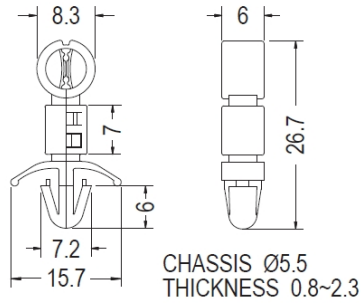

PART NO	PACKAGE
WS-T244	500

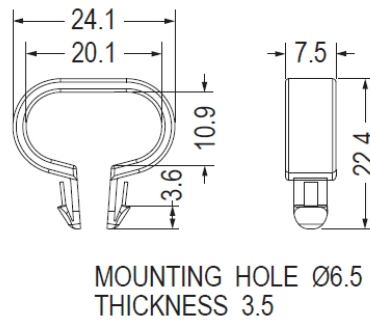
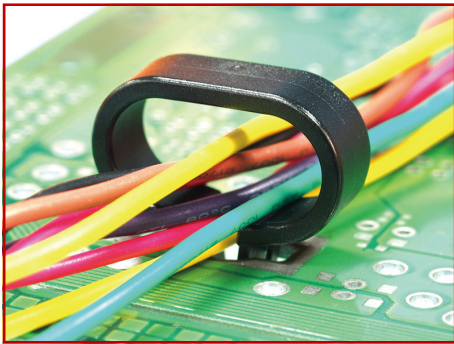

PART NO	PACKAGE
DH-78	500

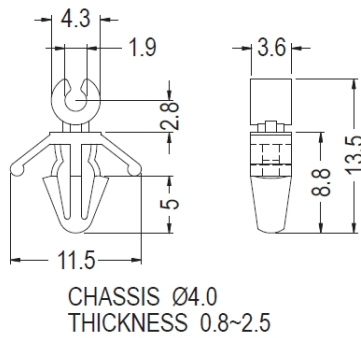
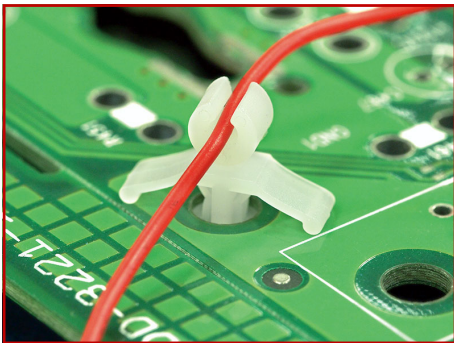

PART NO	PACKAGE
WS-T527	1000

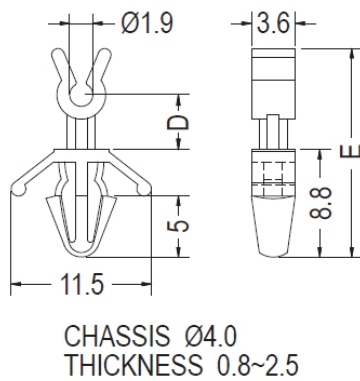
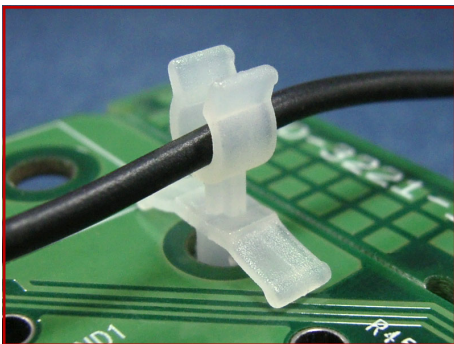

PART NO	D	E	PACKAGE
WS-T253	4.5	17.1	500
WS-T459	12.5	25.1	500

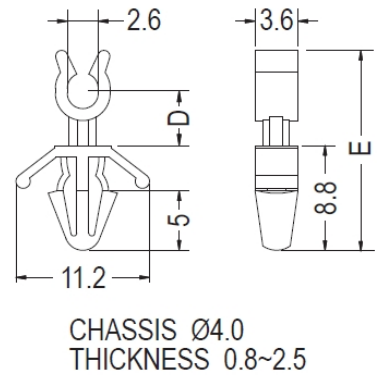

PART NO	D	E	PACKAGE
WS-T254	4.6	16.8	500
WS-T255	8.5	20.7	500

电线固定座

电线固定座 WIRE MOUNT 配线固定座



- ◆ MATERIAL : NYLON 66(UL)
- ◆ FLAME CLASS : 94V-2,94V-0
- ◆ COLOR : BLACK / NATURAL
- ◆ UNIT: mm

用途： 电线固定座,配线固定座固定电线于PC板或机板上， 维修方便， 不占空间。

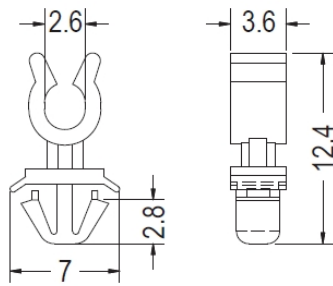

PART NO	PACKAGE
WS-T256	500

电线固定座

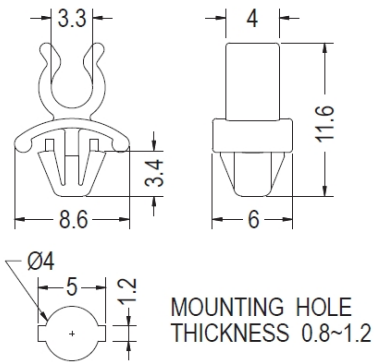
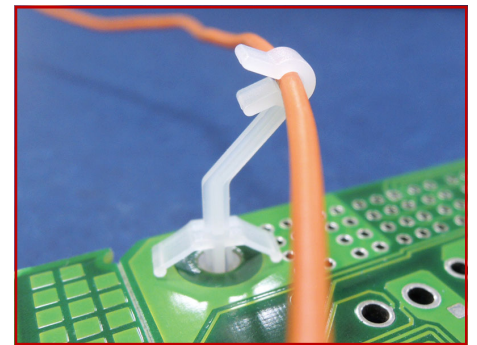
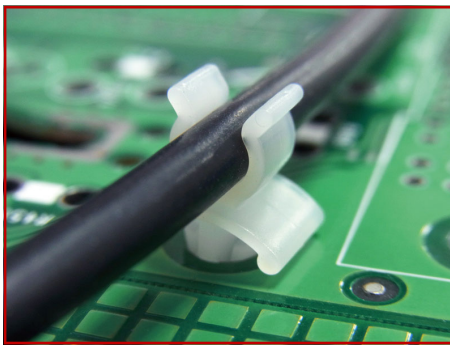

PART NO	PACKAGE
WS-T257	1000

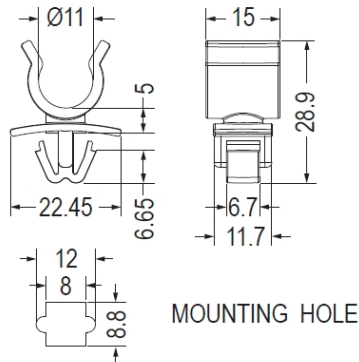

PART NO	PACKAGE
WS-T494	1000

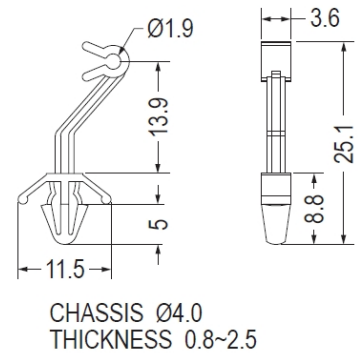

PART NO	PACKAGE
WS-T492	1000

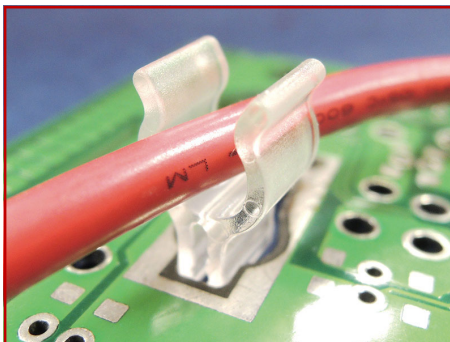

- ◆ MATERIAL : PC (UL)
- ◆ FLAME CLASS : 94V-2
- ◆ COLOR : TRANSPARENT
- ◆ UNIT: mm

用途： 电线固定座,配线固定座固定电线于PC板或机板上， 维修方便， 不占空间。

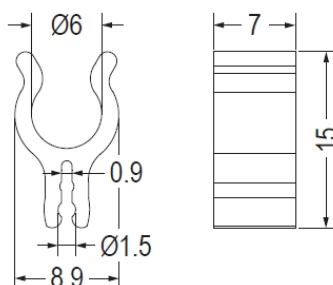

PART NO	PACKAGE
WS-T528	500

电线固定座 WIRE MOUNT 配线固定座

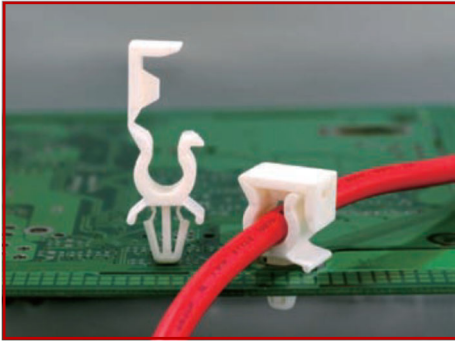

- ◆ MATERIAL : NYLON 66(UL)
- ◆ FLAME CLASS : 94V-2,94V-0
- ◆ COLOR : BLACK / NATURAL
- ◆ UNIT: mm

用途： 电线固定座,配线固定座固定电线于PC板或机板上，维修方便，不占空间。

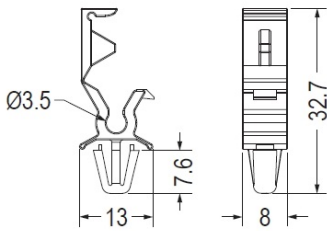

MOUNTING HOLE Ø6.0
THICKNESS 1.2

PART NO	PACKAGE
WS-T723	1000

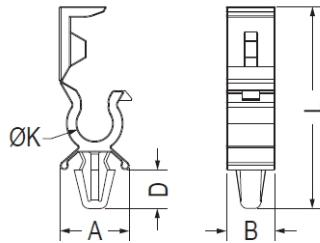

MOUNTING HOLE: ØG
THICKNESS 1.2

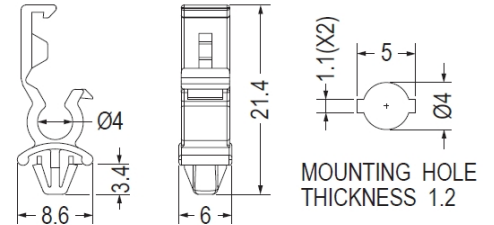

MOUNTING HOLE
THICKNESS 1.2

PART NO	PACKAGE
WS-T672	1000

PART NO	A	B	D	G	K	L	PACKAGE
WS-T721	13.6	9.63	7.6	6.0	7.0	39.80	1000
WS-T722	11.5	3.60	5.0	4.0	1.9	21.23	1000

电线固定座 CABLE CLIP 配线固定座

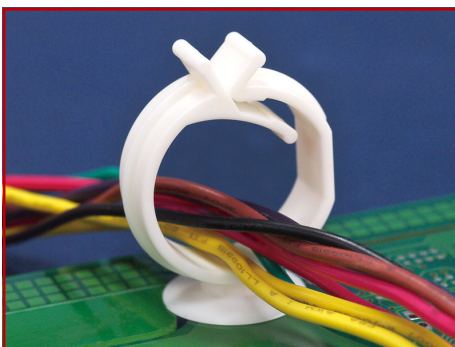

- ◆ MATERIAL : NYLON 66(UL)
- ◆ FLAME CLASS : 94V-2,94V-0
- ◆ COLOR : BLACK / NATURAL
- ◆ UNIT: mm

用途： 电线固定座,配线固定座固定电线于PC板或机板上，维修方便，不占空间。

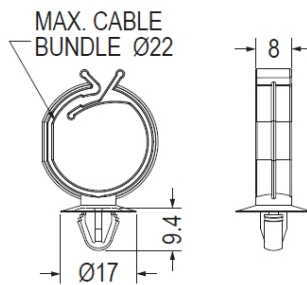

MOUNTING HOLE Ø6.5~Ø7.0
THICKNESS 0.6~2.0

PART NO	PACKAGE
WS-T615	500

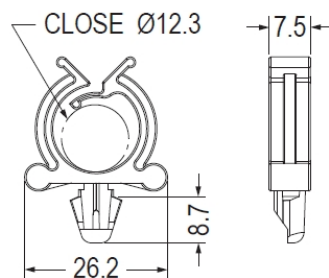

MOUNTING HOLE Ø6.35
THICKNESS 0.8~1.6

PART NO	PACKAGE
WS-T460	500

电线固定座 CABLE CLIP 配线固定座

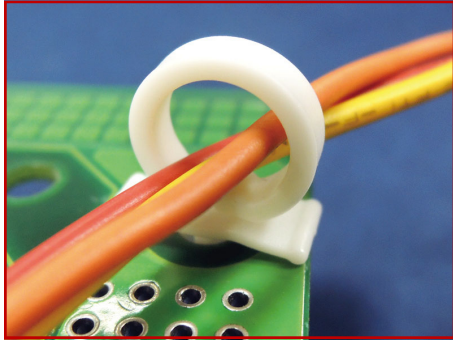

- ◆ MATERIAL : NYLON 66(UL)
- ◆ FLAME CLASS : 94V-2,94V-0
- ◆ COLOR : BLACK / NATURAL
- ◆ UNIT: mm

用途： 电线固定座,配线固定座固定电线于PC板或机板上，维修方便，不占空间。

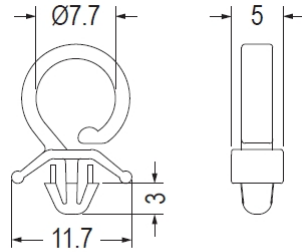

MOUNTING HOLE $\varnothing 4.0$
THICKNESS 0.6~2.0

PART NO	PACKAGE
WS-T493	1000

电线固定座

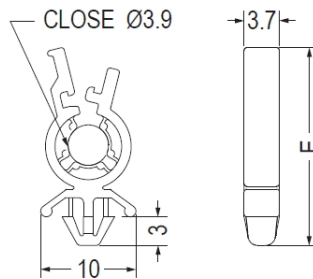
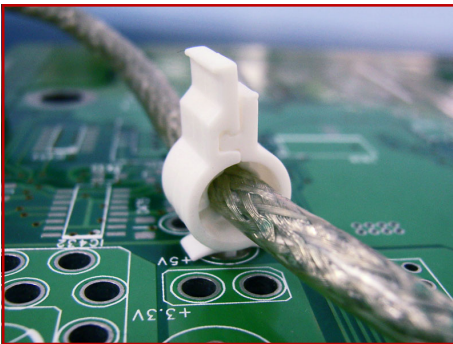

MOUNTING HOLE $\varnothing 4.0$
THICKNESS 0.8~2.0

PART NO	E	PACKAGE
WS-T248	20.80	500
WS-T249	25.85	500

电线固定座 WIRE SADDLE 配线固定座

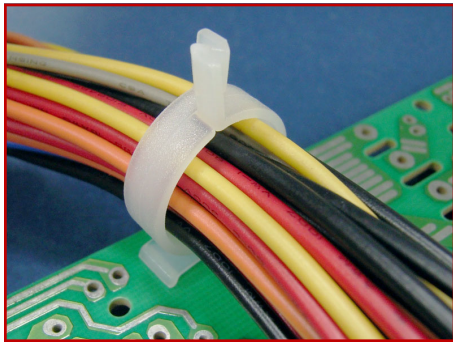

- ◆ MATERIAL : NYLON 66(UL)
- ◆ FLAME CLASS : 94V-2,94V-0
- ◆ COLOR : BLACK / NATURAL
- ◆ UNIT: mm

用途： 电线固定座,配线固定座固定电线于PC板或机板上，维修方便，不占空间。

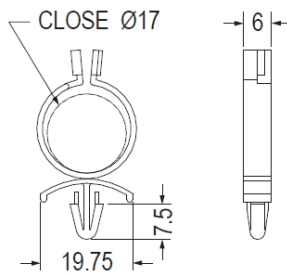

MOUNTING HOLE $\varnothing 4.8$
THICKNESS 1.0~3.2

PART NO	PACKAGE
DH-69	500

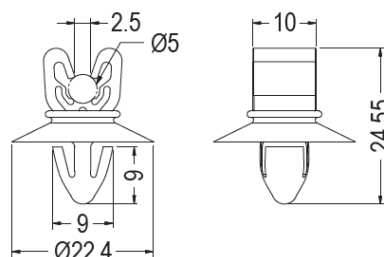

MOUNTING HOLE $\varnothing 8.0$
THICKNESS 1.2

PART NO	PACKAGE
WS-T083	500

电线固定座 WIRE SADDLE 配线固定座

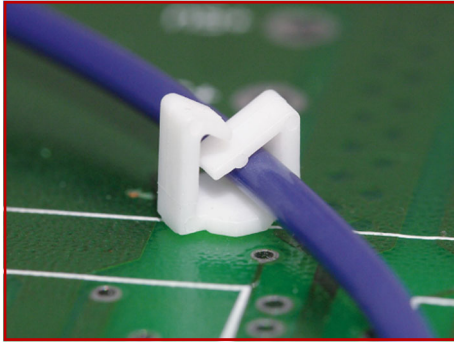

- ◆ MATERIAL : NYLON 66(UL)
- ◆ FLAME CLASS : 94V-2,94V-0
- ◆ COLOR : BLACK / NATURAL
- ◆ UNIT: mm

用途： 电线固定座,配线固定座固定电线于PC板或机板上， 维修方便， 不占空间。

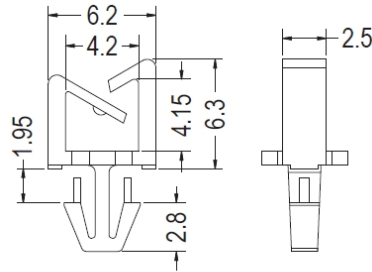

MOUNTING HOLE Ø3.0
THICKNESS 1.6

PART NO	PACKAGE
WS-T737	1000



- ◆ MATERIAL : NYLON 66(UL)
- ◆ FLAME CLASS : 94V-2,94V-0
- ◆ COLOR : BLACK / NATURAL
- ◆ UNIT: mm

用途： 电线固定座,配线固定座,用于电子、计算机内部电线固定， 装配容易， 美观不脱落。

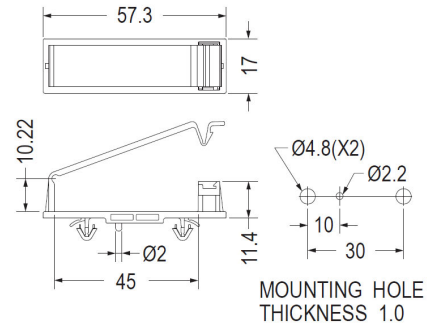
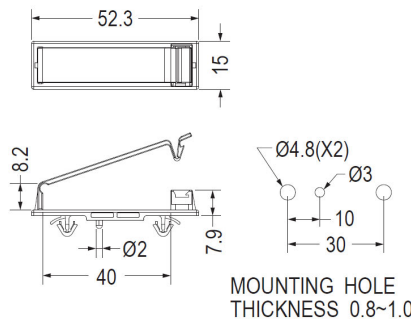

PART NO	PACKAGE
WS-T741	200

PART NO	PACKAGE
WS-T907	200

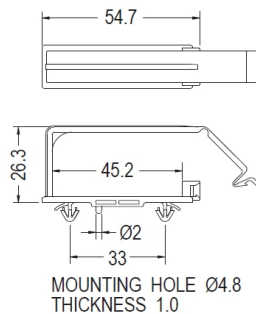

PART NO	PACKAGE
WS-T742	100

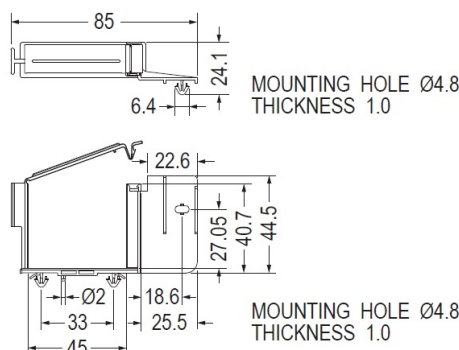

PART NO	PACKAGE
WS-T743	50

电线固定座 WIRE SADDLE 配线固定座

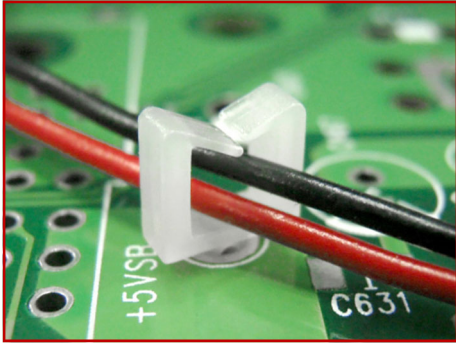

- ◆ MATERIAL : NYLON 66(UL)
- ◆ FLAME CLASS : 94V-2,94V-0
- ◆ COLOR : BLACK / NATURAL
- ◆ UNIT: mm

用途： 电线固定座,配线固定座,用于电子、计算机内部电线固定, 装配容易, 美观不脱落。

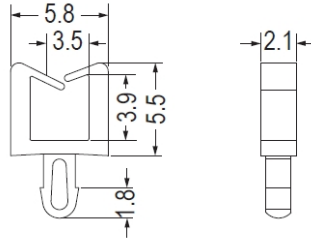

CHASSIS Ø2.0
THICKNESS 1.6~1.8

PART NO	PACKAGE
WS-T240	2000

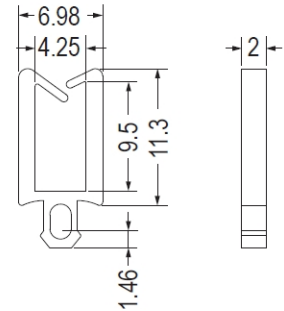

P.C.B Ø2.8
THICKNESS 2.0

PART NO	PACKAGE
WS-T220	2000

电线固定座

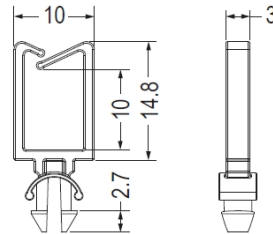

CHASSIS Ø4.4
THICKNESS 2.0~3.0

PART NO	PACKAGE
WS-T749	1000

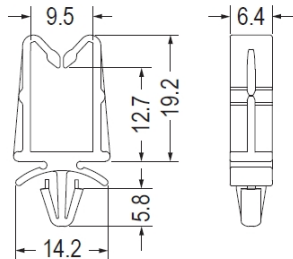

CHASSIS Ø4.7~Ø4.9
THICKNESS 0.8~2.0

PART NO	PACKAGE
WS-T750	500



- ◆ MATERIAL : NYLON 66(UL)
- ◆ FLAME CLASS : 94V-2,94V-0
- ◆ COLOR : BLACK / NATURAL
- ◆ UNIT: mm

用途： 电线固定座,配线固定座,固定电线于PC板或机板上, 维修方便, 不占空间。

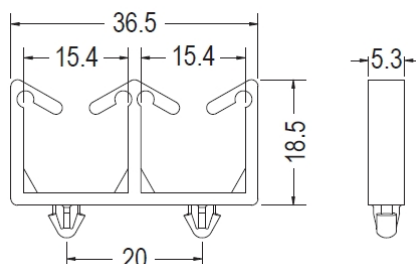

CHASSIS Ø4.0
THICKNESS 1.0

PART NO	PACKAGE
WS-T751	500

电线固定座 WIRE SADDLE 配线固定座

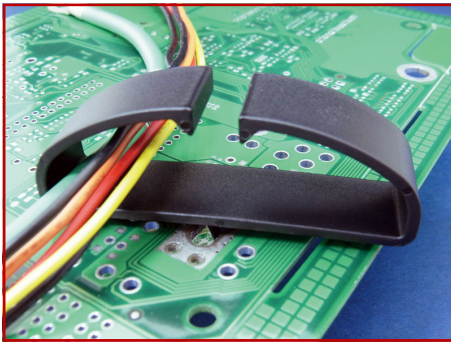

- ◆ MATERIAL : NYLON 66(UL)
- ◆ FLAME CLASS : 94V-2,94V-0
- ◆ COLOR : BLACK / NATURAL
- ◆ UNIT: mm

用途： 电线固定座,配线固定座固定电线于PC板或机板上，维修方便，不占空间。

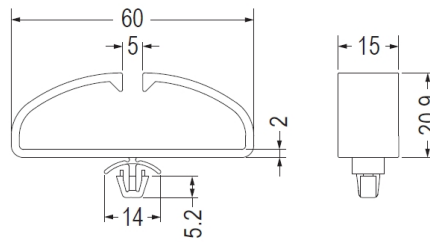

CHASSIS Ø6.0
THICKNESS 0.8~2.5

PART NO	PACKAGE
WS-T069	500

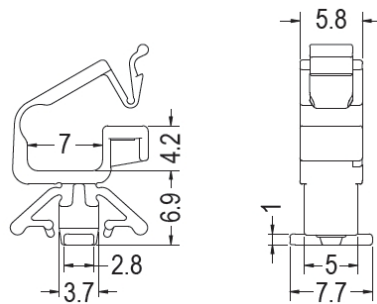

MOUNTING HOLE
THICKNESS 1.0~1.6

PART NO	PACKAGE
WS-T753	1000

电线固定座

电线固定座 FLAT CABLE CLAMP 配线固定座 螺丝固定



- ◆ MATERIAL : NYLON 66(UL)
- ◆ FLAME CLASS : 94V-2,94V-0
- ◆ COLOR : BLACK / NATURAL
- ◆ UNIT: mm

用途： 电线固定座,配线固定座,配合螺丝，用于电子、计算机内部电线固定，装配容易，美观不脱落。。

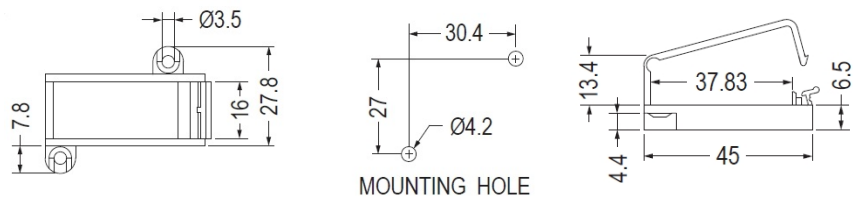

MOUNTING HOLE

PART NO	PACKAGE
WS-T159	200

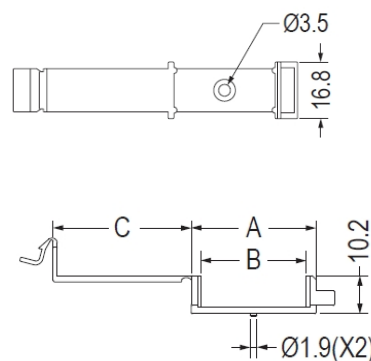
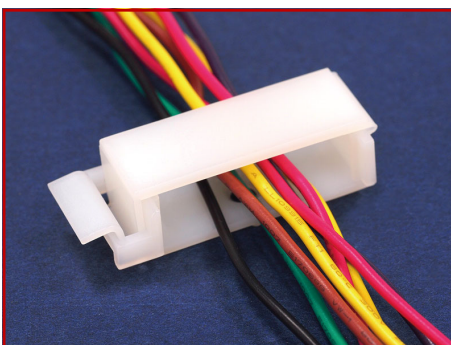

FOR M3 SCREW
MOUNTING HOLE

PART NO	A	B	C	PACKAGE
WS-T646	33.6	28.4	37.2	100
WS-T647	47.8	42.6	51.4	100

电线固定座 FLAT CABLE CLAMP 配线固定座 螺丝固定

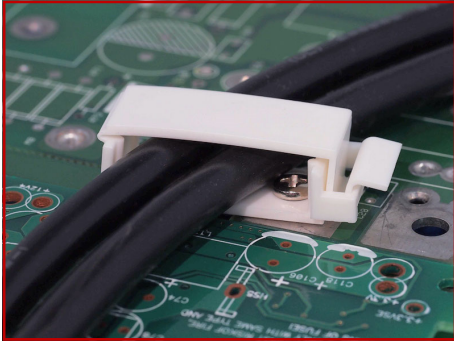

- ◆ MATERIAL : NYLON 66(UL)
- ◆ FLAME CLASS : 94V-2,94V-0
- ◆ COLOR : BLACK / NATURAL
- ◆ UNIT: mm

用途： 电线固定座,配线固定座,用于电子、计算机内部电线固定, 装配容易, 美观不脱落。

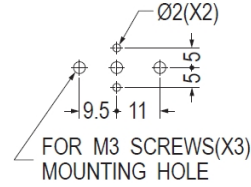
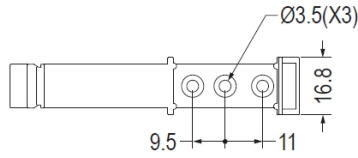

PART NO	PACKAGE
WS-T677	100

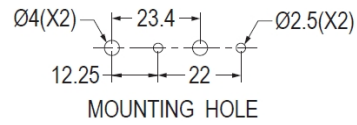
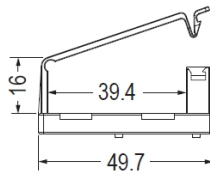
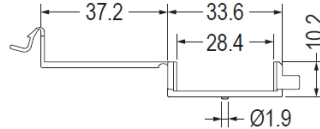

PART NO	PACKAGE
WS-T410	100

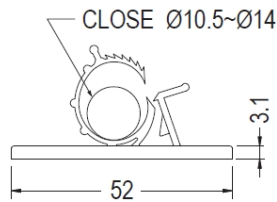
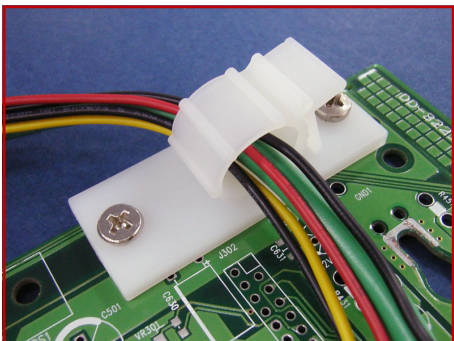
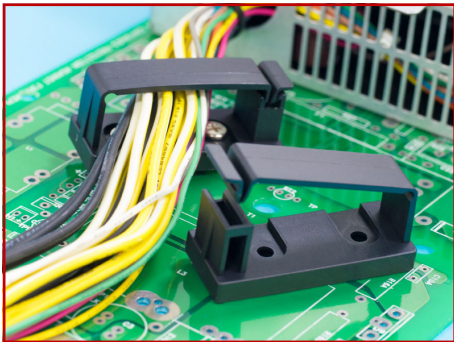
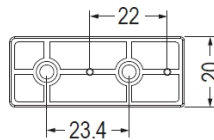

PART NO	PACKAGE
WS-T024	1000

电线固定座 WIRE CLIP 配线固定座 自粘式配线固定座 背胶式 螺丝固定

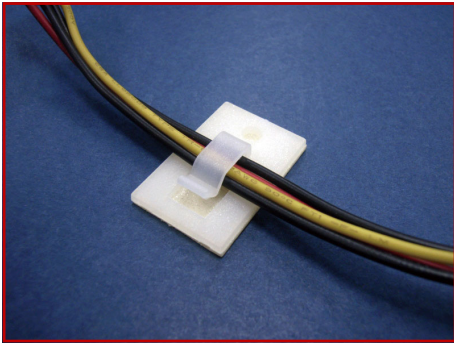

- ◆ MATERIAL : NYLON 66(UL)
- ◆ FLAME CLASS : 94V-2,94V-0
- ◆ COLOR : BLACK / NATURAL
- ◆ UNIT: mm

用途： 电线固定座,自粘式配线固定座
可用背胶或螺丝固定,可快速
拆卸电线,维修方便,不占空
间。

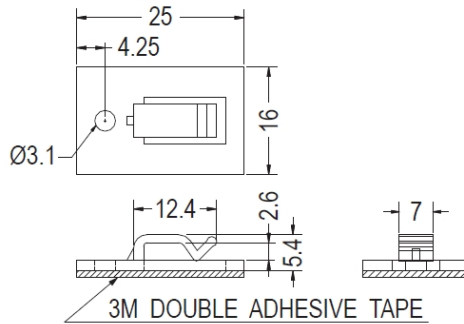

PART NO	PACKAGE
WS-T299	500

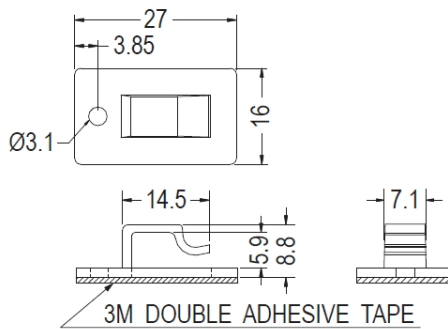
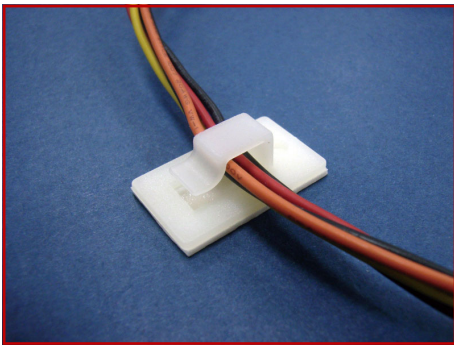

PART NO	PACKAGE
WS-T300	500

电线固定座 FLAT CABLE CLAMP 配线固定座 自粘式配线固定座 背胶式 螺丝固定

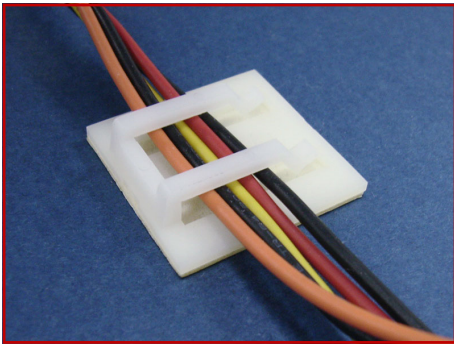

- ◆ MATERIAL : NYLON 66(UL)
- ◆ FLAME CLASS : 94V-2,94V-0
- ◆ COLOR : BLACK / NATURAL
- ◆ UNIT: mm

用途： 电线固定座,自粘式配线固定座
可用背胶或螺丝固定,可快速
拆卸电线,维修方便,不占空
间。

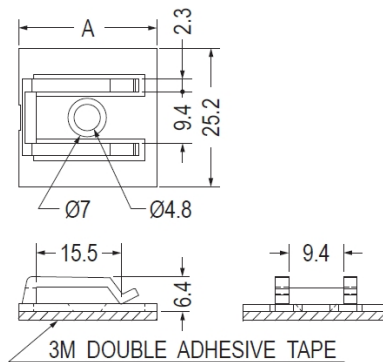

PART NO	A	PACKAGE
WS-T141	25.2	500
WS-T142	24.2	500

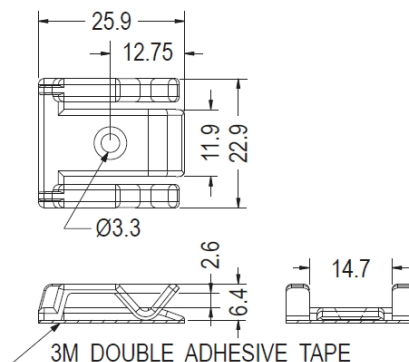
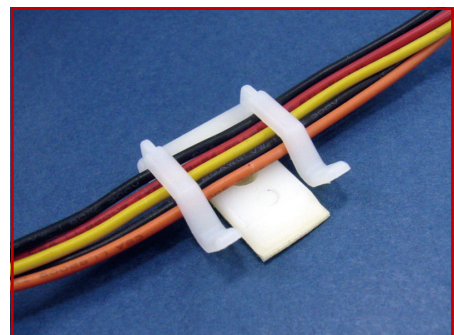

PART NO	PACKAGE
WS-T143	500

电线固定座 WIRE SADDLE 自粘式配线固定座 螺丝固定 背胶式

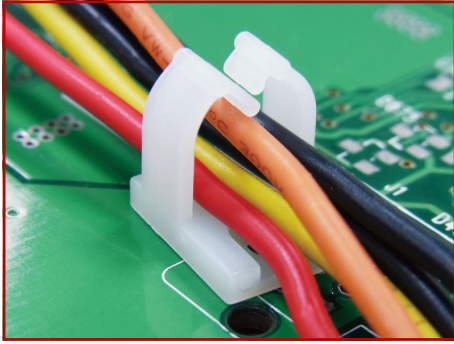

- ◆ MATERIAL : NYLON 66(UL)
- ◆ FLAME CLASS : 94V-2,94V-0
- ◆ COLOR : BLACK / NATURAL
- ◆ UNIT: mm

用途： 电线固定座,自粘式配线固定座，背胶式,亦可锁螺丝，可快速拆卸，固定电线，维修方便，不占空间。

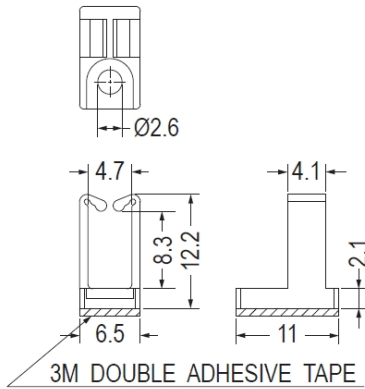

PART NO	PACKAGE
WS-T892	1000

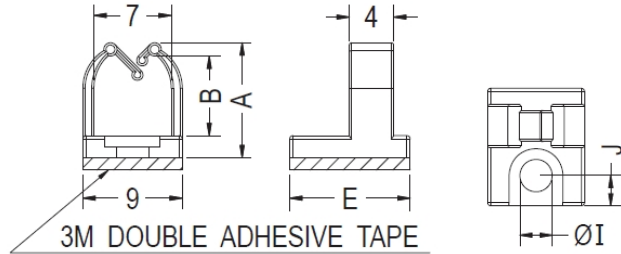

PART NO	A	B	E	I	J	PACKAGE
WS-T850	10.4	7.2	10.9	3.0	2.8	1000
WS-T851	14.0	10.8	10.9	2.7	2.85	1000
WS-T852	10.4	7.2	10.9	2.6	2.8	1000
WS-T874	14.0	9.8	11.0	2.7	2.9	1000
WS-T875	10.4	7.2	12.4	3.2	3.3	1000

电线固定座

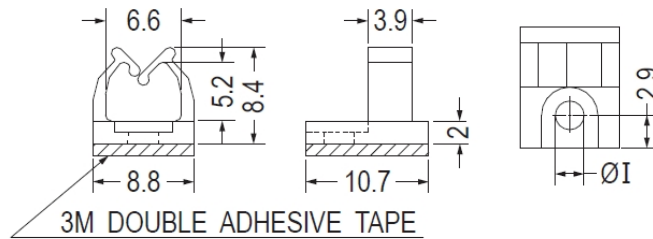
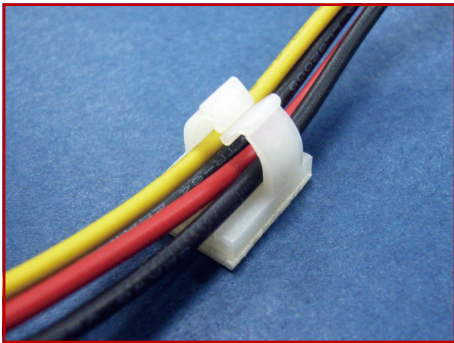

PART NO	I	PACKAGE
WS-T774	3.0	1000
WS-T876	1.8	1000

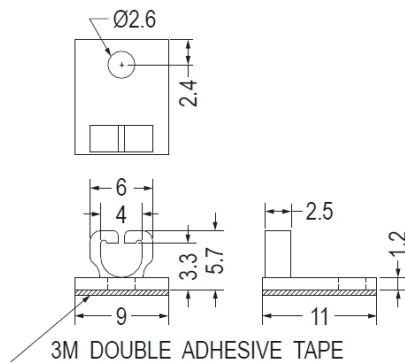
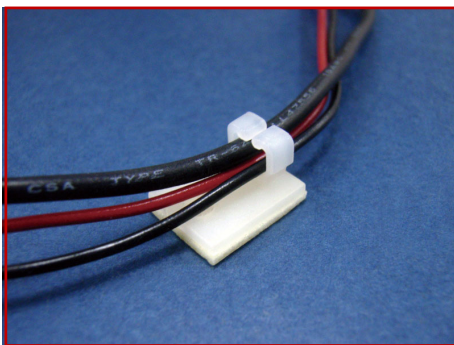

PART NO	PACKAGE
WS-T779	1000

电线固定座 WIRE SADDLE 配线固定座 螺丝固定

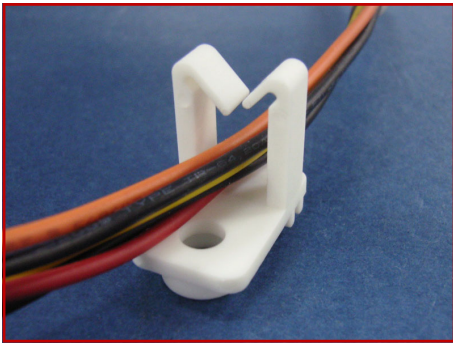

- ◆ MATERIAL : NYLON 66(UL)
- ◆ FLAME CLASS : 94V-2,94V-0
- ◆ COLOR : BLACK / NATURAL
- ◆ UNIT: mm

用途： 电线固定座,配线固定座 配合螺丝，固定电线，整齐美观,维修方便，不占空间。

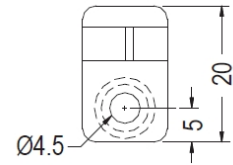
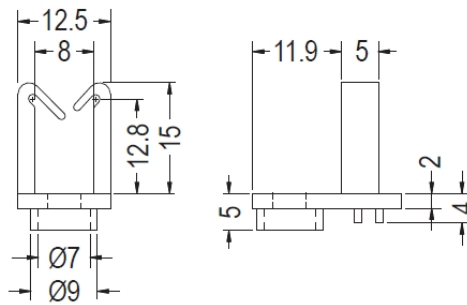

PART NO	PACKAGE
WS-T777	1000

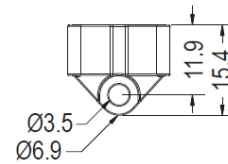
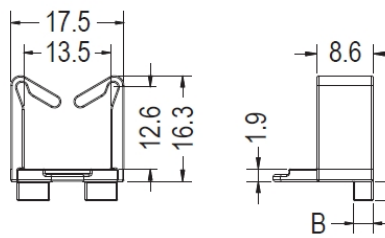
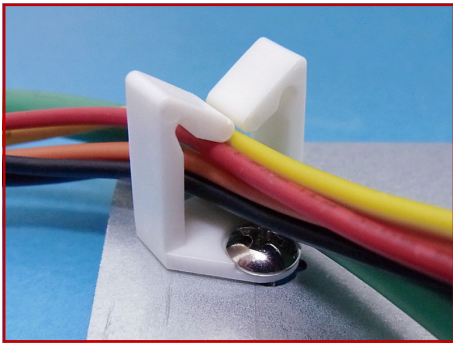

PART NO	D	E	PACKAGE
WS-T778	3.0	3.0	1000
WS-T853	-	-	1000

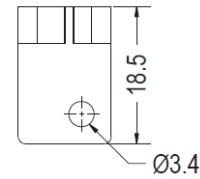
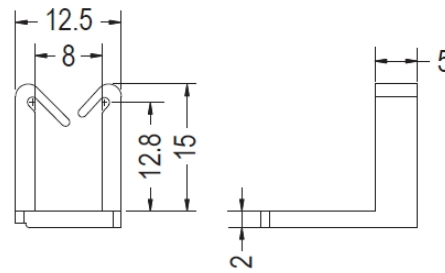
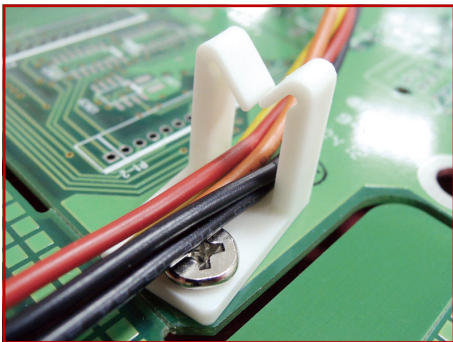

PART NO	PACKAGE
WS-T854	1000

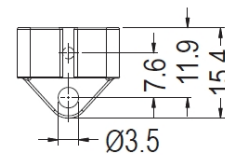
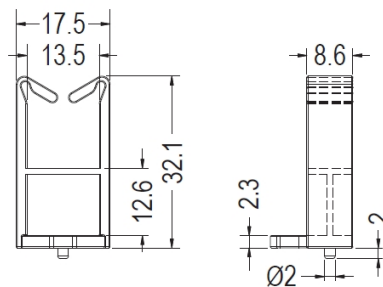
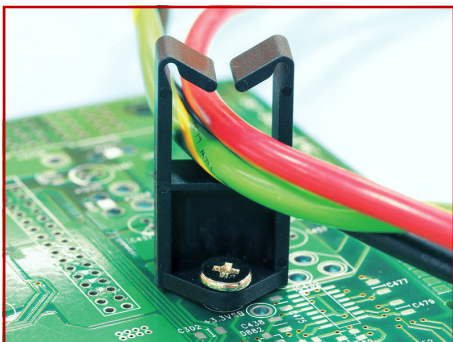

PART NO	PACKAGE
WS-T884	1000

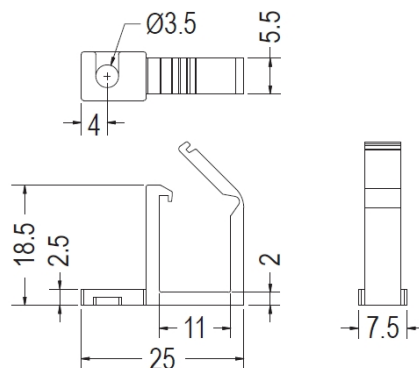
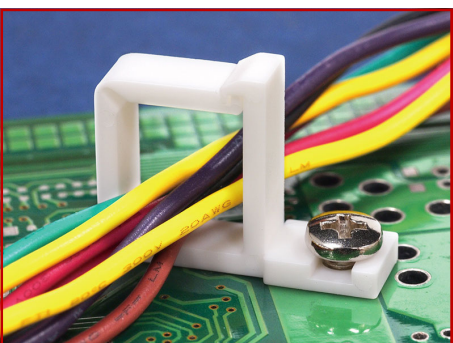

PART NO	PACKAGE
WS-T620	1000

电线固定座

电线固定座 WIRE CLIP 自粘式配线固定座 螺丝固定 背胶式



- ◆ MATERIAL : NYLON 66(UL)
- ◆ FLAME CLASS : 94V-2,94V-0
- ◆ COLOR : BLACK / NATURAL
- ◆ UNIT: mm

用途: 电线固定座,自粘式配线固定座,可背胶或使用螺丝固定,固定电线,整齐美观。

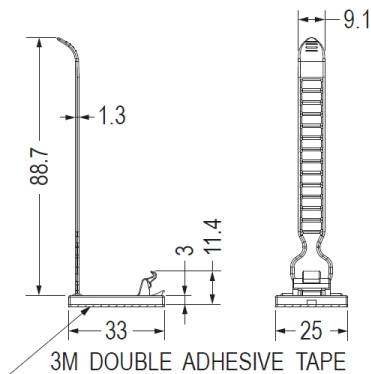

PART NO	PACKAGE
WS-T397	200

电线固定座 WIRE CLIP 配线固定座 螺丝固定

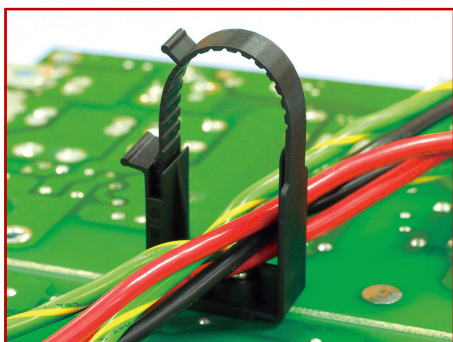

- ◆ MATERIAL : NYLON 66(UL)
- ◆ FLAME CLASS : 94V-2,94V-0
- ◆ COLOR : BLACK / NATURAL
- ◆ UNIT: mm

用途: 电线固定座,配线固定座,固定电线于机壳上,维修方便,不占空间。

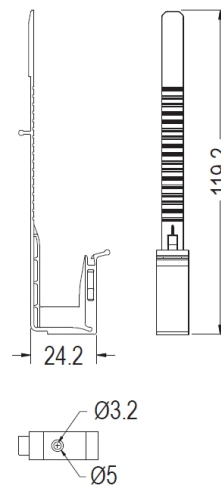
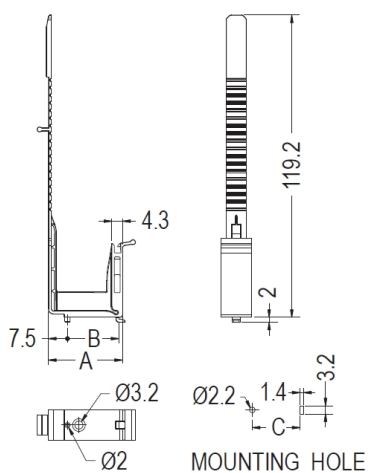

PART NO	A	B	C	PACKAGE
WS-T496	29.2	20.2	18.9	500
WS-T497	24.2	15.2	13.9	500

PART NO	PACKAGE
WS-T563	500

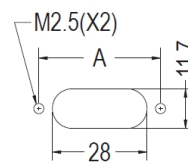
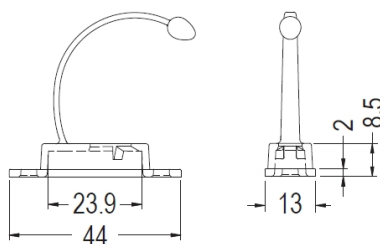
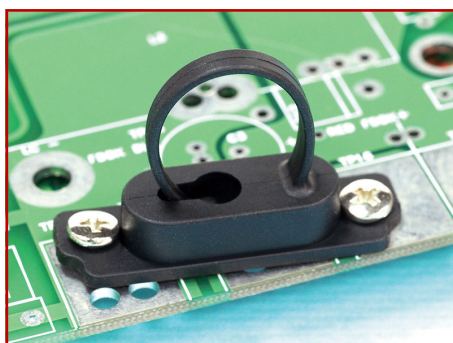

MOUNTING HOLE

WS-T695

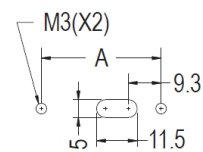

MOUNTING HOLE

WS-T562

PART NO	A	PACKAGE
WS-T562	34.0	200
WS-T695	36.0	200

电线固定座 WIRE SADDLE 配线固定座 螺丝固定

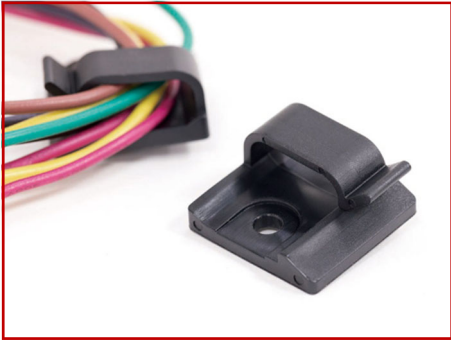

- ◆ MATERIAL : NYLON 66(UL)
- ◆ FLAME CLASS : 94V-2,94V-0
- ◆ COLOR : BLACK / NATURAL
- ◆ UNIT: mm

用途： 电线固定座,配线固定座 配合螺丝, 固定电线, 整齐美观,维修方便, 不占空间。

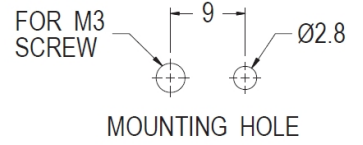
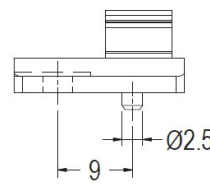
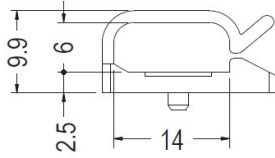

PART NO	PACKAGE
WS-T738	1000

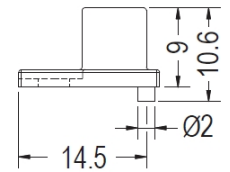
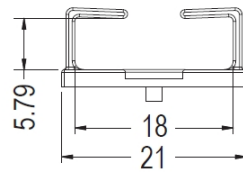
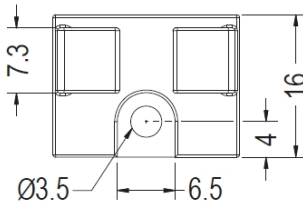
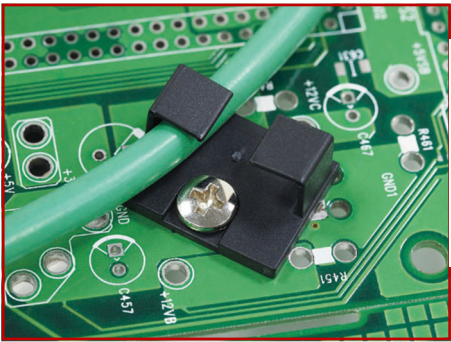

PART NO	PACKAGE
WS-T736	1000

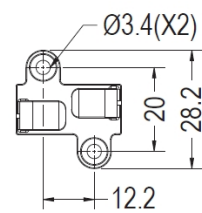
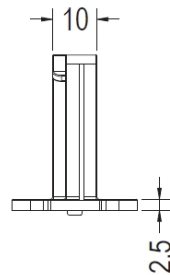
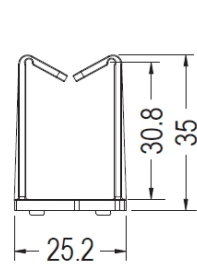
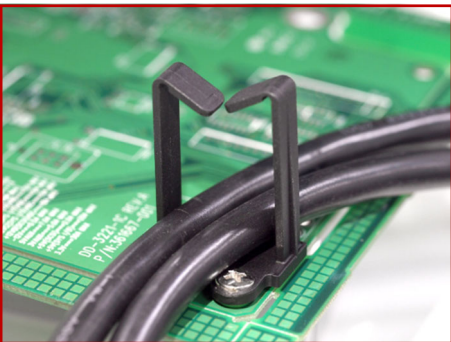

PART NO	PACKAGE
WS-T746	500

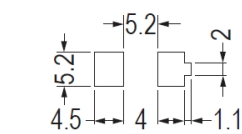
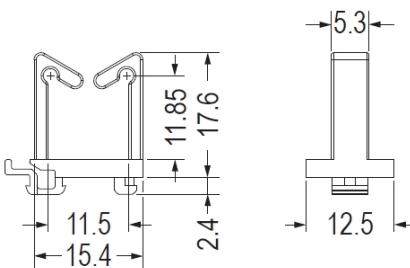

RECOMMEND MOUNTING HOLE THICKNESS 1.0

PART NO	PACKAGE
WS-T747	500

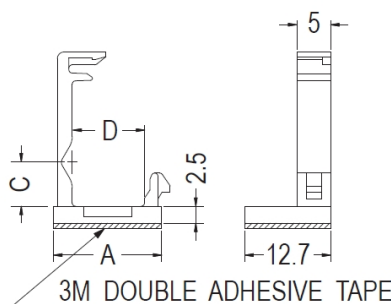
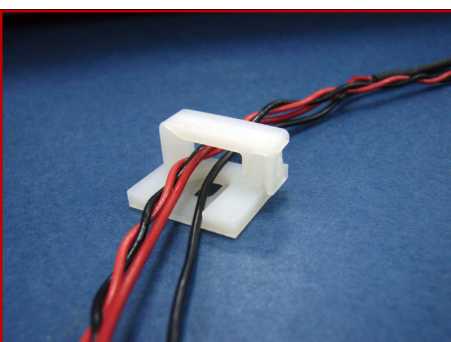

用途： 电线固定座,自粘式配线固定座 可用背胶或螺丝固定, 可快速捆扎及解开电线。

PART NO	A	B	C	PACKAGE
WS-T337	16.0	6.5	10.7	500
WS-T338	21.6	11.7	16.3	500

电线固定座

电线固定座 U-CLAMP 配线固定座 螺丝固定 Two-Piece Locking Clamp

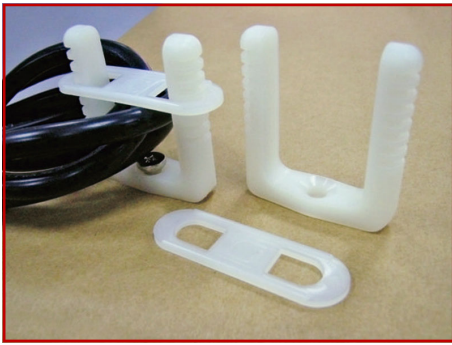

- ◆ MATERIAL : NYLON 66(UL)
- ◆ FLAME CLASS : 94V-2,94V-0
- ◆ COLOR : BLACK / NATURAL
- ◆ UNIT: mm

用途： 电线固定座,配线固定座 ,配合螺丝, 固定电线, 整齐美观。

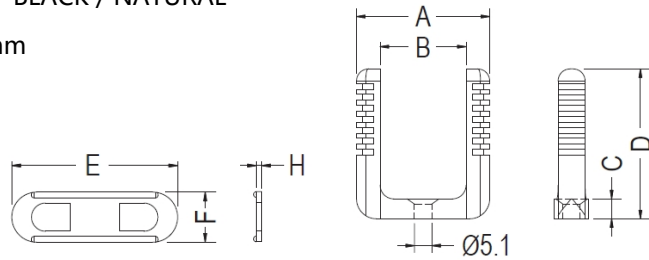

PART NO	A	B	C	D	E	F	H	PACKAGE
WS-T129	38.9	25.1	5.8	43.7	47.2	14.2	1.5	100
WS-T130	55.2	37.0	7.9	56.6	62.7	17.8	1.2	100

电线固定座 CABLE CLAMP 配线固定座 螺丝固定



- ◆ MATERIAL : NYLON 66(UL)
- ◆ FLAME CLASS : 94V-2,94V-0
- ◆ COLOR : BLACK / NATURAL
- ◆ UNIT: mm

用途： 电线固定座,配线固定座 ,适用螺丝M4、长12, 可快速拆卸, 固定电线, 维修方便, 不占空间。

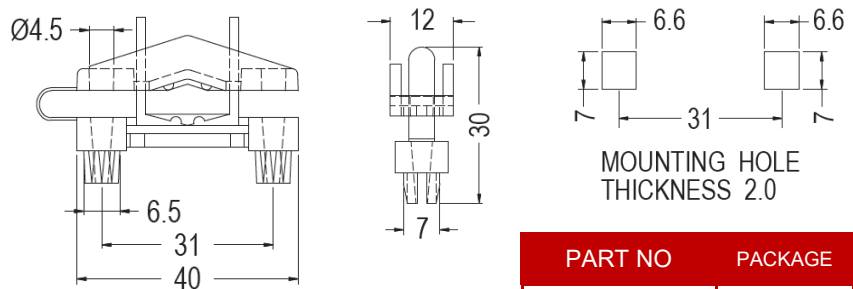

PART NO	PACKAGE
WS-T124	500



- ◆ MATERIAL : NYLON 66(UL)
- ◆ FLAME CLASS : 94V-2,94V-0
- ◆ COLOR : BLACK / NATURAL
- ◆ UNIT: mm

用途： 电线固定座,配线固定座 ,用于机器上之电线固定。

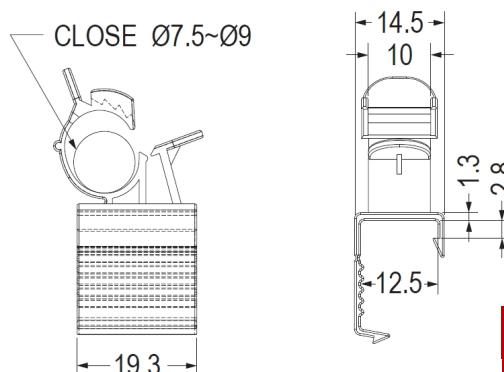

PART NO	PACKAGE
WS-T025	500

电线固定座 FLAT CABLE CLAMP 自粘式配线固定座 背胶式

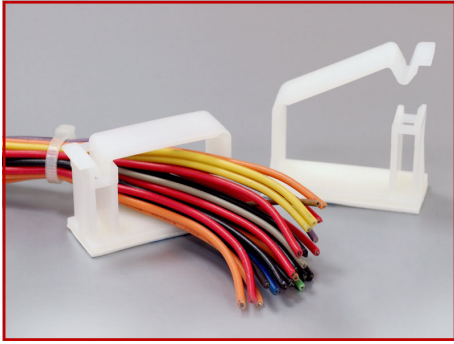

- ◆ MATERIAL : NYLON 66(UL)
- ◆ FLAME CLASS : 94V-2,94V-0
- ◆ COLOR : BLACK / NATURAL
- ◆ UNIT: mm

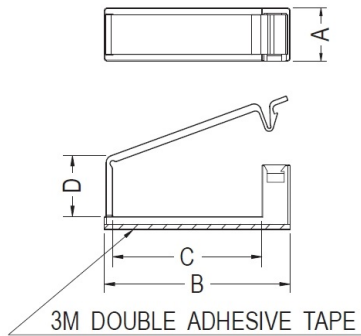

PART NO	A	B	C	D	PACKAGE
WS-T893	12.7	44.8	36.0	14.6	200
WS-T894	12.7	61.0	52.2	10.7	200

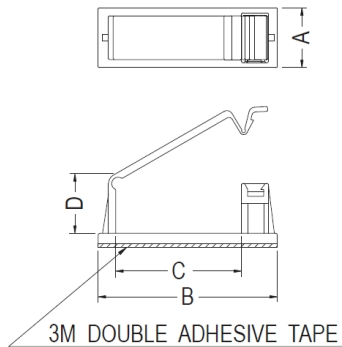

PART NO	A	B	C	D	PACKAGE
WS-T364	15.0	38.5	27.0	11.6	200
WS-T365	15.0	45.0	31.6	14.95	200
WS-T366	19.0	78.2	64.6	14.8	100
WS-T367	19.8	66.5	52.6	12.1	200
WS-T641	14.8	38.0	26.9	24.1	200
WS-T642	14.8	38.0	26.9	30.1	200

用途： 电线固定座,自粘式配线固定座背胶式, 用于电子、计算机内部电线固定, 装配容易, 美观不脱落。

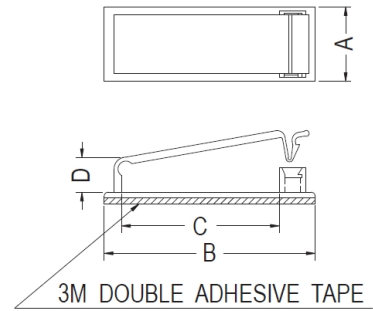

PART NO	A	B	C	D	PACKAGE
WS-T132	19.7	77.6	64.0	9.95	50
WS-T133	19.0	53.5	40.0	8.9	100
WS-T134	19.0	45.8	32.0	8.44	200
WS-T895	16.0	50.0	37.6	15.2	200

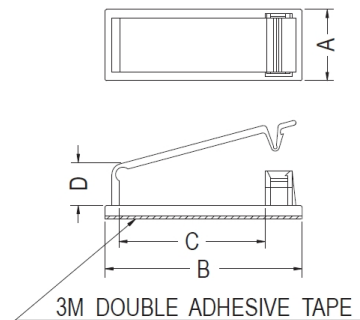

PART NO	A	B	C	D	PACKAGE
WS-T135	19.8	45.4	31.8	15.2	200
WS-T136	19.3	53.5	39.7	12.0	200
WS-T137	19.3	53.5	39.7	11.7	200
WS-T138	19.2	53.5	39.7	9.5	200
WS-T640	18.7	55.5	41.3	9.6	200

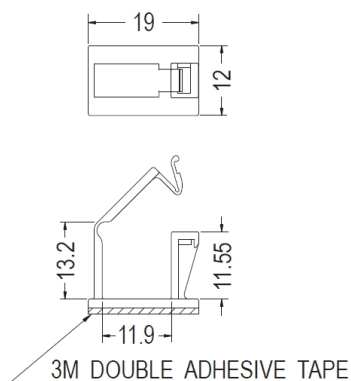
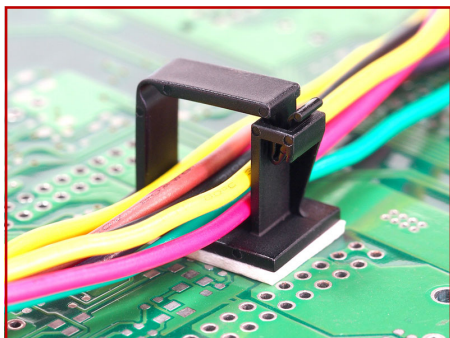

PART NO	PACKAGE
WS-T644	500

电线固定座 FLAT CABLE CLAMP 自粘式配线固定座 背胶式

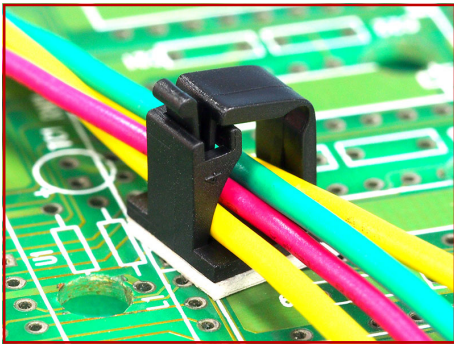

- ◆ MATERIAL : NYLON 66(UL)
- ◆ FLAME CLASS : 94V-2,94V-0
- ◆ COLOR : BLACK / NATURAL
- ◆ UNIT: mm

用途： 电线固定座,自粘式配线固定座，背胶式，用于电子、计算机内部电线固定，装配容易，美观不脱落。

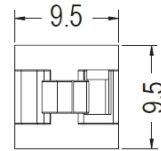
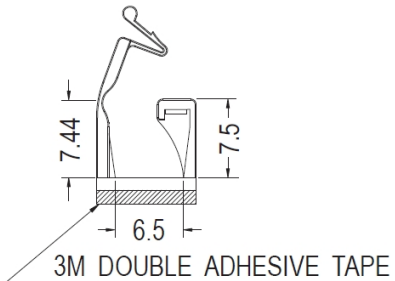

PART NO	PACKAGE
WS-T590	1000

电线固定座

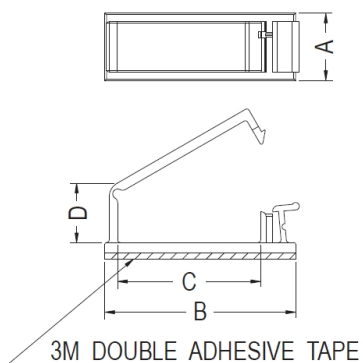
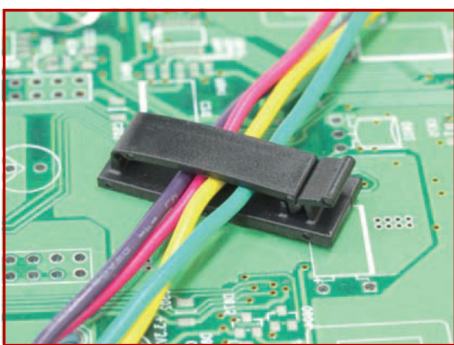

PART NO	A	B	C	D	PACKAGE
WS-T156	12.7	40.7	31.5	5.5	200
WS-T157	12.7	36.0	27.0	11.2	200
WS-T158	15.0	36.0	27.0	13.9	200
WS-T361	12.5	35.8	26.8	8.3	200
WS-T362	12.7	26.2	17.0	4.55	200
WS-T363	12.9	72.3	63.1	6.7	100
WS-T638	10.0	26.2	17.0	11.6	100
WS-T639	10.0	28.0	19.0	3.4	200
WS-T897	12.7	41.0	32.0	12.4	200

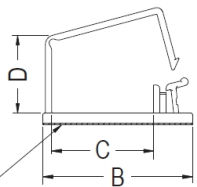
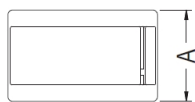

3M DOUBLE ADHESIVE TAPE

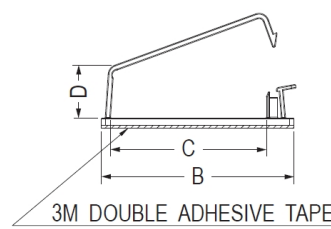
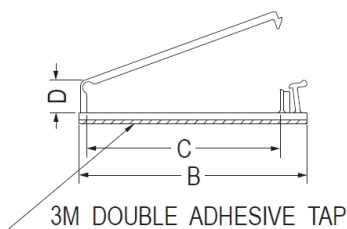
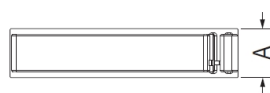

PART NO	A	B	C	D	PACKAGE
WS-T368	18.8	30.7	20.9	16.0	100

PART NO	A	B	C	D	PACKAGE
WS-T676	12.7	59.0	50.0	8.4	200

PART NO	A	B	C	D	PACKAGE
WS-T896	15.0	66.7	54.0	20.0	100

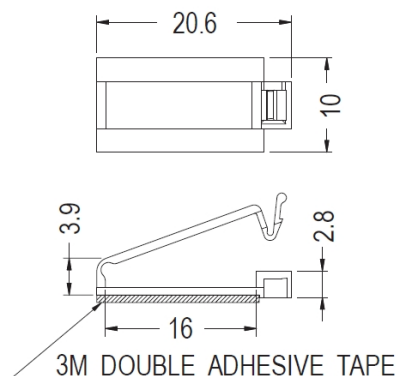
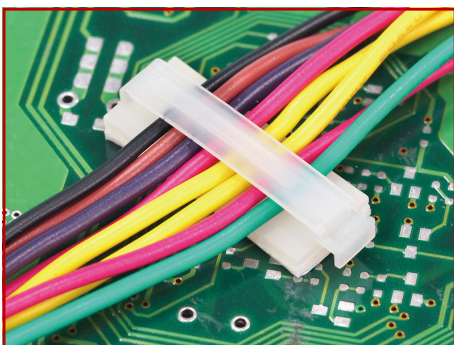

PART NO	PACKAGE
WS-T013	500

电线固定座 FLAT CABLE CLAMP 自粘式配线固定座 背胶式

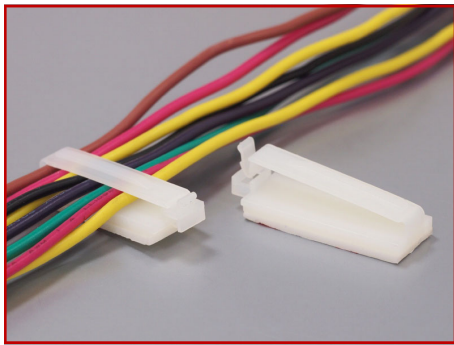

- ◆ MATERIAL : NYLON 66(UL)
- ◆ FLAME CLASS : 94V-2,94V-0
- ◆ COLOR : BLACK / NATURAL
- ◆ UNIT: mm

用途： 电线固定座,自粘式配线固定座背胶式, 用于电子、计算机内部电线固定, 装配容易, 美观不脱落。

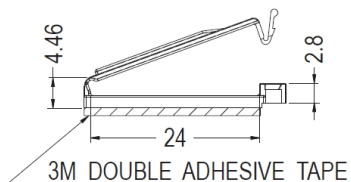
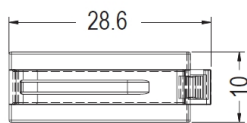

PART NO	PACKAGE
WS-T645	500

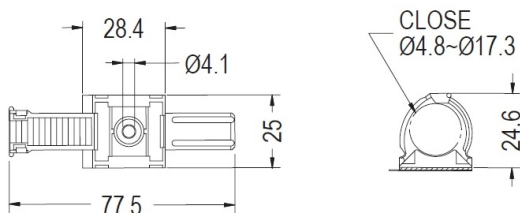
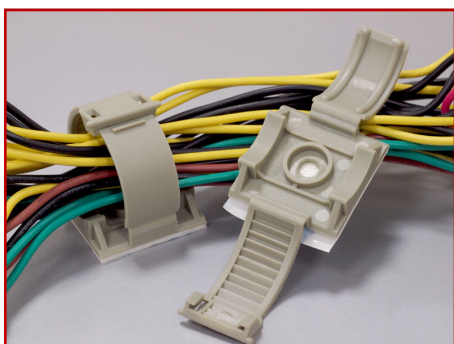

PART NO	PACKAGE
WS-T128	500

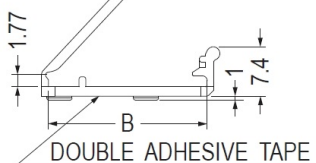
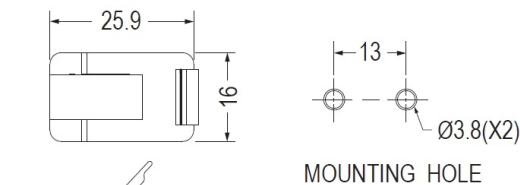
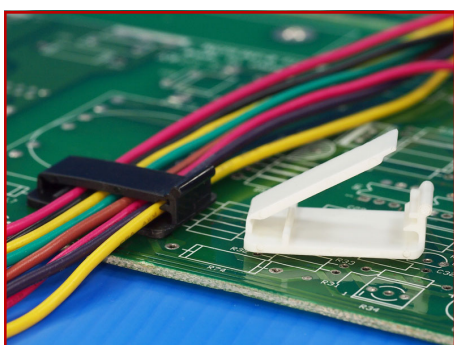

PART NO	B	PACKAGE
WS-T411	23.9	1000
WS-T412	23.85	1000

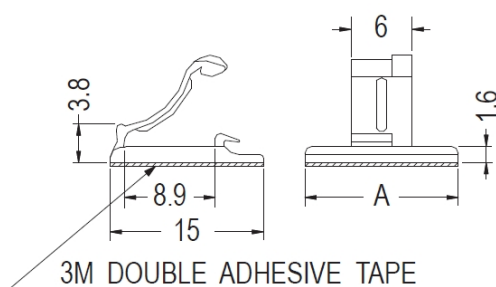
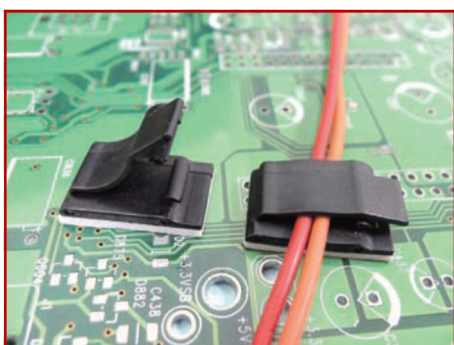

PART NO	A	PACKAGE
WS-T306	15.0	1000
WS-T307	6.0	1000

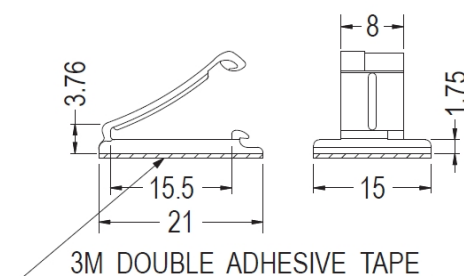

PART NO	PACKAGE
WS-T308	1000

电线固定座

电线固定座 FLAT CABLE CLAMP 自粘式配线固定座 背胶式



- ◆ MATERIAL : NYLON 66(UL)
- ◆ FLAME CLASS : 94V-2,94V-0
- ◆ COLOR : BLACK / NATURAL
- ◆ UNIT: mm

用途： 电线固定座,自粘式配线固定座，背胶式，用于电子、计算机内部电线固定，装配容易，美观不脱落。

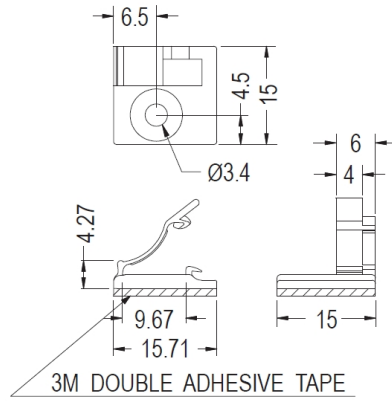

PART NO	PACKAGE
WS-T309	1000

电线固定座

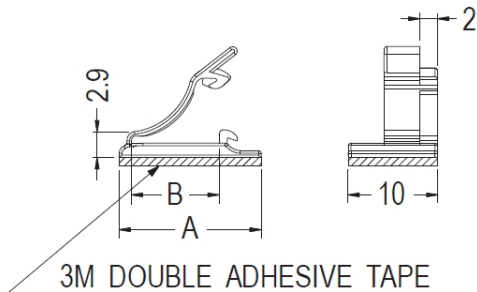
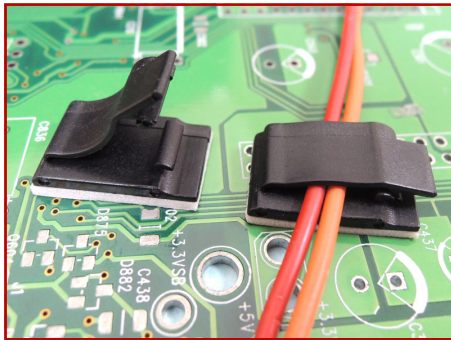

PART NO	A	B	PACKAGE
WS-T310	15.9	9.8	1000
WS-T376	17.6	11.5	1000

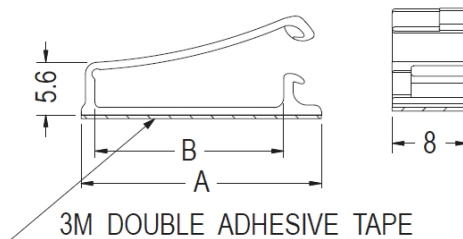
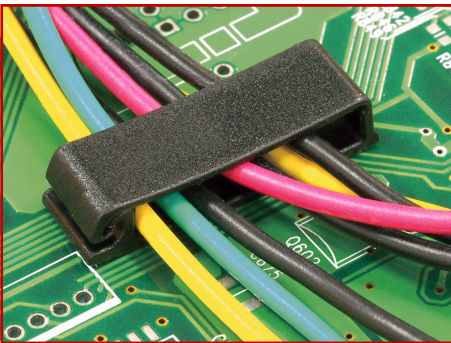

PART NO	A	B	PACKAGE
WS-T534	25.5	20.0	1000
WS-T535	35.5	30.0	1000

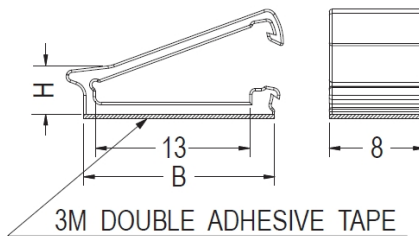
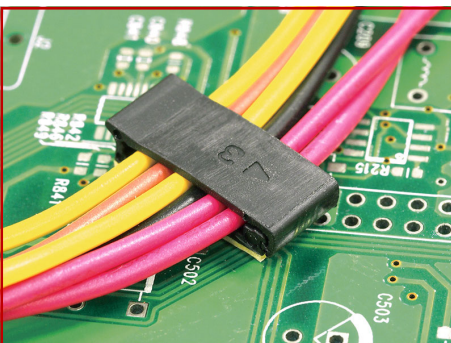

PART NO	B	H	PACKAGE
WS-T536	16.1	4.0	1000
WS-T898	17.0	8.0	1000

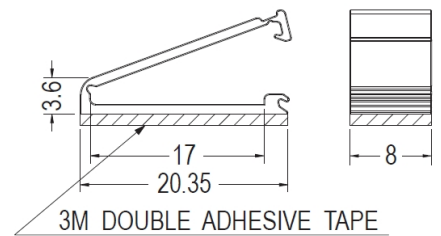

PART NO	PACKAGE
WS-T899	1000

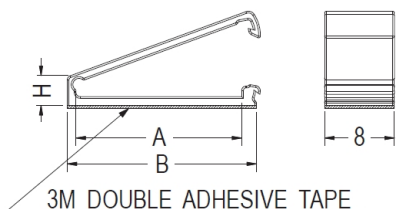

PART NO	A	B	H	PACKAGE
WS-T537	19.0	21.7	3.38	1000
WS-T538	18.5	21.85	4.87	1000

电线固定座 FLAT CABLE CLAMP 自粘式配线固定座 背胶式

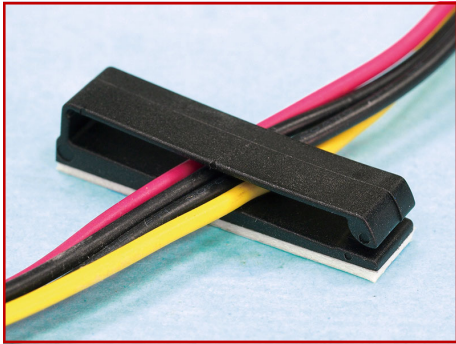

- ◆ MATERIAL : NYLON 66(UL)
- ◆ FLAME CLASS : 94V-2,94V-0
- ◆ COLOR : BLACK / NATURAL
- ◆ UNIT: mm

用途： 电线固定座,自粘式配线固定座背胶式，用于电子、计算机内部电线固定，装配容易，美观不脱落。

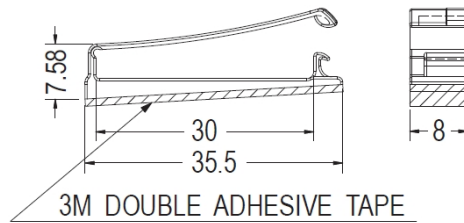

PART NO	PACKAGE
WS-T649	1000

电线固定座 CABLE CLAMP 自粘式配线固定座 背胶式



- ◆ MATERIAL : NYLON 66(UL)
- ◆ FLAME CLASS : 94V-2,94V-0
- ◆ COLOR : BLACK / NATURAL
- ◆ UNIT: mm

用途： 电线固定座,自粘式配线固定座背胶式，可快速拆卸，固定电线维修方便，不占空间。

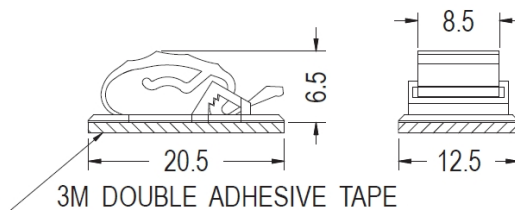

PART NO	PACKAGE
WS-T270	1000

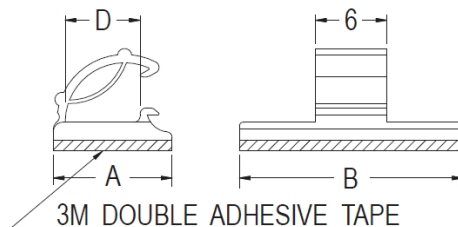
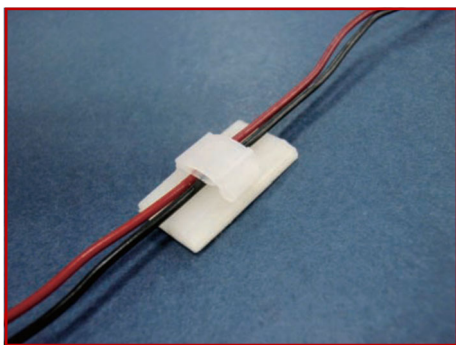

PART NO	A	B	D	PACKAGE
WS-T271	10.0	19.0	6.3	1000
WS-T272	10.0	11.0	6.3	1000
WS-T273	14.0	19.0	10.5	500
WS-T274	10.0	19.5	6.0	1000

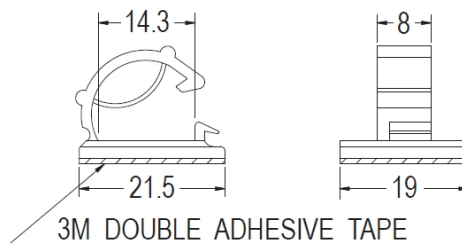
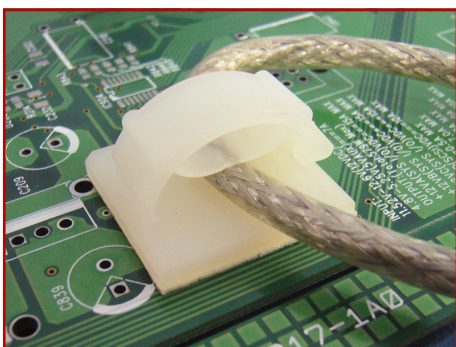

PART NO	PACKAGE
WS-T275	500

电线固定座 CABLE CLAMP 自粘式配线固定座 背胶式

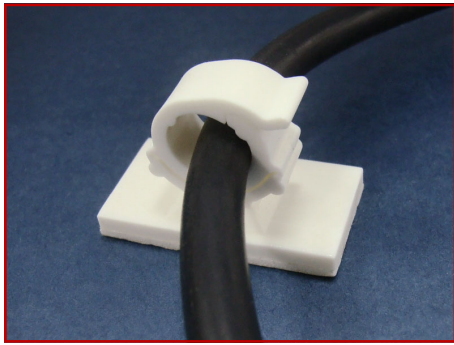

- ◆ MATERIAL : NYLON 66(UL)
- ◆ FLAME CLASS : 94V-2,94V-0
- ◆ COLOR : BLACK / NATURAL
- ◆ UNIT: mm

用途： 电线固定座,自粘式配线固定座，背胶式，可快速拆卸，固定电线维修方便，不占空间。

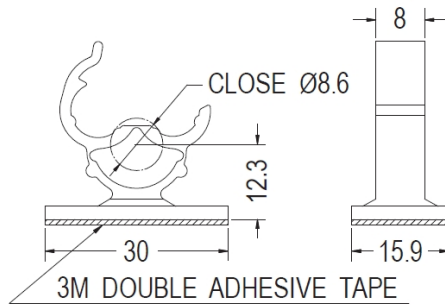

PART NO	PACKAGE
WS-T344	250

电线固定座

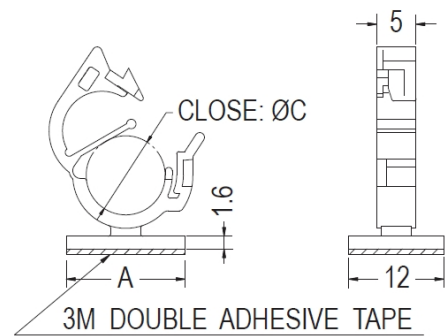

PART NO	A	C	PACKAGE
WS-T078	15.0	7.6	500
WS-T079	19.0	10.0	500
WS-T080	20.0	12.0	500



- ◆ MATERIAL : NYLON 66(UL)
- ◆ FLAME CLASS : 94V-2,94V-0
- ◆ COLOR : BLACK / NATURAL
- ◆ UNIT: mm

用途： 电线固定座,自粘式配线固定座，小型化，背胶式，可快速捆扎及解开电线。

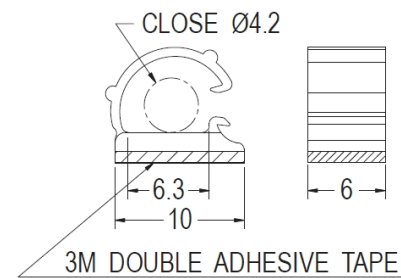

PART NO	PACKAGE
WS-T276	1000

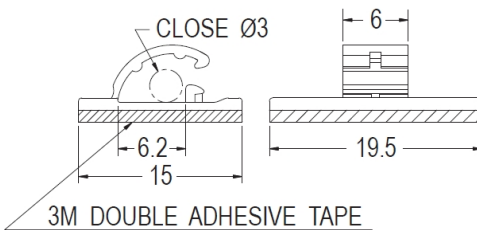
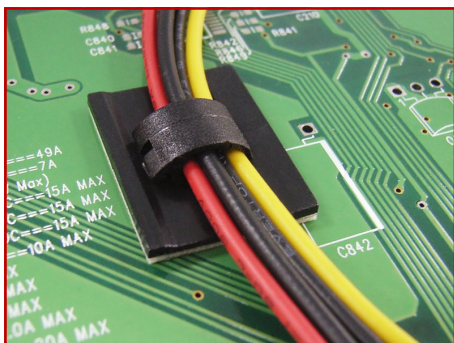

PART NO	PACKAGE
WS-T277	1000

电线固定座 CABLE CLAMP 自粘式配线固定座 背胶式

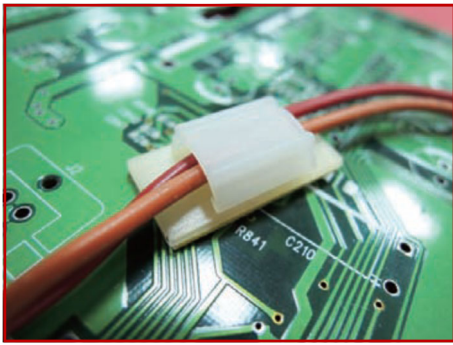

- ◆ MATERIAL : NYLON 66(UL)
- ◆ FLAME CLASS : 94V-2,94V-0
- ◆ COLOR : BLACK / NATURAL
- ◆ UNIT: mm

用途： 电线固定座,自粘式配线固定座
小型化, 背胶式, 可快速捆扎
及解开电线。

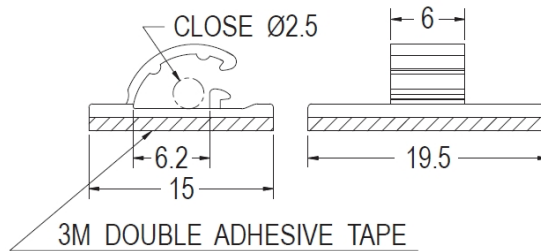

PART NO	PACKAGE
WS-T278	1000

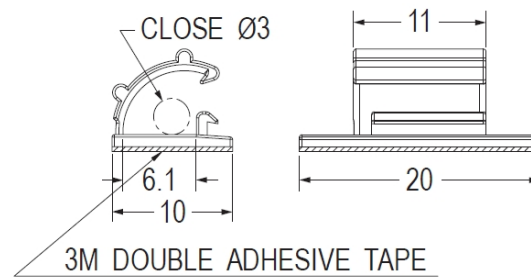
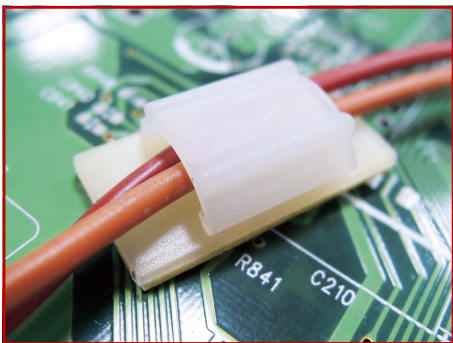

PART NO	PACKAGE
WS-T377	500

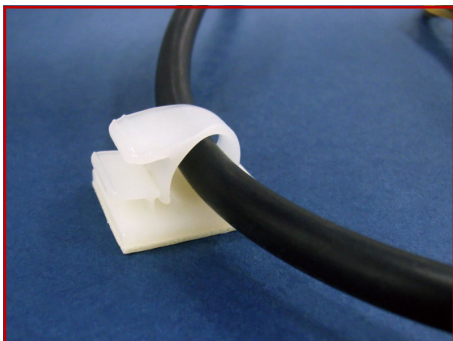

- ◆ MATERIAL : NYLON 66(UL)
- ◆ FLAME CLASS : 94V-2,94V-0
- ◆ COLOR : BLACK / NATURAL
- ◆ UNIT: mm

用途： 电线固定座,自粘式配线固定座
背胶式, 可快速拆卸, 固定电
线维修方便, 不占空间。

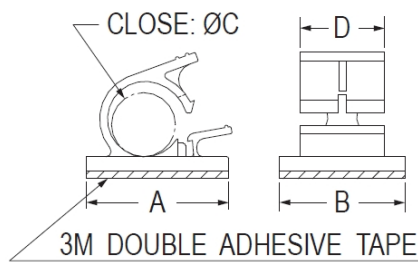

PART NO	A	B	C	D	PACKAGE
WS-T183	13.0	10.0	4.0	6.8	1000
WS-T184	15.0	13.0	6.0	9.0	1000
WS-T185	21.6	19.0	9.0	12.8	500
WS-T186	25.0	20.0	11.0	13.2	250
WS-T187	32.0	25.4	13.4	16.0	200
WS-T188	35.8	24.8	18.0	16.8	100
WS-T189	56.1	50.0	25.4	20.1	50
WS-T190	56.1	50.0	30.0	20.1	50
WS-T356	31.0	19.0	9.0	2.8	200
WS-T379	37.6	31.5	18.0	17.0	100

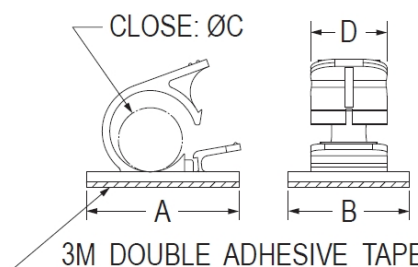

PART NO	A	B	C	D	PACKAGE
WS-T591	13.0	10.0	5.0	6.8	1000

电线固定座 CABLE CLAMP 自粘式配线固定座 背胶式

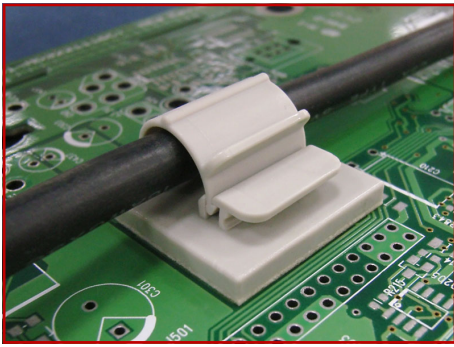

- ◆ MATERIAL : NYLON 66(UL)
- ◆ FLAME CLASS : 94V-2,94V-0
- ◆ COLOR : BLACK / NATURAL
- ◆ UNIT: mm

用途： 电线固定座,自粘式配线固定座，背胶式，可快速拆卸，固定电线维修方便，不占空间。

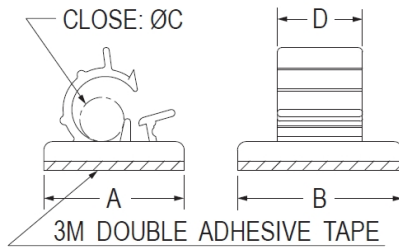

PART NO	A	B	C	D	PACKAGE
WS-T163	16.4	19.3	5.0	9.7	500
WS-T164	25.3	25.4	11.0	16.1	250
WS-T165	37.0	29.3	19.6	16.9	100
WS-T166	57.1	50.5	26.8	31.7	50
WS-T167	22.1	25.4	6.35	16.0	250
WS-T168	30.73	25.4	12.7	16.26	100

电线固定座

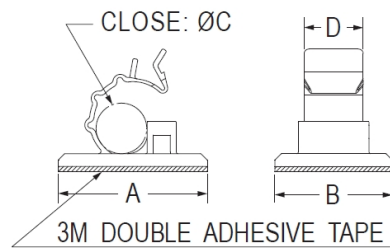

PART NO	A	B	C	D	PACKAGE
WS-T169	17.5	20.5	6.2	8.6	200
WS-T170	25.5	17.5	7.0	9.8	200
WS-T171	30.3	23.9	10.3	12.0	200
WS-T172	30.0	21.0	10.0	12.0	200
WS-T173	29.9	23.9	14.5	14.0	200
WS-T174	35.7	25.2	18.5	15.9	200

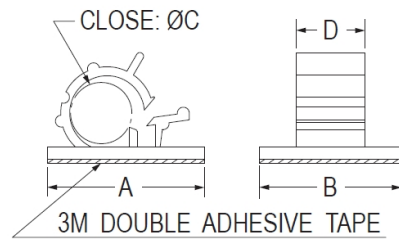

PART NO	A	B	C	D	PACKAGE
WS-T175	21.0	19.0	8.2	9.2	500
WS-T176	25.0	20.0	9.0	12.0	250
WS-T177	25.0	19.7	10.6	12.1	250
WS-T178	29.0	20.0	12.6	14.0	250
WS-T179	29.6	19.5	12.8	14.8	250
WS-T180	21.6	17.0	10.4	12.0	250
WS-T378	19.0	19.0	6.8	8.8	500

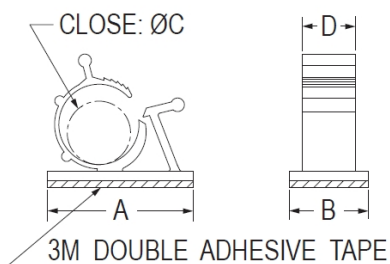
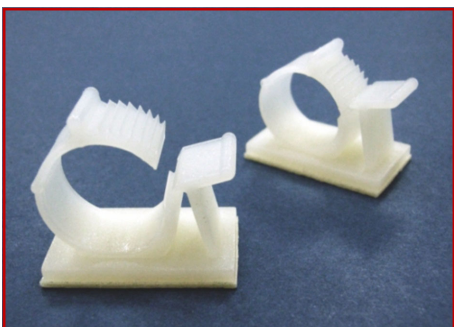

PART NO	A	B	C	D	PACKAGE
WS-T018	24.8	18.8	7.9~10.3	10.2	250
WS-T019	25.4	15.0	11.0~13.3	10.0	250
WS-T020	30.2	15.0	11.9~14.3	10.0	250
WS-T021	34.4	18.8	14.7~19.1	12.7	100
WS-T022	36.0	19.0	18.0~22.0	12.7	100
WS-T023	39.8	19.8	22.0~26.5	13.0	100
WS-T592	31.8	19.1	11.9~14.3	10.2	250

电线固定座 CABLE CLAMP 自粘式配线固定座 背胶式



- ◆ MATERIAL : NYLON 66(UL)
- ◆ FLAME CLASS : 94V-2,94V-0
- ◆ COLOR : BLACK / NATURAL
- ◆ UNIT: mm

用途： 电线固定座,自粘式配线固定座
背胶式, 可快速拆卸, 固定电
线, 维修方便, 不占空间。

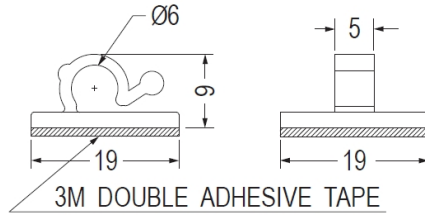

PART NO	PACKAGE
WS-T477	1000

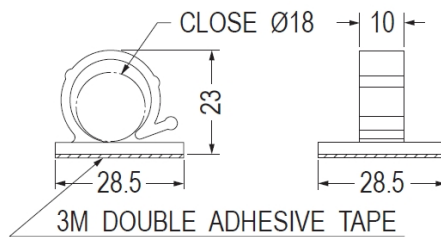
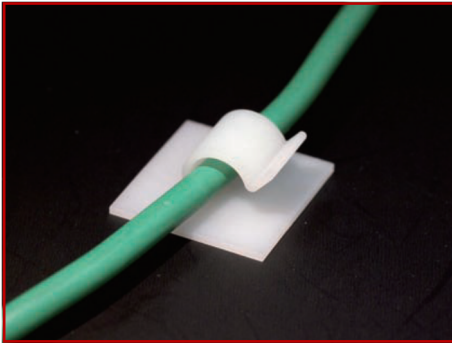

PART NO	PACKAGE
WS-T340	500

电线固定座 WIRE CLIP 自粘式配线固定座 背胶式

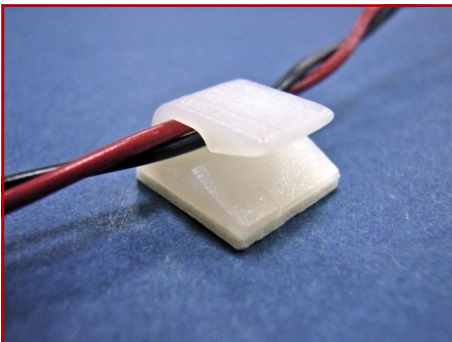

- ◆ MATERIAL : NYLON 66(UL)
- ◆ FLAME CLASS : 94V-2,94V-0
- ◆ COLOR : BLACK / NATURAL
- ◆ UNIT: mm

用途： 电线固定座,自粘式配线固定座
背胶式, 固定电线于机器中,
整齐美观。

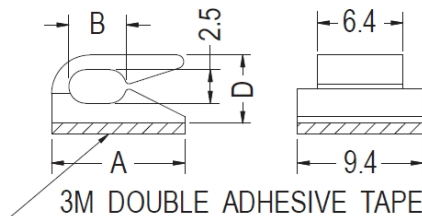

PART NO	A	B	D	PACKAGE
WS-T268	10.0	4.3	5.1	1000
WS-T269	12.0	6.3	5.5	1000

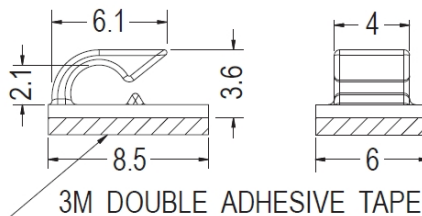

PART NO	PACKAGE
WS-T650	1000

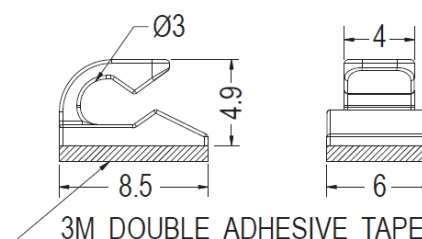
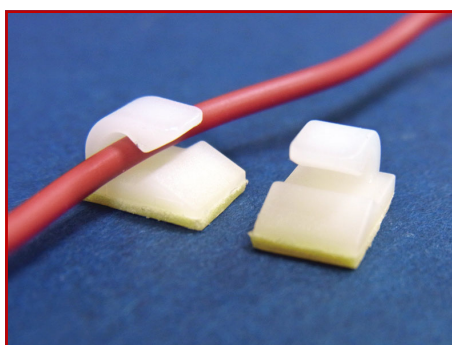

PART NO	PACKAGE
WS-T236	1000

电线固定座 WIRE CLIP 自粘式配线固定座 背胶式

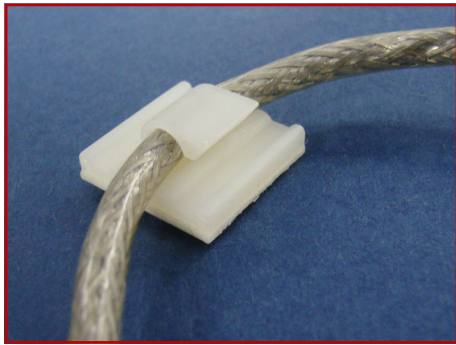

- ◆ MATERIAL : NYLON 66(UL)
- ◆ FLAME CLASS : 94V-2,94V-0
- ◆ COLOR : BLACK / NATURAL
- ◆ UNIT: mm

用途： 电线固定座,自粘式配线固定座，背胶式，固定电线于机器中，整齐美观。

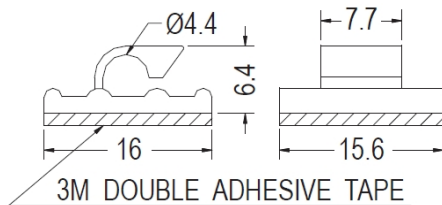

PART NO	PACKAGE
WS-T267	1000

电线固定座

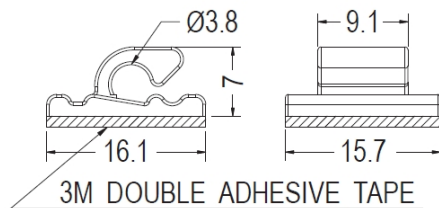
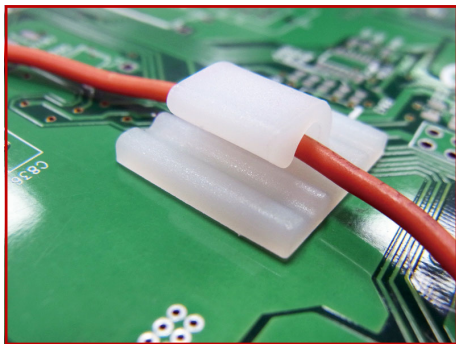

PART NO	PACKAGE
WS-T265	1000

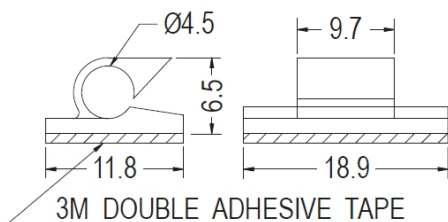
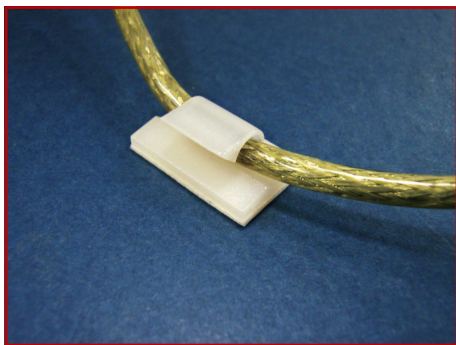

PART NO	PACKAGE
WS-T281	1000

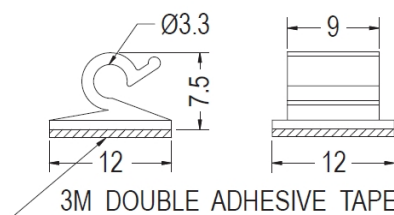

PART NO	PACKAGE
WS-T282	1000

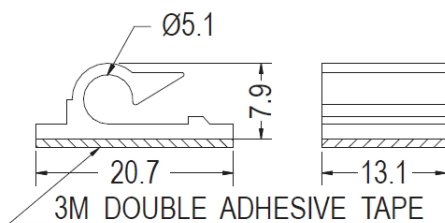
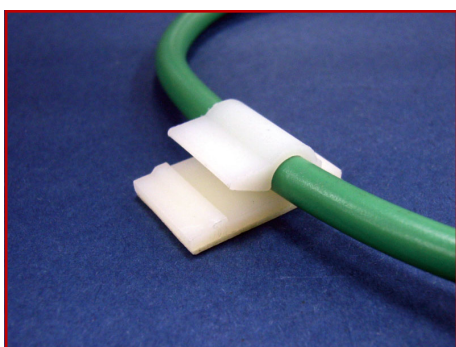

PART NO	PACKAGE
WS-T279	500

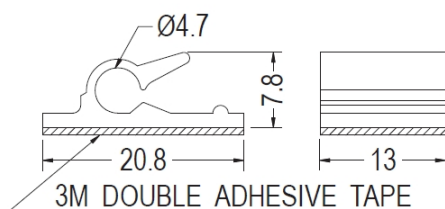
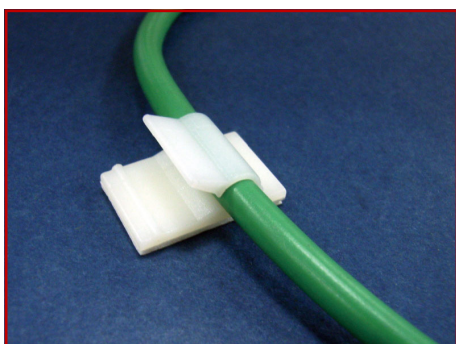

PART NO	PACKAGE
WS-T283	1000

电线固定座 WIRE CLIP 自粘式配线固定座 背胶式

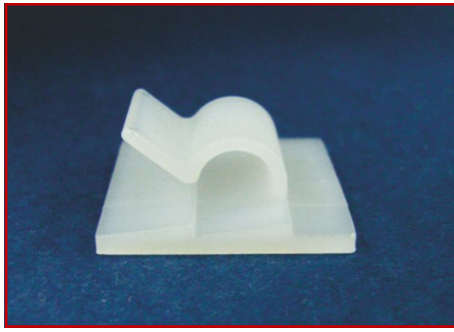

- ◆ MATERIAL : NYLON 66(UL)
- ◆ FLAME CLASS : 94V-2,94V-0
- ◆ COLOR : BLACK / NATURAL
- ◆ UNIT: mm

用途： 电线固定座,自粘式配线固定座
背胶式，固定电线于机器中，
整齐美观。

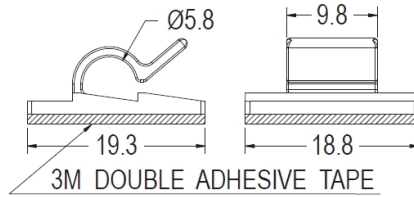

PART NO	PACKAGE
WS-T284	500

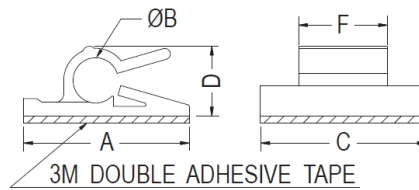
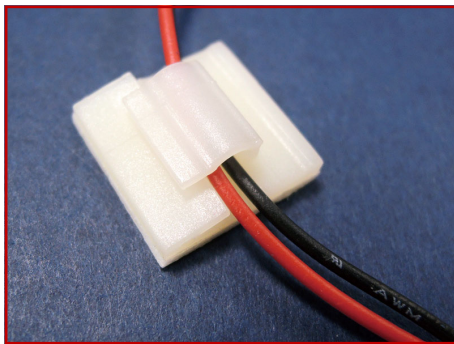

PART NO	A	B	C	D	F	PACKAGE
WS-T303	15.9	4.0	15.9	5.7	9.7	500
WS-T304	19.0	5.2	19.0	8.0	10.2	500
WS-T305	19.0	6.0	20.0	9.9	10.0	500

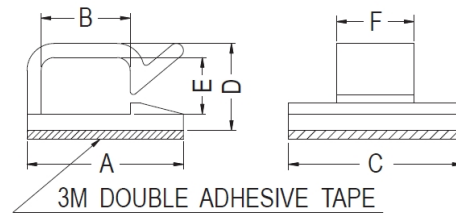
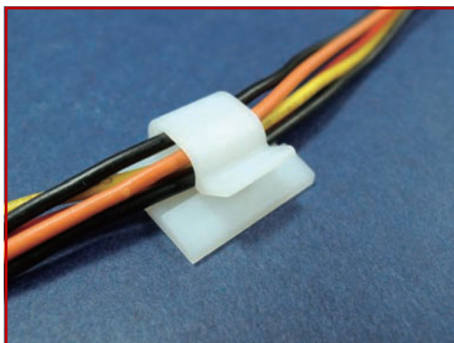

PART NO	A	B	C	D	E	F	PACKAGE
WS-T287	14.4	8.2	16.0	8.0	5.2	7.1	1000
WS-T288	16.8	10.2	16.0	9.5	6.7	7.0	500
WS-T290	20.8	13.6	19.0	11.3	8.2	9.0	500
WS-T291	15.4	9.9	16.0	7.3	4.7	7.0	1000
WS-T682	20.1	15.8	16.0	9.3	6.5	9.0	500
WS-T683	22.7	18.0	20.0	8.7	6.0	10.0	500

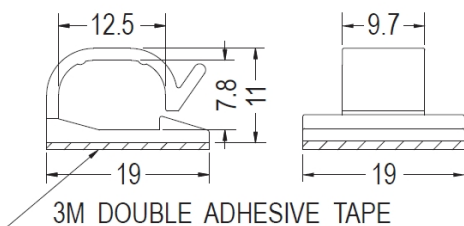

PART NO	PACKAGE
WS-T289	500

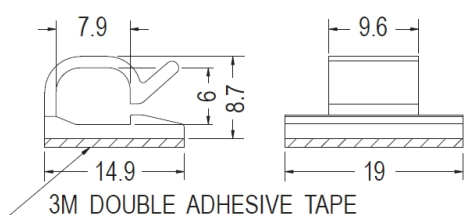

PART NO	PACKAGE
WS-T478	1000

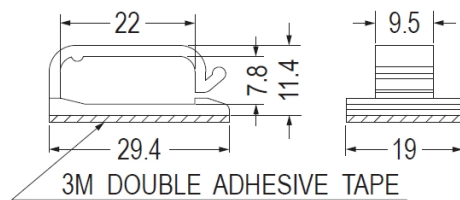

PART NO	PACKAGE
WS-T900	1000

电线固定座

电线固定座 WIRE CLIP 自粘式配线固定座 背胶式

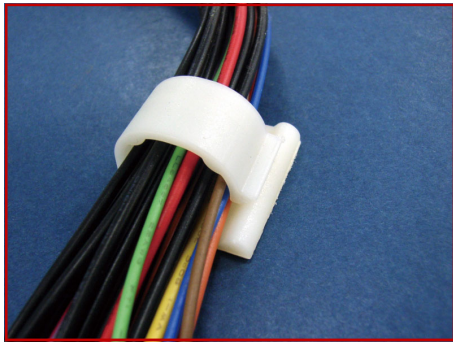

- ◆ MATERIAL : NYLON 66(UL)
- ◆ FLAME CLASS : 94V-2,94V-0
- ◆ COLOR : BLACK / NATURAL
- ◆ UNIT: mm

用途： 电线固定座,自粘式配线固定座，背胶式，可快速拆卸，固定电线，维修方便，不占空间。

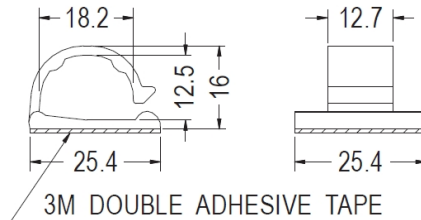

PART NO	PACKAGE
WS-T280	1000

电线固定座

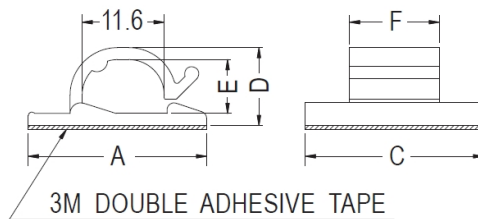

PART NO	A	B	C	D	F	PACKAGE
WS-T292	25.4	15.5	11.3	7.8	6.5	500
WS-T293	25.2	25.2	11.0	7.6	12.7	500

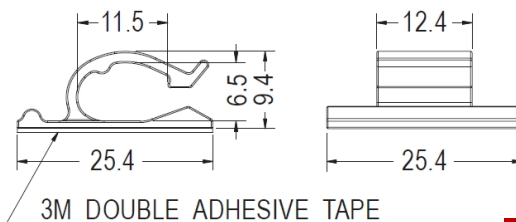
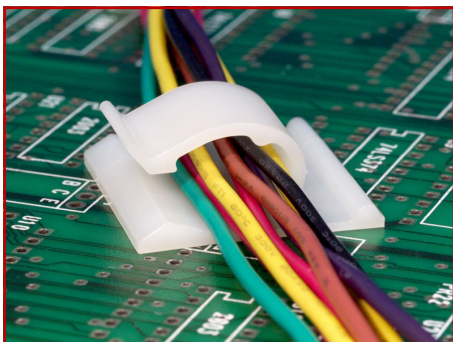

PART NO	PACKAGE
WS-T651	500

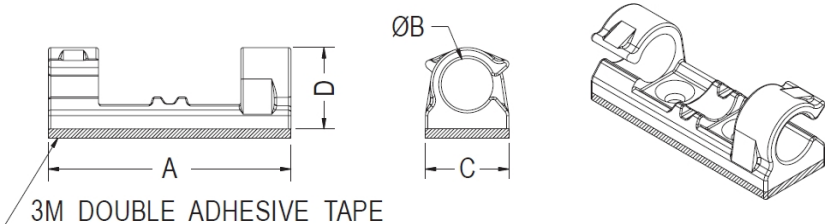
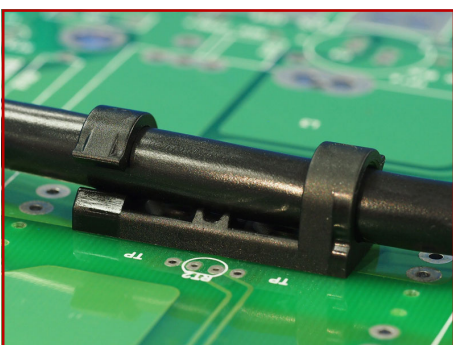

PART NO	A	B	C	D	PACKAGE
WS-T652	29.0	6.2	10.0	9.7	500
WS-T653	33.0	9.0	13.0	12.7	500

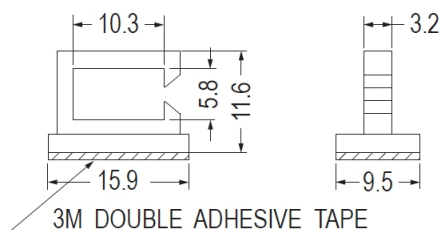
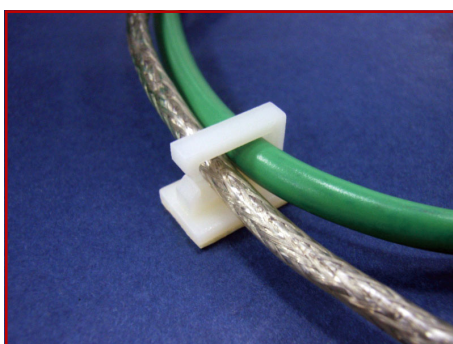

PART NO	PACKAGE
WS-T345	1000

电线固定座 WIRE SADDLE 自粘式配线固定座 背胶式

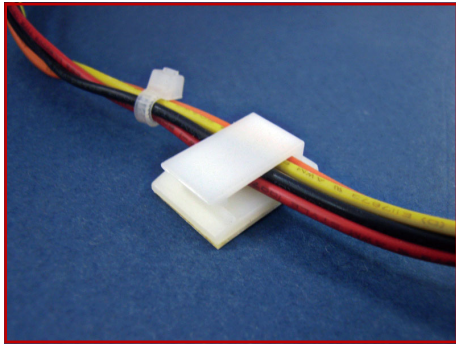

- ◆ MATERIAL : NYLON 66(UL)
- ◆ FLAME CLASS : 94V-2,94V-0
- ◆ COLOR : BLACK / NATURAL
- ◆ UNIT: mm

用途： 电线固定座,自粘式配线固定座
背胶式, 可快速拆卸, 固定电
线, 维修方便, 不占空间。

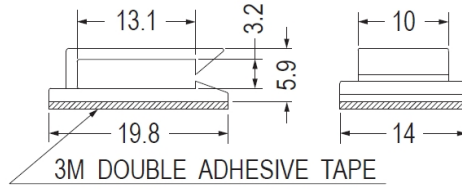

PART NO	PACKAGE
WS-T232	1000

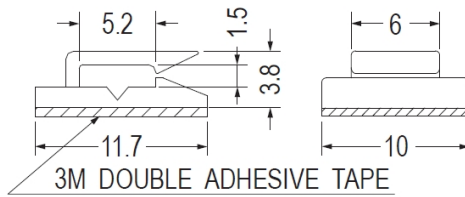
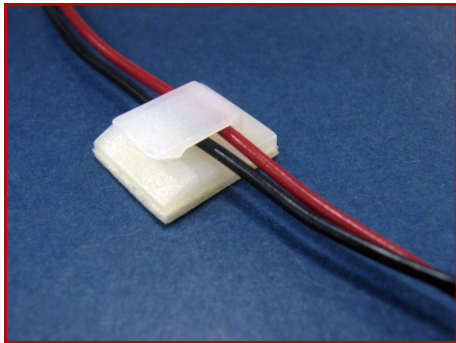

PART NO	PACKAGE
WS-T294	1000

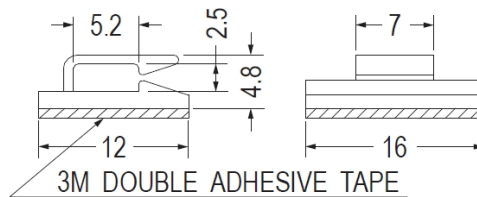
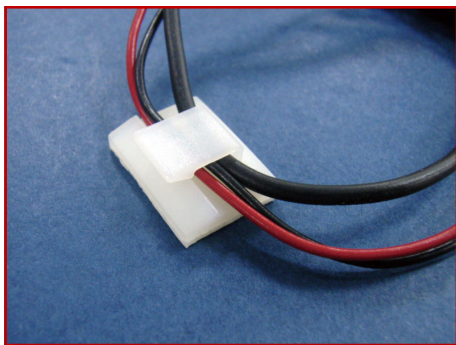

PART NO	PACKAGE
WS-T266	1000

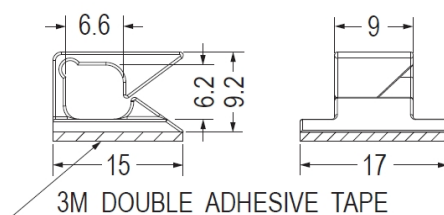
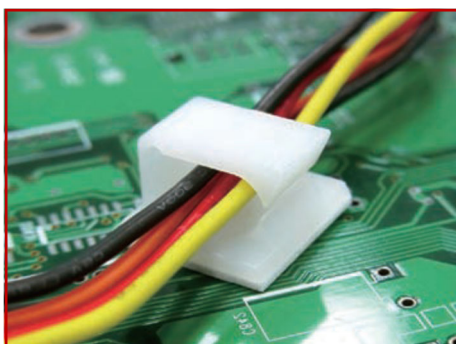

PART NO	PACKAGE
WS-T383	1000

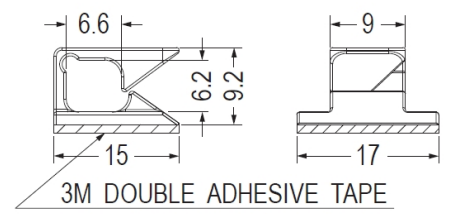

PART NO	PACKAGE
WS-T593	1000

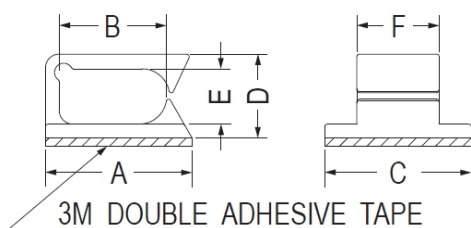

PART NO	A	B	C	D	E	F	PACKAGE
WS-T341	12.0	6.2	12.1	6.3	3.6	9.1	1000
WS-T342	16.0	11.7	16.0	9.1	6.0	9.0	1000
WS-T381	14.1	7.6	15.8	9.1	6.1	9.0	1000
WS-T382	14.0	10.5	12.1	6.25	3.5	10.0	1000

电线固定座

电线固定座 WIRE CLIP 自粘式配线固定座 背胶式

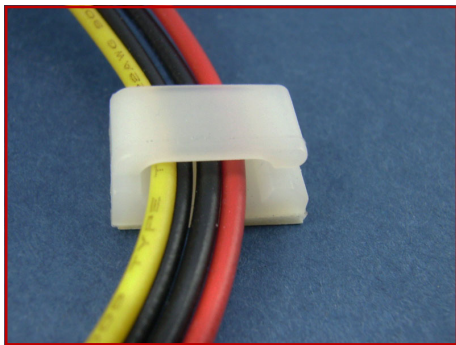

- ◆ MATERIAL : NYLON 66(UL)
- ◆ FLAME CLASS : 94V-2,94V-0
- ◆ COLOR : BLACK / NATURAL
- ◆ UNIT: mm

用途： 电线固定座,自粘式配线固定座，背胶式，可快速拆卸，固定电线，维修方便，不占空间。

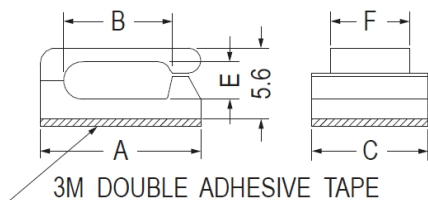

PART NO	A	B	C	E	F	PACKAGE
WS-T223	13.0	8.5	9.2	3.0	6.3	1000
WS-T224	16.0	11.5	13.0	2.9	9.0	1000

电线固定座

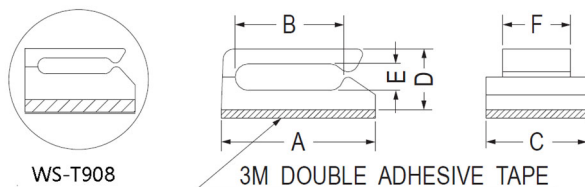
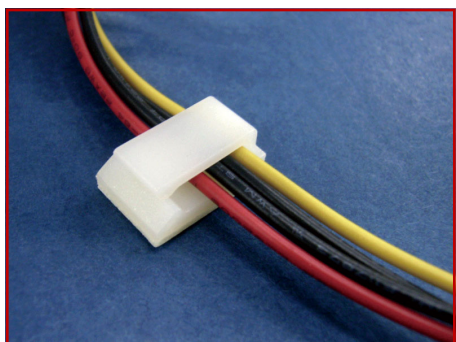

PART NO	A	B	C	D	E	F	PACKAGE
WS-T229	12.5	8.4	9.5	5.2	2.8	6.5	1000
WS-T231	14.5	10.2	9.5	5.7	2.5	6.4	1000
WS-T384	12.7	8.1	12.7	5.0	2.5	6.4	1000
WS-T385	9.8	6.65	9.5	3.85	1.4	6.4	1000
WS-T908	9.7	6.45	9.5	4.5	1.4	6.4	1000

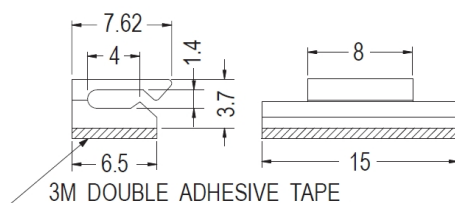
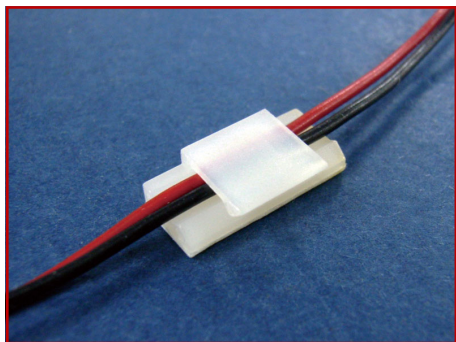

PART NO	PACKAGE
WS-T226	1000

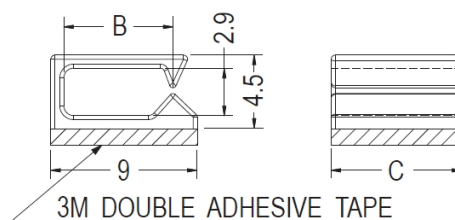
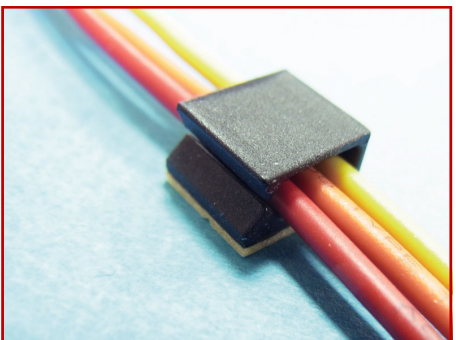

PART NO	B	C	PACKAGE
WS-T233	6.7	8.0	1000
WS-T386	6.73	4.0	1000

电线固定座 WIRE SADDLE 自粘式配线固定座 背胶式

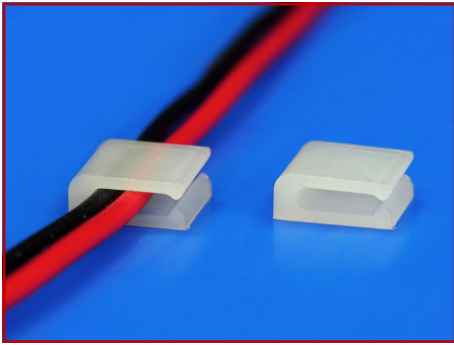

- ◆ MATERIAL : NYLON 66(UL)
- ◆ FLAME CLASS : 94V-2,94V-0
- ◆ COLOR : BLACK / NATURAL
- ◆ UNIT: mm

用途： 电线固定座,自粘式配线固定座
背胶式,可快速拆卸,固定电
线,维修方便,不占空间。

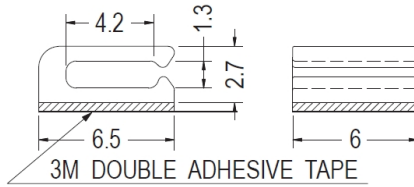

PART NO	PACKAGE
WS-T654	1000

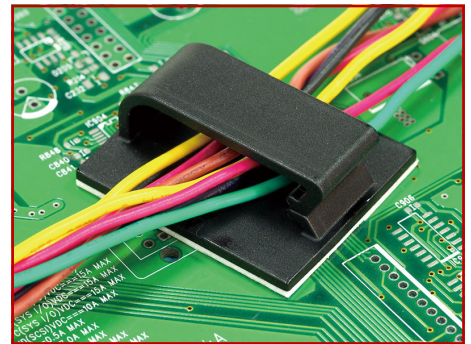
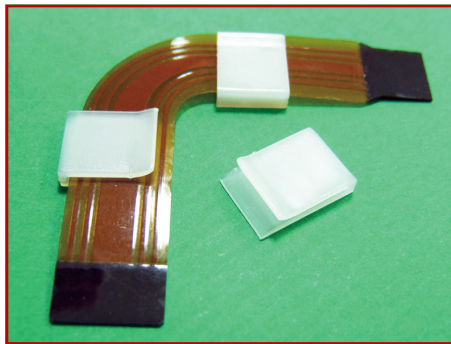
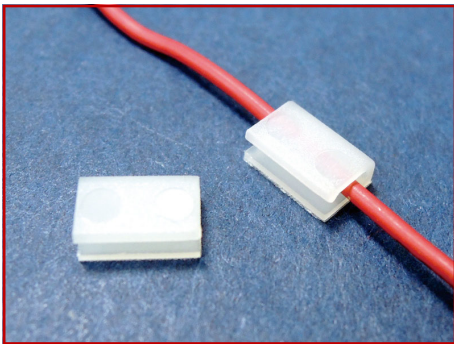

电线固定座

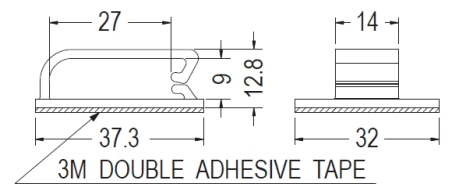
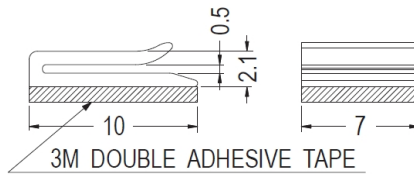
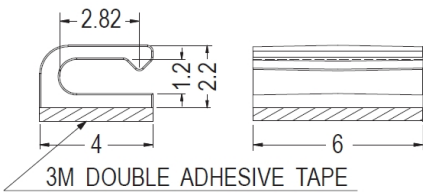

PART NO	PACKAGE
WS-T479	1000

PART NO	PACKAGE
WS-T234	1000

PART NO	PACKAGE
WS-T357	250

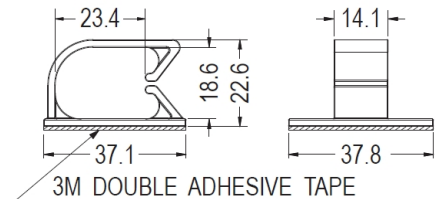
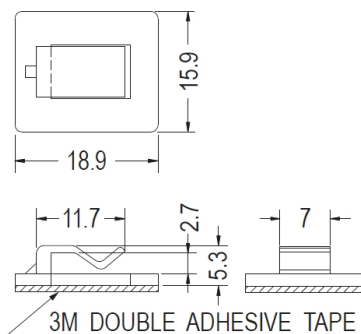
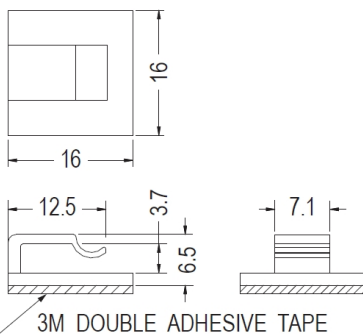
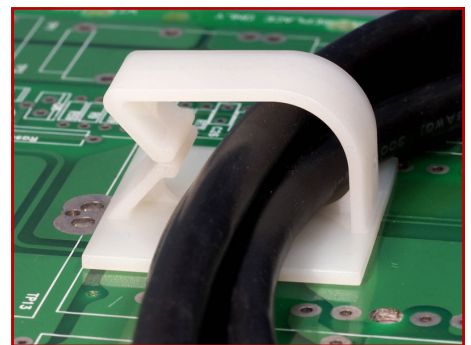
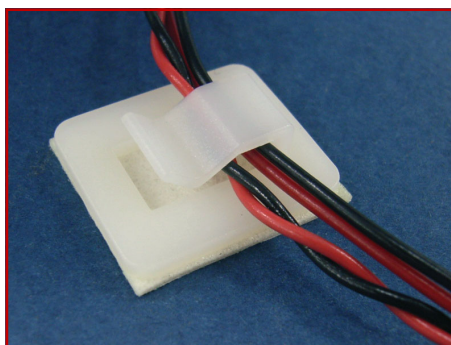
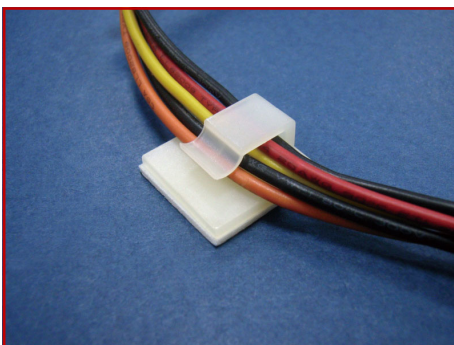

PART NO	PACKAGE
WS-T301	500

PART NO	PACKAGE
WS-T302	500

PART NO	PACKAGE
WS-T655	100

电线固定座 WIRE CLIP 自粘式配线固定座 背胶式

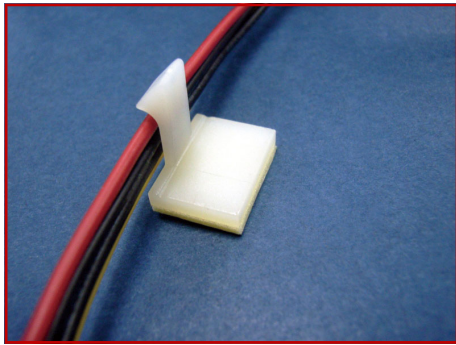

- ◆ MATERIAL : NYLON 66(UL)
- ◆ FLAME CLASS : 94V-2,94V-0
- ◆ COLOR : BLACK / NATURAL
- ◆ UNIT: mm

用途： 电线固定座,自粘式配线固定座，背胶式，可快速拆卸，固定电线，维修方便，不占空间。

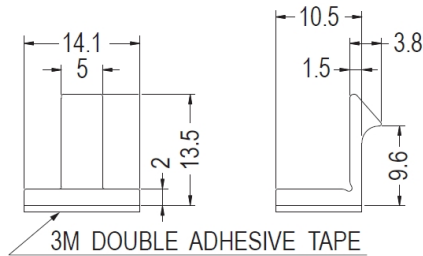

PART NO	PACKAGE
WS-T295	500

电线固定座

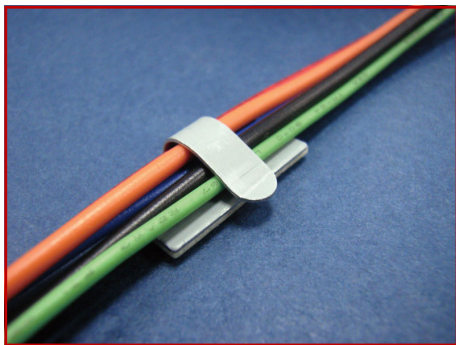

- ◆ MATERIAL : STEEL
- ◆ UNIT: mm

用途： 电线固定座,自粘式配线固定座，背胶式，可快速捆扎电线安装容易，经特殊处理，不刮手，不会刮伤电线。

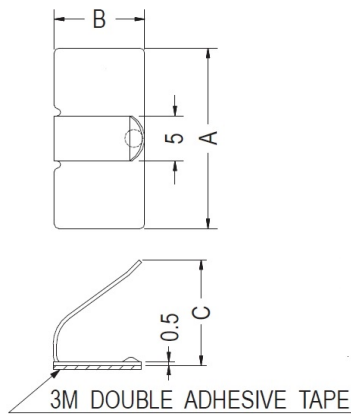

PART NO	A	B	C	PACKAGE
WS-T296	20.0	10.0	11.6	1000
WS-T297	25.0	15.0	17.1	1000

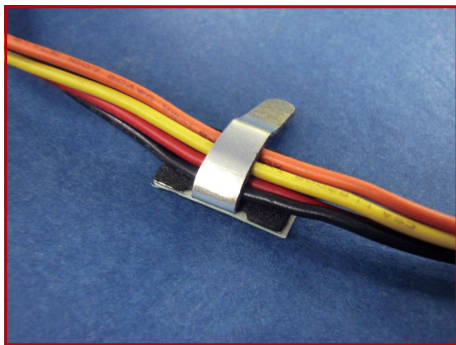

- ◆ MATERIAL : SPTE
- ◆ UNIT: mm

用途： 电线固定座,自粘式配线固定座，背胶式，可快速捆扎电线安装容易，经特殊处理，不刮手，不会刮伤电线。

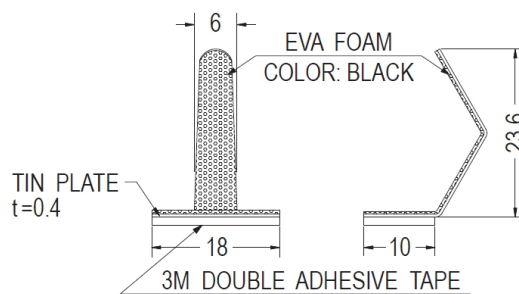

PART NO	PACKAGE
WS-T298	1000

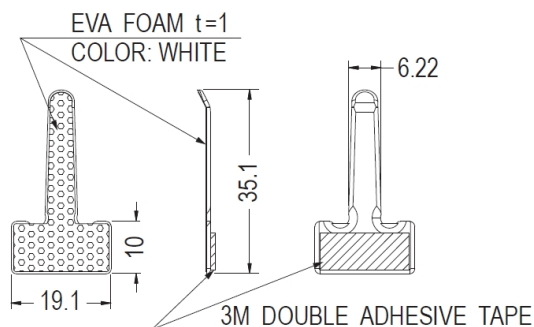
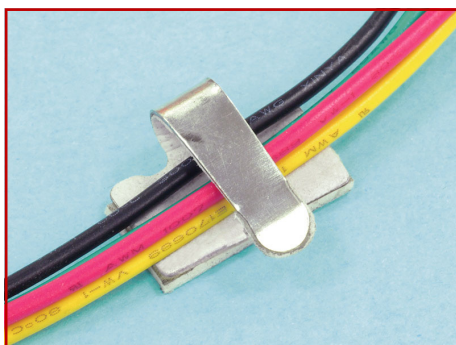

PART NO	PACKAGE
WS-T480	1000

电线固定座 WIRE SADDLE 自粘式配线固定座 背胶式

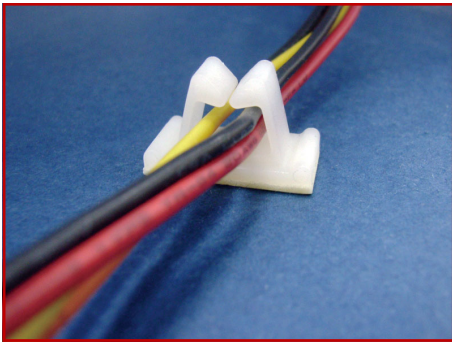

- ◆ MATERIAL : NYLON 66(UL)
- ◆ FLAME CLASS : 94V-2,94V-0
- ◆ COLOR : BLACK / NATURAL
- ◆ UNIT: mm

用途： 电线固定座,自粘式配线固定座
背胶式, 可快速拆卸, 固定电
线, 维修方便, 不占空间。

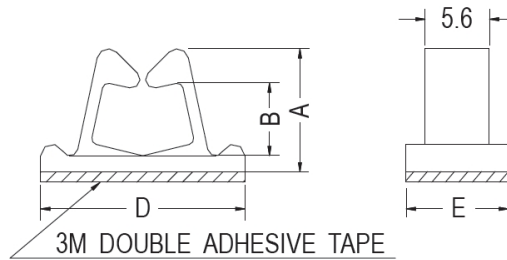

PART NO	A	B	D	E	PACKAGE
WS-T354	10.7	6.3	17.8	8.9	1000
WS-T355	10.8	6.5	25.5	12.6	1000

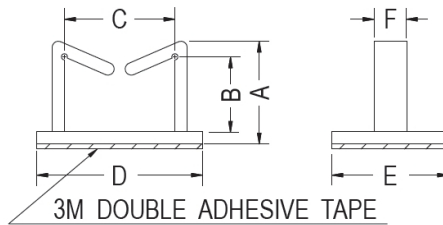
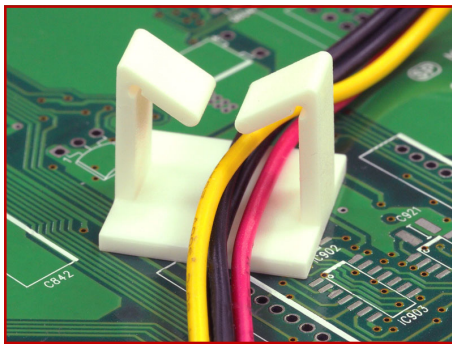

PART NO	A	B	C	D	E	F	PACKAGE
WS-T349	17.2	12.2	11.5	21.0	19.0	5.3	500
WS-T350	16.7	12.16	18.0	27.0	19.0	5.3	500
WS-T351	26.0	21.2	11.5	21.0	19.0	5.3	500
WS-T352	17.0	12.17	11.5	17.01	12.5	5.3	500

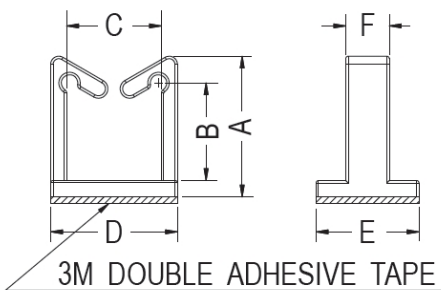

PART NO	A	B	C	D	E	F	PACKAGE
WS-T353	17.1	11.5	11.5	15.4	12.5	5.3	500
WS-T387	17.5	12.7	16.5	20.5	19.0	7.0	500

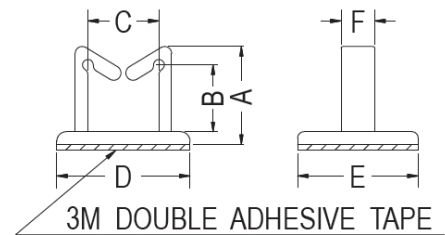

PART NO	PACKAGE
WS-T390	500

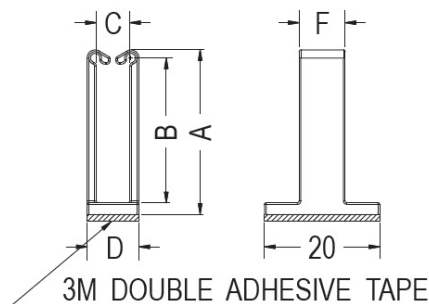

PART NO	A	B	C	D	F	PACKAGE
WS-T475	28.5	25.1	5.8	9.0	8.0	500
WS-T605	19.2	15.45	6.8	10.0	5.0	500

电线固定座 WIRE SADDLE 自粘式配线固定座 背胶式

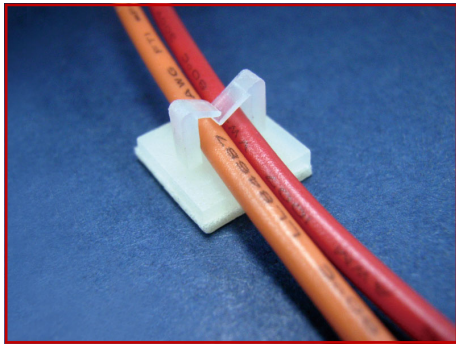

- ◆ MATERIAL : NYLON 66(UL)
- ◆ FLAME CLASS : 94V-2,94V-0
- ◆ COLOR : BLACK / NATURAL
- ◆ UNIT: mm

用途： 电线固定座,自粘式配线固定座，超小型，背胶式，可快速固定及解开电线。

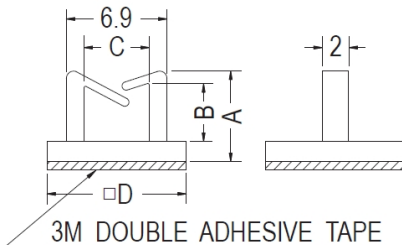

PART NO	A	B	C	D	PACKAGE
WS-T320	6.5	3.8	4.5	9.6	1000
WS-T321	6.2	4.23	4.3	9.6	1000
WS-T388	6.2	4.23	4.3	8.5	1000
WS-T389	6.5	4.3	4.5	9.5	1000

电线固定座

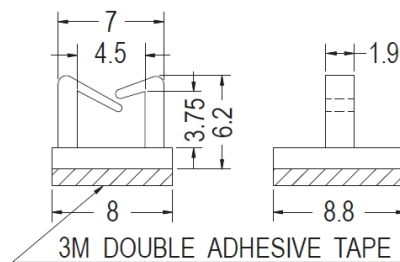
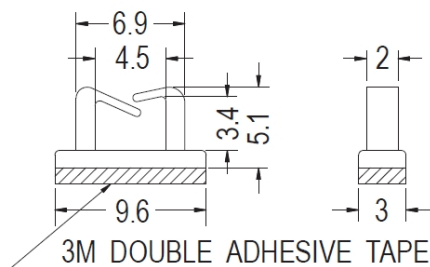
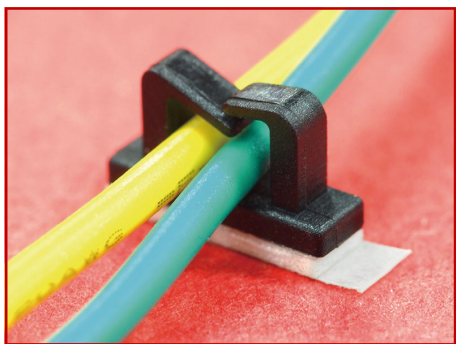

PART NO	PACKAGE
WS-T391	1000

PART NO	PACKAGE
WS-T686	1000

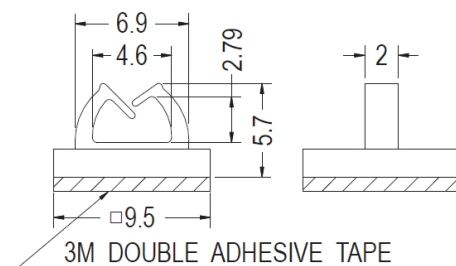
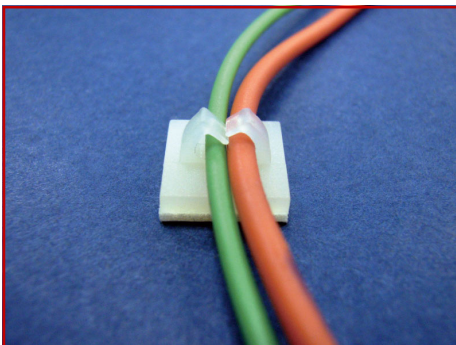

PART NO	PACKAGE
WS-T322	1000

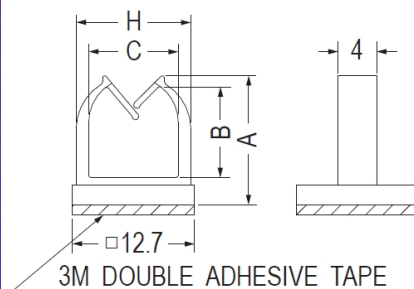
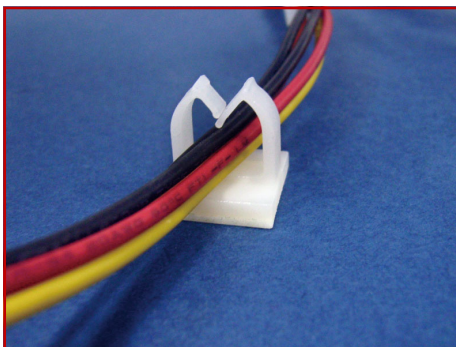

PART NO	A	B	C	H	PACKAGE
WS-T323	13.4	9.46	9.3	11.9	1000
WS-T594	9.3	5.5	6.6	9.0	1000
WS-T595	11.2	7.3	8.0	10.8	1000
WS-T596	15.0	11.1	9.2	12.0	1000

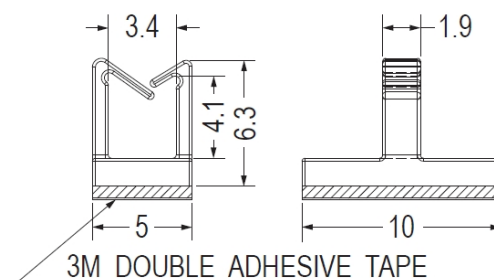
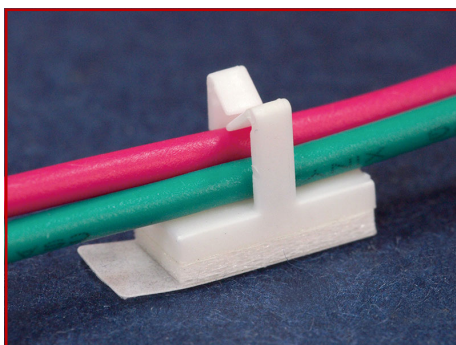

PART NO	PACKAGE
WS-T618	1000

电线固定座 WIRE SADDLE 自粘式配线固定座 背胶式

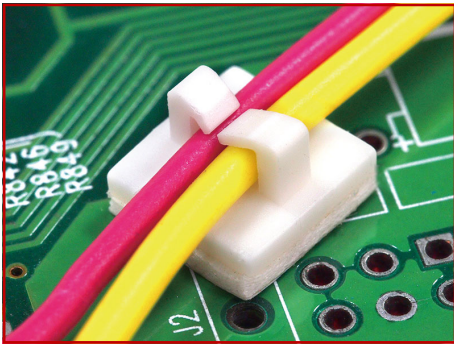

- ◆ MATERIAL : NYLON 66(UL)
- ◆ FLAME CLASS : 94V-2,94V-0
- ◆ COLOR : BLACK / NATURAL
- ◆ UNIT: mm

用途： 电线固定座,自粘式配线固定座，超小型，背胶式，可快速固定及解开电线。

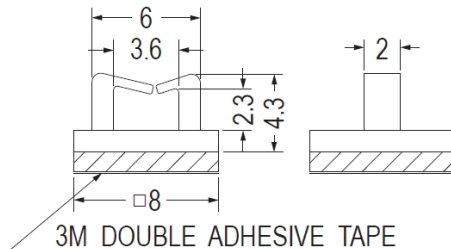

PART NO	PACKAGE
WS-T585	1000

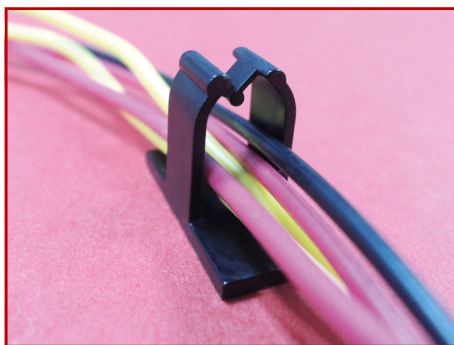

- ◆ MATERIAL : NYLON 66(UL)
- ◆ FLAME CLASS : 94V-2,94V-0
- ◆ COLOR : BLACK / NATURAL
- ◆ UNIT: mm

用途： 电线固定座,自粘式配线固定座背胶式，可快速拆卸，固定电线，维修方便，不占空间。

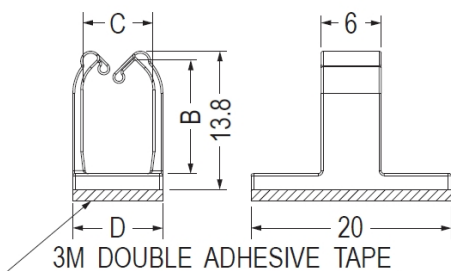

PART NO	B	C	D	PACKAGE
WS-T393	11.31	7.0	9.0	1000
WS-T565	11.18	6.0	8.0	1000

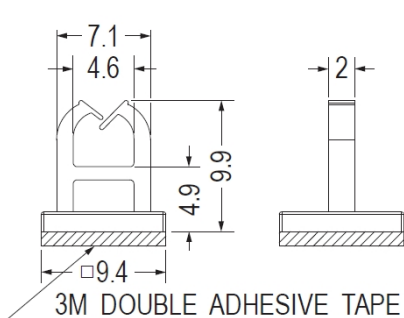
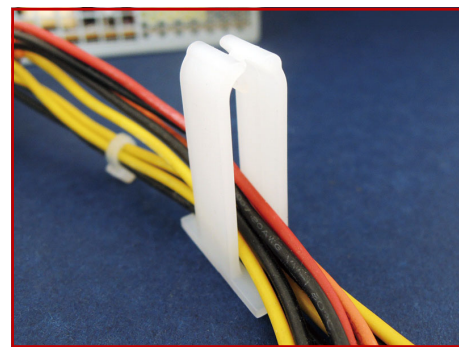
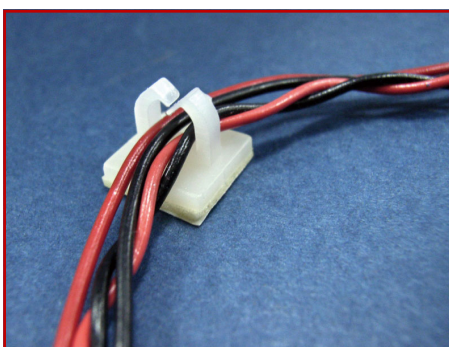
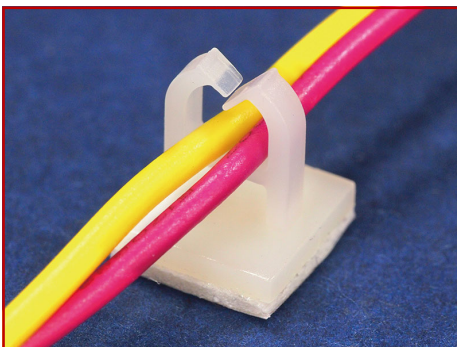

PART NO	PACKAGE
WS-T358	1000

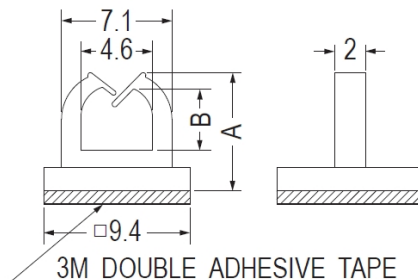

PART NO	A	B	PACKAGE
WS-T324	7.6	3.94	1000
WS-T392	9.3	5.64	1000

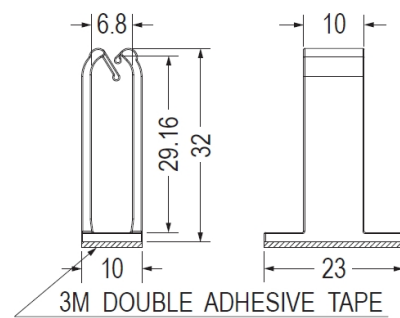

PART NO	PACKAGE
WS-T394	500

电线固定座 WIRE SADDLE 自粘式配线固定座 背胶式

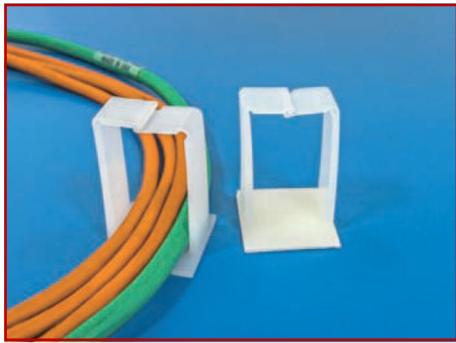

- ◆ MATERIAL : NYLON 66(UL)
- ◆ FLAME CLASS : 94V-2,94V-0
- ◆ COLOR : BLACK / NATURAL
- ◆ UNIT: mm

用途： 电线固定座,自粘式配线固定座，背胶式，可快速拆卸，固定电线，维修方便，不占空间。

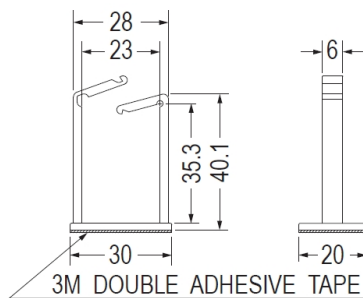

PART NO	PACKAGE
WS-T339	200

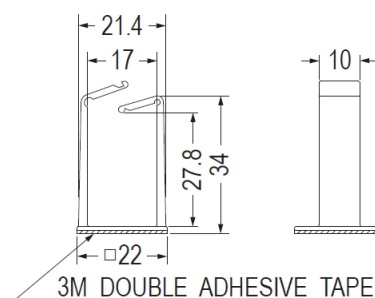

PART NO	PACKAGE
WS-T687	200

电线固定座

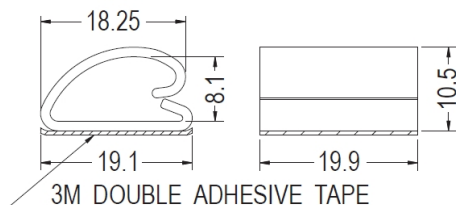
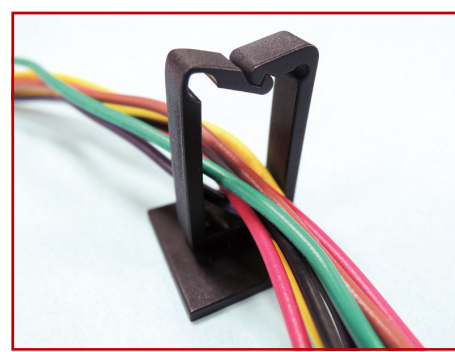

PART NO	PACKAGE
WS-T360	1000

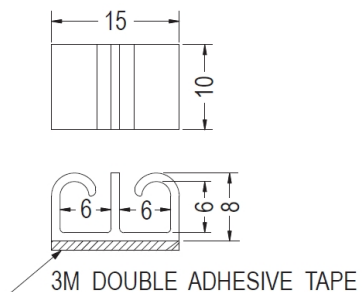

PART NO	PACKAGE
WS-T325	1000

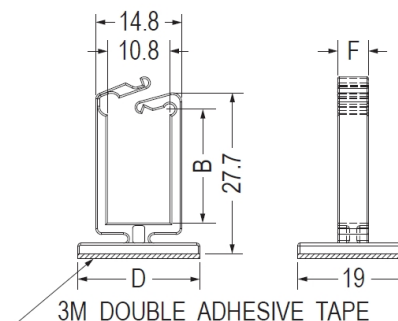

PART NO	B	D	F	PACKAGE
WS-T395	19.57	21.0	5.3	200
WS-T598	19.6	16.0	9.3	200

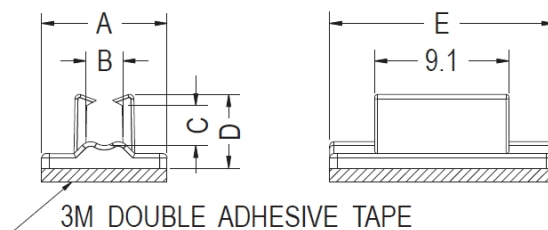
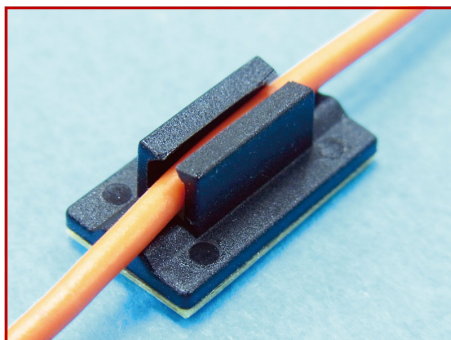

PART NO	A	B	C	D	E	PACKAGE
WS-T401	8.5	2.5	2.7	5.0	15.2	500
WS-T402	9.0	3.6	4.0	6.5	16.0	500

电线固定座 WIRE MOUNT 自粘式配线固定座 背胶式

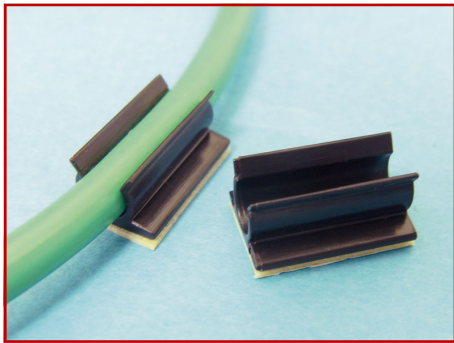

- ◆ MATERIAL : ABS
- ◆ COLOR : BLACK
- ◆ UNIT: mm

用途： 电线固定座,自粘式配线固定座，超小型，背胶式，可快速固定及解开电线。

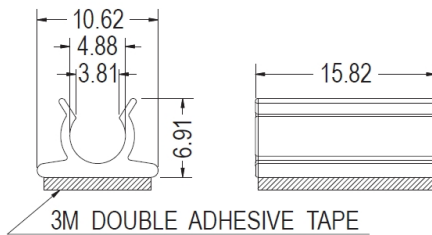

PART NO	PACKAGE
WS-T260	500

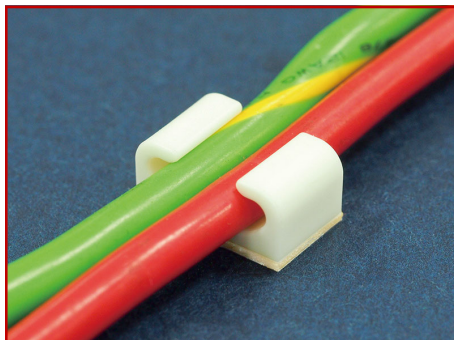

- ◆ MATERIAL : NYLON 66(UL)
- ◆ FLAME CLASS : 94V-2,94V-0
- ◆ COLOR : BLACK / NATURAL
- ◆ UNIT: mm

用途： 电线固定座,自粘式配线固定座背胶式，可快速拆卸，固定电线，维修方便，不占空间。

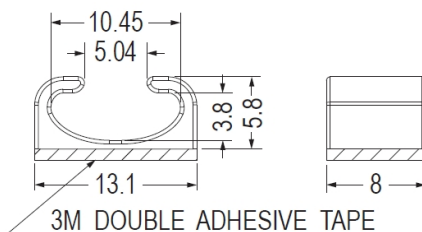

PART NO	PACKAGE
WS-T541	1000

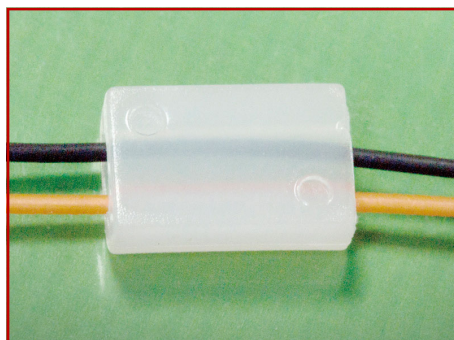

- ◆ MATERIAL : NYLON 66(UL)
- ◆ FLAME CLASS : 94V-2,94V-0
- ◆ COLOR : BLACK / NATURAL
- ◆ UNIT: mm

用途： 电线固定座,自粘式配线固定座背胶式，用于电子、计算机内部电线固定，装配容易，美观不脱落。

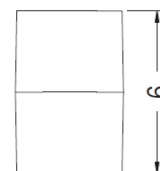
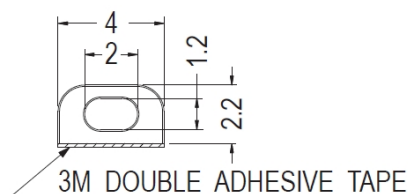

PART NO	PACKAGE
WS-T584	1000



- ◆ MATERIAL : NYLON 66(UL)
- ◆ FLAME CLASS : 94V-2,94V-0
- ◆ COLOR : BLACK / NATURAL
- ◆ UNIT: mm

用途： 电线固定座,自粘式配线固定座背胶式，用于电子、计算机内部电线固定，装配容易，美观不脱落。

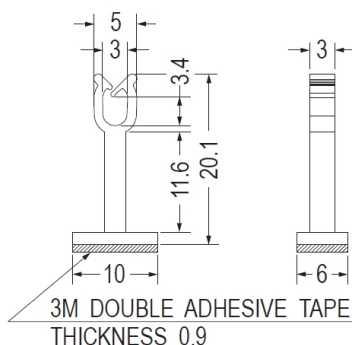

PART NO	PACKAGE
WS-T586	1000

电线固定座 WIRE MOUNT 自粘式配线固定座 背胶式

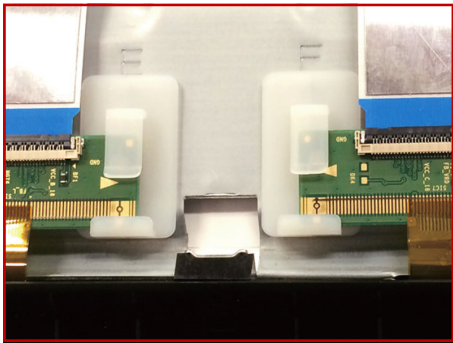

- ◆ MATERIAL : NYLON 66(UL)
- ◆ FLAME CLASS : 94V-2,94V-0
- ◆ COLOR : BLACK / NATURAL
- ◆ UNIT: mm

用途： 电线固定座,自粘式配线固定座，背胶式，可快速拆卸，固定电线，维修方便，不占空间。

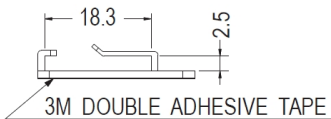
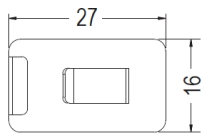

PART NO	PACKAGE
WS-T504	1000

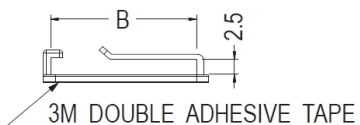
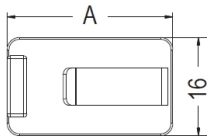

PART NO	B	D	PACKAGE
WS-T502	27.0	23.8	1000
WS-T564	31.9	28.7	1000

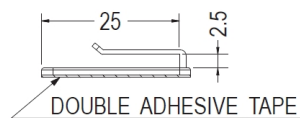
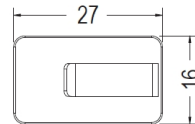

PART NO	PACKAGE
WS-T503	1000

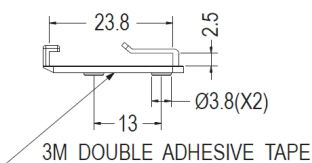
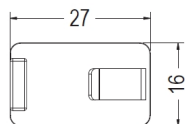

PART NO	PACKAGE
WS-T582	1000

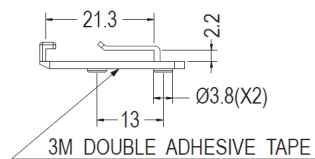
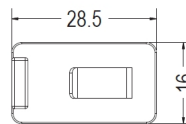

PART NO	PACKAGE
WS-T583	1000

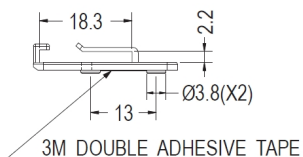
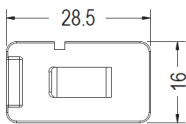
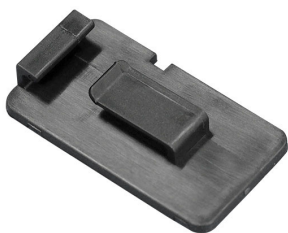

PART NO	PACKAGE
WS-T656	1000

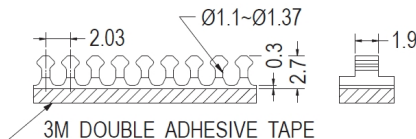
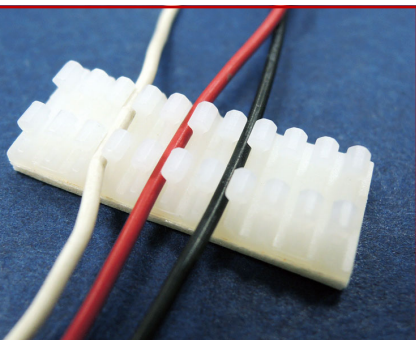

PART NO	PACKAGE
WS-T418	500

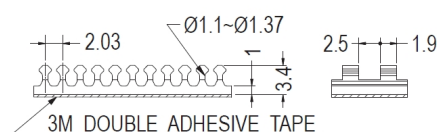
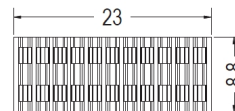

PART NO	PACKAGE
WS-T419	200

电线固定座 WIRE MOUNT 自粘式配线固定座 背胶式

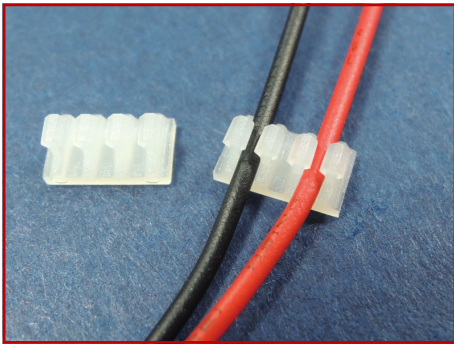

- ◆ MATERIAL : NYLON 66(UL)
- ◆ FLAME CLASS : 94V-2,94V-0
- ◆ COLOR : BLACK / NATURAL
- ◆ UNIT: mm

用途： 电线固定座,自粘式配线固定座，背胶式，可快速拆卸，固定电线，维修方便，不占空间。

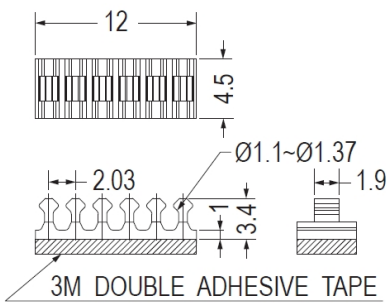

PART NO	PACKAGE
WS-T572	500

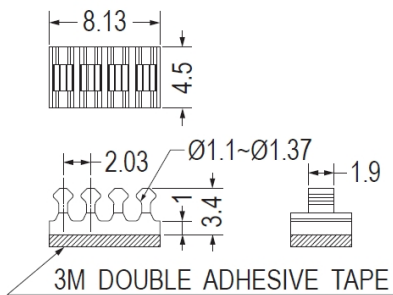

PART NO	PACKAGE
WS-T484	500

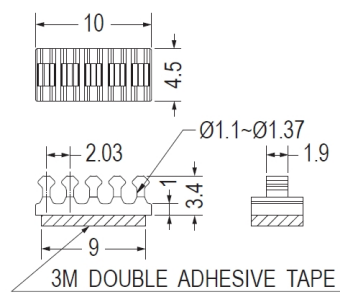

PART NO	PACKAGE
WS-T485	500

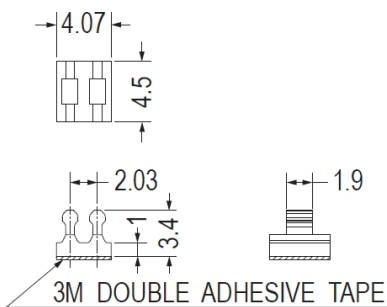
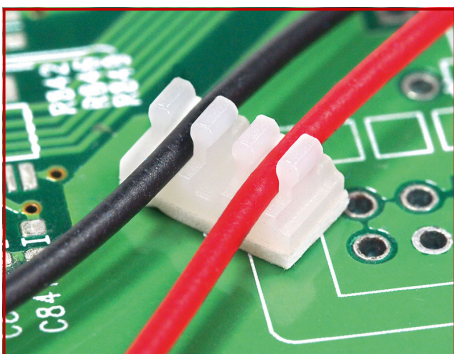

PART NO	PACKAGE
WS-T692	500

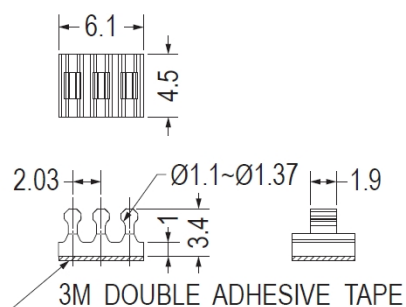

PART NO	PACKAGE
WS-T569	500

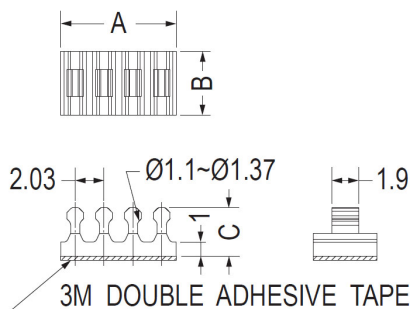

PART NO	A	B	C	PACKAGE
WS-T570	8.13	4.5	3.4	500
WS-T909	8.10	4.4	3.6	500

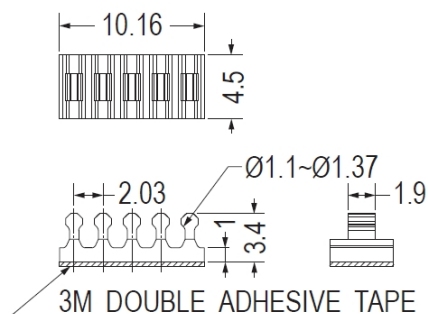

PART NO	PACKAGE
WS-T571	500

电线固定座

电线固定座 WIRE MOUNT 自粘式配线固定座 背胶式

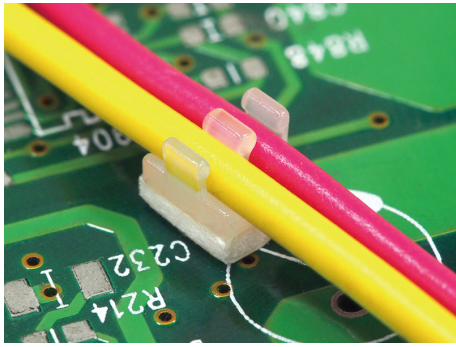

- ◆ MATERIAL : NYLON 66(UL)
- ◆ FLAME CLASS : 94V-2,94V-0
- ◆ COLOR : BLACK / NATURAL
- ◆ UNIT: mm

用途： 电线固定座,自粘式配线固定座，背胶式，可快速拆卸，固定电线，维修方便，不占空间。

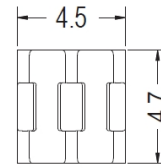
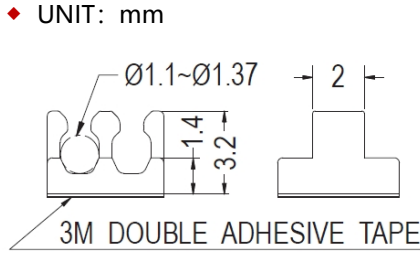

PART NO	PACKAGE
WS-T581	1000

电线固定座

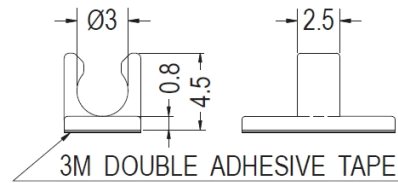
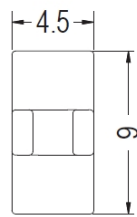
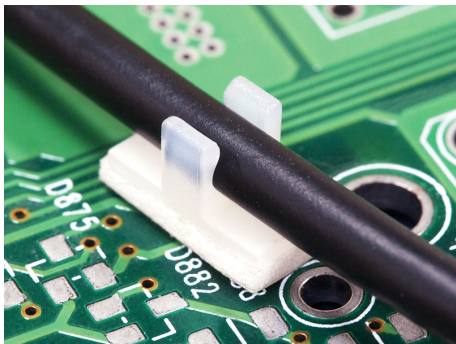

PART NO	PACKAGE
WS-T580	1000

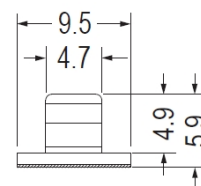
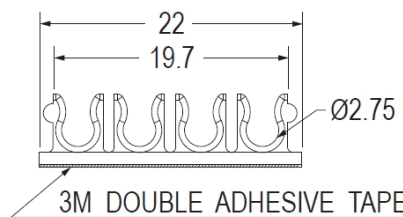
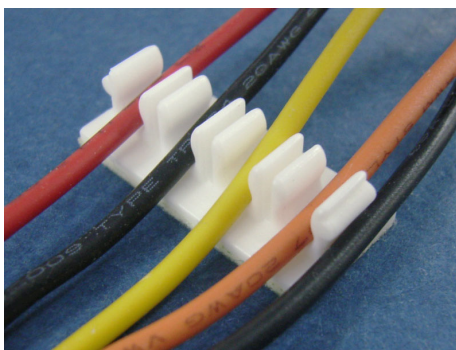

PART NO	PACKAGE
WS-T202	500

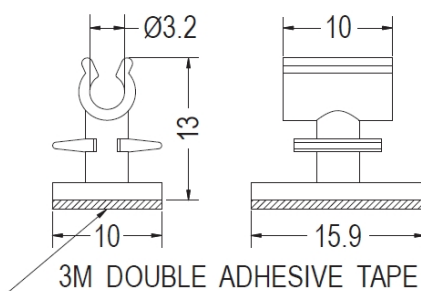

PART NO	PACKAGE
WS-T258	500

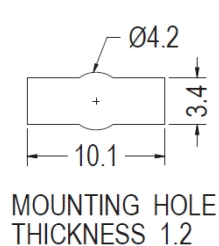
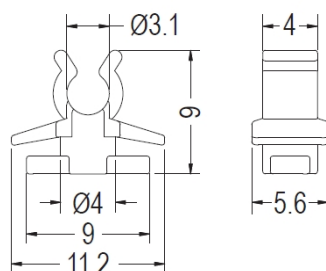

PART NO	PACKAGE
WS-T259	500

电线固定座 WIRE CLIP 自粘式配线固定座 背胶式

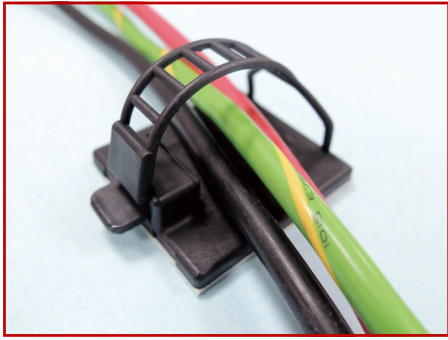

- ◆ MATERIAL : NYLON 66(UL)
- ◆ FLAME CLASS : 94V-2,94V-0
- ◆ COLOR : BLACK / NATURAL
- ◆ UNIT: mm

用途： 电线固定座,自粘式配线固定座，背胶式，可快速拆卸，固定电线，维修方便，不占空间。

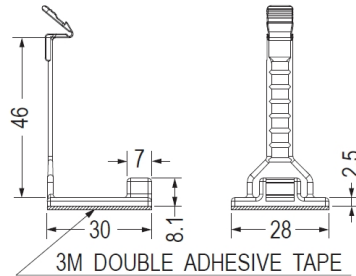

PART NO	PACKAGE
WS-T398	200

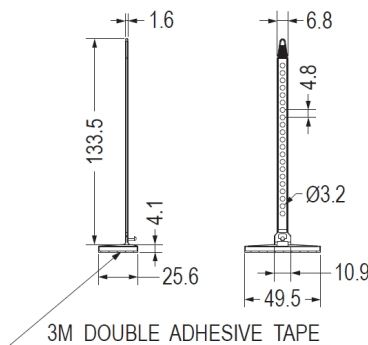

PART NO	PACKAGE
WS-T109	200

电线固定座 WIRE SADDLE 自粘式配线固定座 背胶式

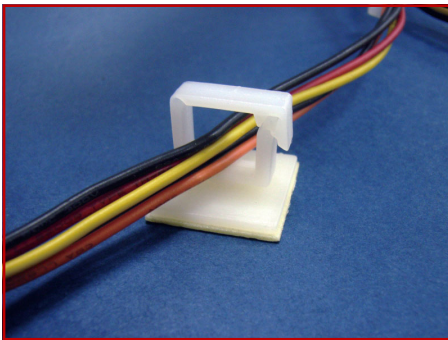

- ◆ MATERIAL : NYLON 66(UL)
- ◆ FLAME CLASS : 94V-2,94V-0
- ◆ COLOR : BLACK / NATURAL
- ◆ UNIT: mm

用途： 电线固定座,自粘式配线固定座，背胶式，可快速捆扎及解开电线。

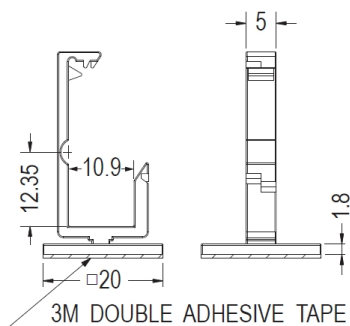

PART NO	PACKAGE
WS-T326	500

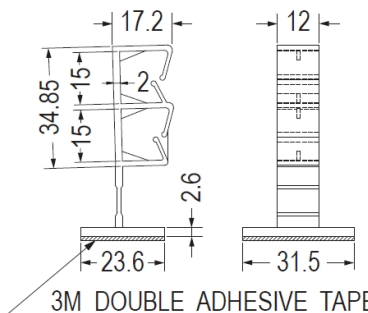
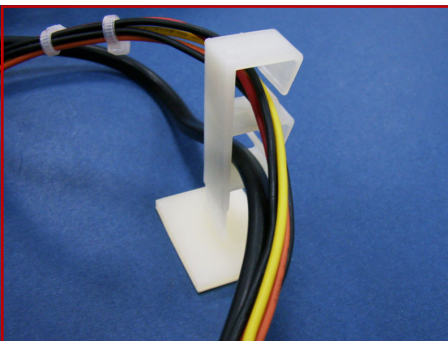

PART NO	PACKAGE
WS-T261	50

电线固定座 WIRE SADDLE 自粘式配线固定座 背胶式

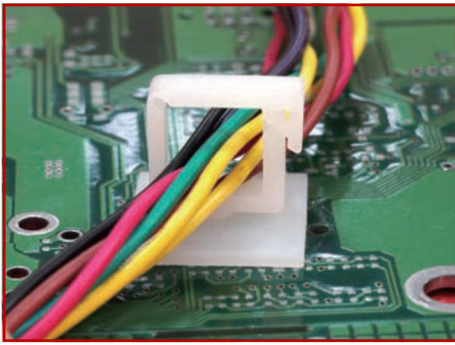

- ◆ MATERIAL : NYLON 66(UL)
- ◆ FLAME CLASS : 94V-2,94V-0
- ◆ COLOR : BLACK / NATURAL
- ◆ UNIT: mm

用途： 电线固定座,自粘式配线固定座，背胶式，可快速捆扎及解开电线。

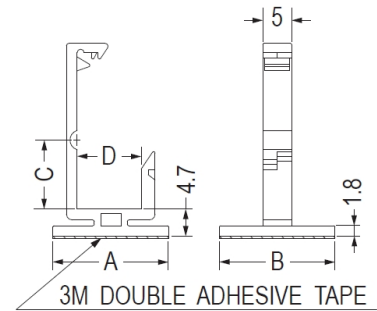
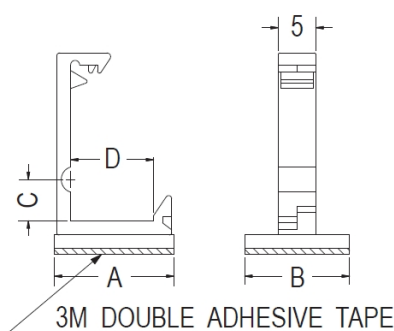

PART NO	A	B	C	D	PACKAGE
WS-T331	16.0	14.0	5.5	11.1	500
WS-T399	13.0	12.0	6.0	8.1	500

PART NO	A	B	C	D	PACKAGE
WS-T327	20.0	20.0	6.7	11.1	500
WS-T328	20.0	20.0	11.9	11.1	500
WS-T329	20.0	20.0	15.7	15.7	250
WS-T330	15.0	14.0	8.7	10.75	500
WS-T400	16.0	12.0	8.7	10.75	500

电线固定座 WIRE CLIP 自粘式配线固定座 背胶式

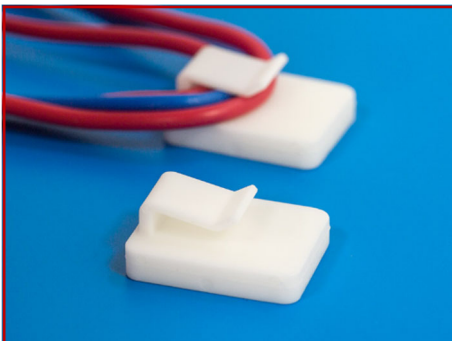

- ◆ MATERIAL : NYLON 66(UL)
- ◆ FLAME CLASS : 94V-2,94V-0
- ◆ COLOR : BLACK / NATURAL
- ◆ UNIT: mm

用途： 电线固定座,自粘式配线固定座，背胶式，可快速拆卸，固定电线，维修方便，不占空间。

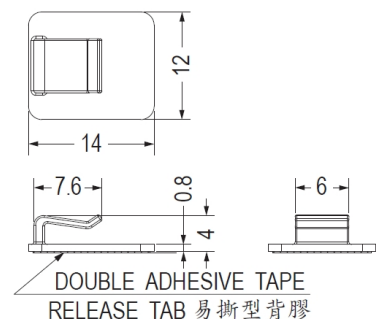
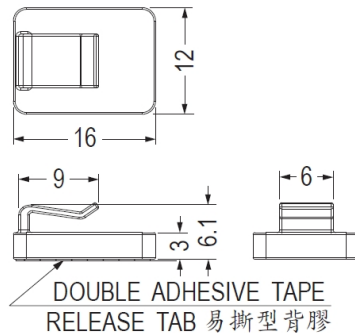
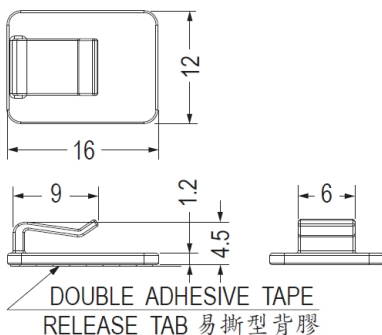

PART NO	PACKAGE
WS-T684	500

PART NO	PACKAGE
WS-T685	500

PART NO	PACKAGE
WS-T735	500

电线固定座 WIRE CLIP 自粘式配线固定座 背胶式

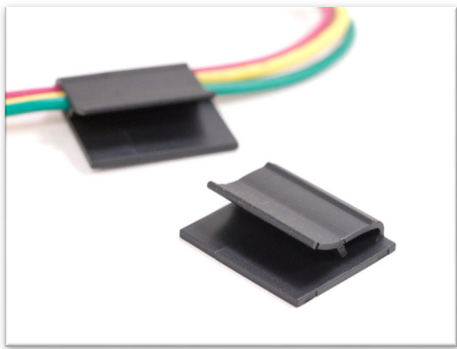

- ◆ MATERIAL : NYLON 66(UL)
- ◆ FLAME CLASS : 94V-2,94V-0
- ◆ COLOR : BLACK / NATURAL
- ◆ UNIT: mm

用途： 电线固定座,自粘式配线固定座，背胶式，固定电线于机器中，整齐美观。

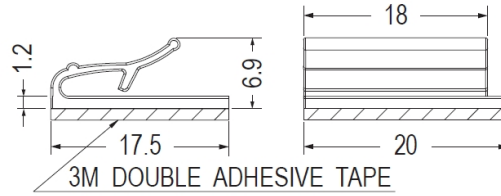

PART NO	PACKAGE
WS-T681	500

电线固定座 WIRE SADDLE 自粘式配线固定座 背胶式



- ◆ MATERIAL : NYLON 66(UL)
- ◆ FLAME CLASS : 94V-2,94V-0
- ◆ COLOR : BLACK / NATURAL
- ◆ UNIT: mm

用途： 电线固定座,自粘式配线固定座，背胶式，可快速拆卸，固定电线，维修方便，不占空间。

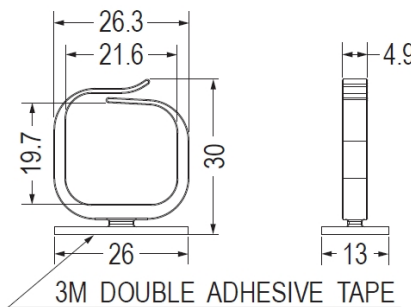

PART NO	PACKAGE
WS-T688	250

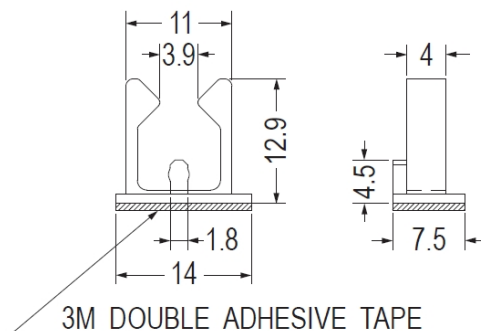
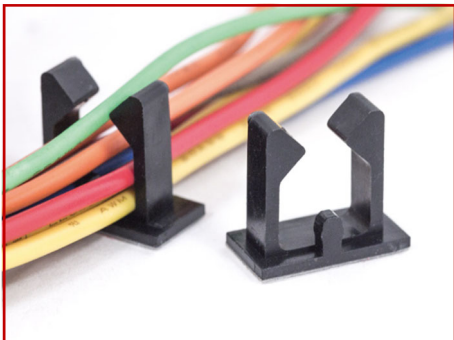

PART NO	PACKAGE
WS-T689	1000

电线固定座 CABLE CLAMP 自粘式配线固定座 背胶式

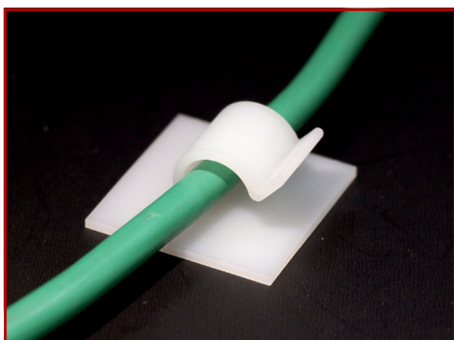

- ◆ MATERIAL : NYLON 66(UL)
- ◆ FLAME CLASS : 94V-2,94V-0
- ◆ COLOR : BLACK / NATURAL
- ◆ UNIT: mm

用途： 电线固定座,自粘式配线固定座，背胶式，可快速拆卸，固定电线，维修方便，不占空间。

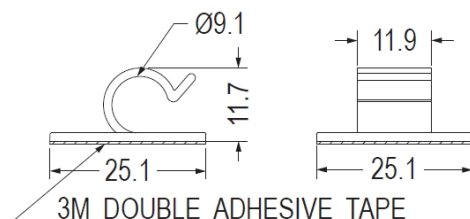

PART NO	PACKAGE
WS-T744	50

电线固定座 WIRE CLIP 自粘式配线固定座 背胶式



- ◆ MATERIAL : NYLON 66(UL)
- ◆ FLAME CLASS : 94V-2,94V-0
- ◆ COLOR : BLACK / NATURAL
- ◆ UNIT: mm

用途: 电线固定座,自粘式配线固定座,背胶式,固定电线于机器中,整齐美观。

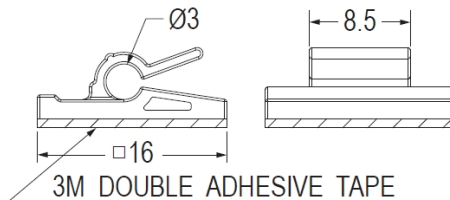

PART NO	PACKAGE
WS-T745	1000

电线固定座 WIRE MOUNT 自粘式配线固定座 背胶式

电线固定座

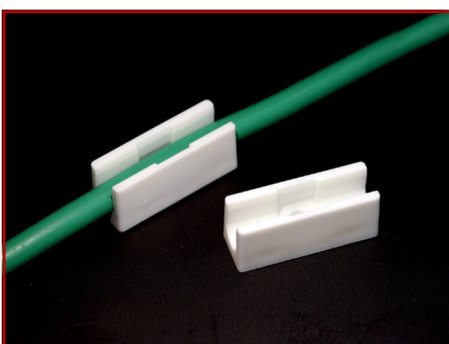

- ◆ MATERIAL : NYLON 66(UL)
- ◆ FLAME CLASS : 94V-2,94V-0
- ◆ COLOR : BLACK / NATURAL
- ◆ UNIT: mm

用途: 电线固定座,自粘式配线固定座,背胶式,可快速拆卸,固定电线,维修方便,不占空间。

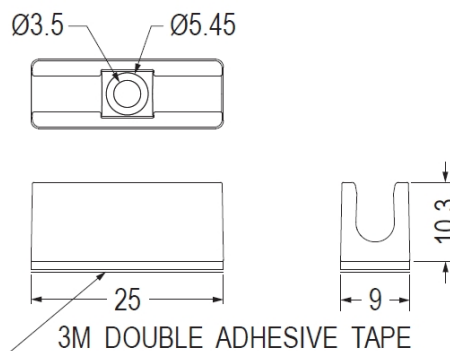

PART NO	PACKAGE
WS-T748	1000



- ◆ MATERIAL : NYLON 66(UL)
- ◆ FLAME CLASS : 94V-2,94V-0
- ◆ COLOR : BLACK / NATURAL
- ◆ UNIT: mm

用途: 电线固定座,自粘式配线固定座,背胶式,可快速拆卸,固定电线,维修方便,不占空间。

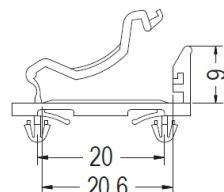
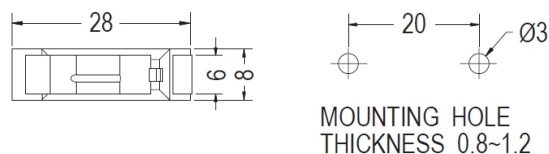

PART NO	PACKAGE
WS-T311	500

电线固定板 WIRE CLIP 自粘式配线固定座 背胶式

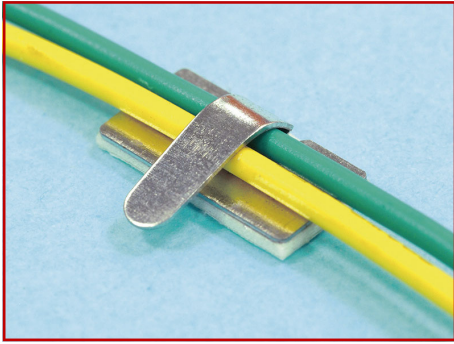

- ◆ MATERIAL : ALUMINUM
- ◆ UNIT: mm

用途： 电线固定座,自粘式配线固定座，背胶式，用于电线或零件之固定。

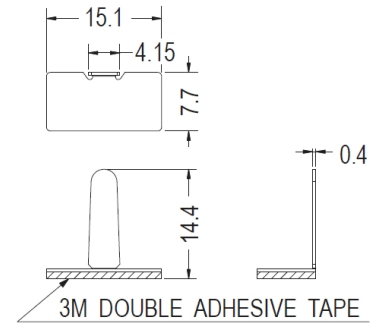
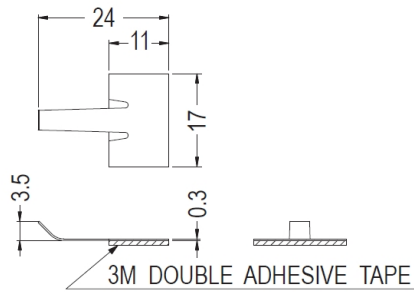

• Material: SPTE

PART NO	PACKAGE
DXG-4	1000

PART NO	PACKAGE
DXG-3	1000

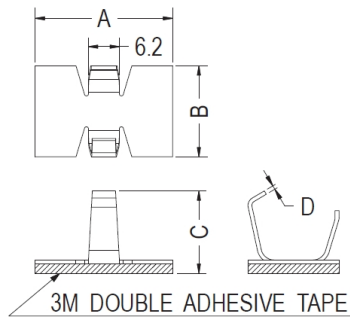
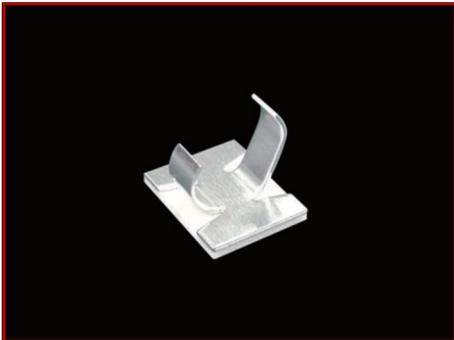

PART NO	A	B	C	D	PACKAGE
DXG-1	16.0	10.6	9.4	0.45	500
DXG-2	19.0	16.0	14.9	0.7	500

电线固定板

电线固定座 CABLE CLAMP 压线板

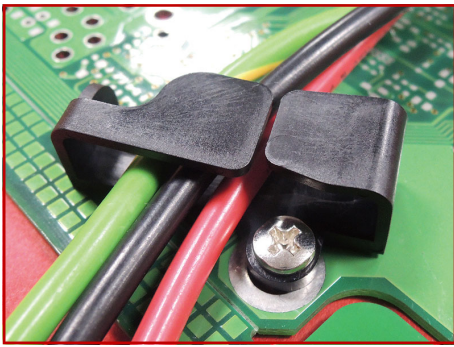

- ◆ MATERIAL : NYLON 66(UL)
- ◆ FLAME CLASS : 94V-2,94V-0
- ◆ COLOR : BLACK / NATURAL
- ◆ UNIT: mm

用途： 电线固定扣，配合螺丝，固定电线，整齐美观。

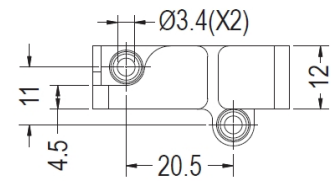
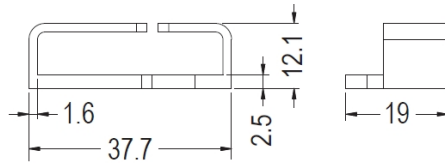

PART NO	PACKAGE
LCKK-60	1000

电线固定扣

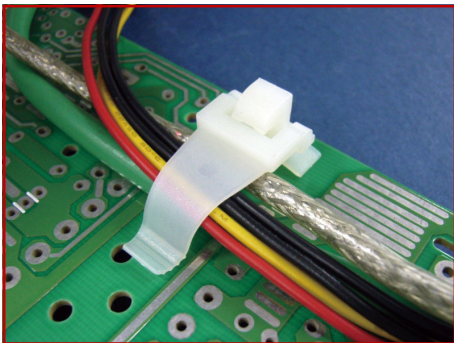

- ◆ MATERIAL : NYLON 66(UL)
- ◆ FLAME CLASS : 94V-2,94V-0
- ◆ COLOR : BLACK / NATURAL
- ◆ UNIT: mm

用途： 电线固定扣,可快速固定电线，安装容易。

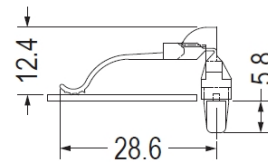
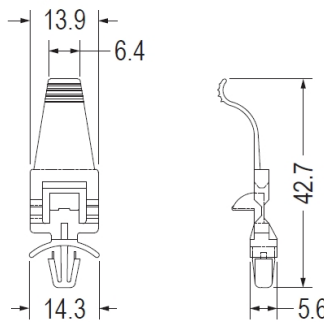

CHASSIS Ø4.8
THICKNESS 1.2~2.0

PART NO	PACKAGE
LCKK-47	1000



- ◆ MATERIAL : PC(UL)
- ◆ FLAME CLASS : 94V-2
- ◆ COLOR : TRANSPARENT / NATURAL
- ◆ UNIT: mm

用途： 电线固定扣,用于电线之固定。

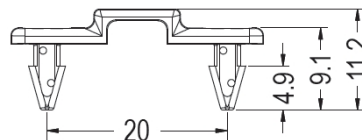

CHASSIS Ø3.0
THICKNESS 2.4



PART NO	PACKAGE
LCKK-48	1000

电线固定扣 CABLE CLAMP 压线板



- ◆ MATERIAL : NYLON 66(UL)
- ◆ FLAME CLASS : 94V-2,94V-0
- ◆ COLOR : BLACK / NATURAL
- ◆ UNIT: mm

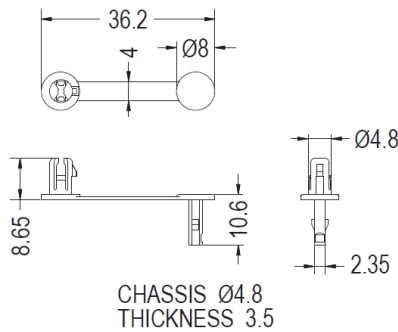

PART NO	PACKAGE
LCCK-49	500

用途： 电线固定扣,压线板,固定电线于机器上， 维修方便， 不占空间。

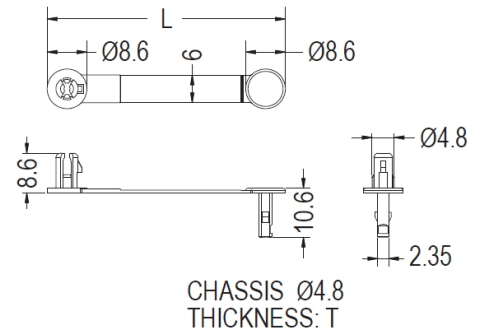

- ◆ MATERIAL : NYLON 6(UL)

PART NO	A	B	PACKAGE
LCCK-50	51.6	0.8~3.2	500
LCCK-51	71.6	0.6~3.0	500
LCCK-52	99.0	0.6~3.0	500

接地线夹 GROUNDING CABLE CLAMP 压线板 R型理线夹



- ◆ MATERIAL : SPTE
- ◆ UNIT: mm

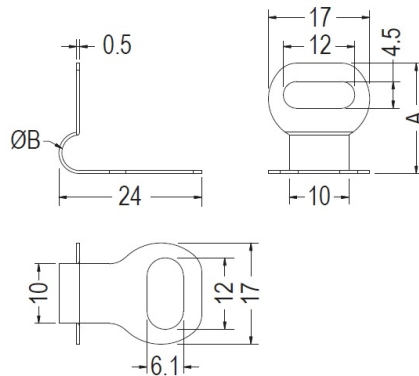

用途： 接地线夹,用于夹持隔离电线再用螺丝固定， 接地效果佳， 防干扰。

PART NO	A	B	PACKAGE
GCC-1	18.55	6.0	500
GCC-2	19.60	8.0	500

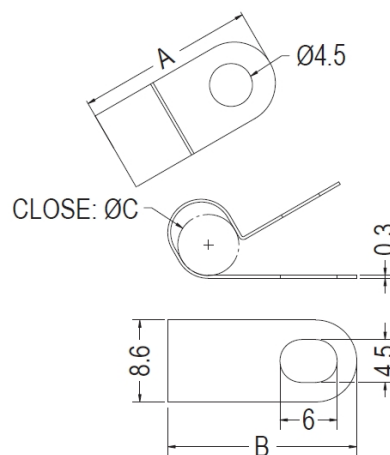
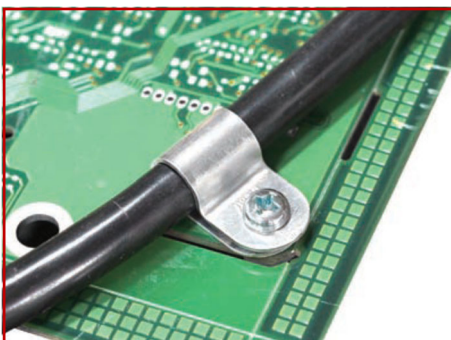

- ◆ MATERIAL : SUS
- ◆ UNIT: mm

PART NO	A	B	C	PACKAGE
GCC-3	17.2	17.6	3.0	1000
GCC-4	17.2	17.6	4.0	1000
GCC-5	17.9	18.7	4.8	1000
GCC-6	18.7	19.8	6.4	1000
GCC-7	18.65	20.62	9.0	1000

接地线夹 GROUNDING CABLE CLAMP 压线板 R型理线夹

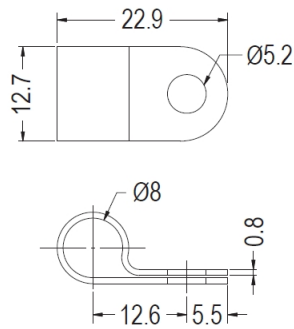
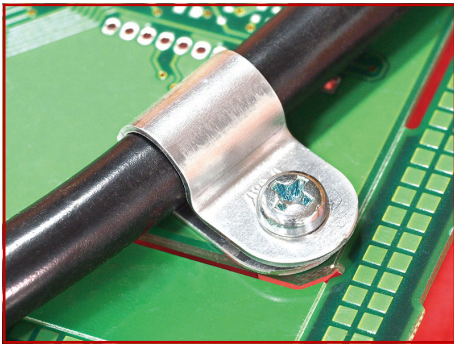

用途： 接地线夹，压线板 R型理线夹，
用于夹持隔离电线再用螺丝固
定，接地效果佳，防干扰。

- ◆ MATERIAL : ALUMINUM
- ◆ UNIT: mm

PART NO	PACKAGE
GCC-9	1000

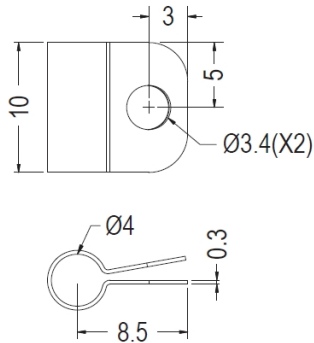
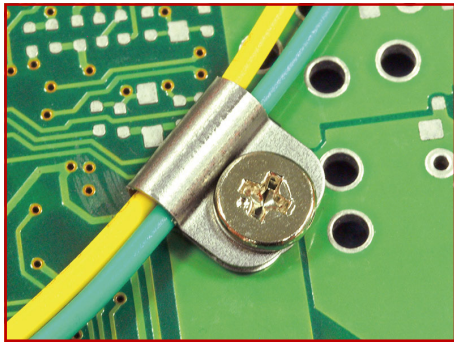

- ◆ MATERIAL : STEEL
- ◆ FINISH : ZINC PLATED
- ◆ UNIT: mm

PART NO	PACKAGE
GCC-8	1000

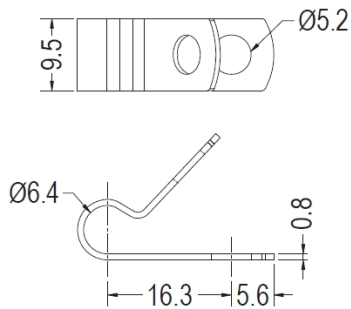

- ◆ MATERIAL : ALUMINUM
- ◆ UNIT: mm

PART NO	PACKAGE
GCC-10	1000

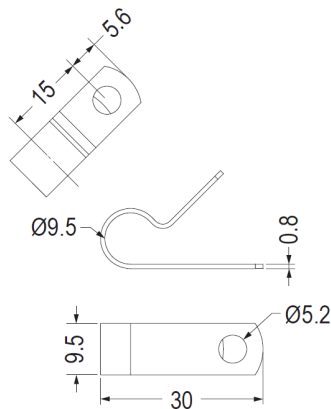

• Material: Aluminum

PART NO	PACKAGE
GCC-11	1000

接地线夹

电线固定扣 CABLE CLAMP 压线板 R型理线扣



- ◆ MATERIAL : NYLON 66(UL)
- ◆ FLAME CLASS : 94V-2,94V-0
- ◆ COLOR : BLACK / NATURAL
- ◆ UNIT: mm

用途： 电线固定扣,压线板,R型理线扣,配合螺丝, 固定电线整齐美观。

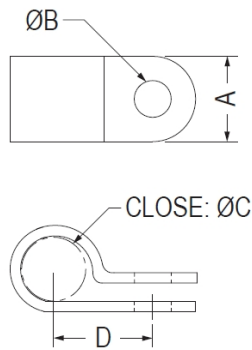

PART NO	A	B	C		D	PACKAGE
			mm	inch		
LCCK-1	6.5	3.8	3.2	1/8	6.8	1000
LCCK-2	9.2	5.4	3.2	1/8	8.2	1000
LCCK-3	13.2	5.4	3.0	1/8	8.9	1000
LCCK-4	10.0	5.4	4.5	3/16	10.2	1000
LCCK-5	9.3	5.0	6.2	1/4	10.2	1000
LCCK-6	9.5	5.0	7.6	5/16	10.5	1000
LCCK-7	9.2	5.4	8.0	5/16	10.7	1000
LCCK-8	9.5	4.8	9.0	3/8	12.4	1000
LCCK-9	12.3	5.4	9.0	3/8	13.2	500
LCCK-10	12.7	4.8	11.5	1/2	14.7	500
LCCK-11	12.9	5.4	12.8	1/2	16.0	500
LCCK-12	12.5	4.8	15.5	5/8	16.7	500
LCCK-13	12.9	5.4	17.0	3/4	19.6	200
LCCK-14	12.9	5.4	20.0	7/8	21.2	250
LCCK-16	9.9	4.4	3.0	1/8	8.5	1000
LCCK-17	9.5	3.2	8.3	5/16	12.0	1000
LCCK-18	6.3	3.7	3.5	1/7	6.4	1000
LCCK-19	9.6	4.4	5.6	1/4	12.1	1000
LCCK-20	11.6	6.4	5.6	1/4	12.1	1000
LCCK-21	10.0	4.2	5.0	1/4	9.5	1000
LCCK-22	10.0	4.2	11.0	7/16	13.0	1000
LCCK-23	9.9	4.4	4.5	3/16	7.75	1000
LCCK-24	10.0	4.3	6.5	1/4	9.9	1000
LCCK-26	10.0	4.2	11.5	1/2	14.0	1000
LCCK-27	10.0	4.2	5.0	1/4	9.5	1000
LCCK-54	10.9	5.0	7.5	5/16	10.5	1000
LCCK-55	12.9	6.6	7.5	5/16	10.5	1000
LCCK-62	10.0	3.5	4.5	3/16	10.2	1000
LCCK-67	12.7	5.2	9.5	3/8	12.3	1000
LCCK-69	12.7	5.2	31.75	1-1/4	26.9	250

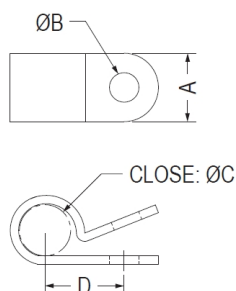

PART NO	A	B	C		D	PACKAGE
			mm	inch		
LCCK-15	12.9	5.4	24~27	1-1/8	23.5	200
LCCK-53	6.5	3.3	3.0	1/8	9.5	1000
LCCK-40	4.0	2.5	3.1	1/8	6.0	1000

电线固定扣

电线固定扣 CABLE CLAMP 压线板 R型理线夹



- ◆ MATERIAL : NYLON 66(UL)
- ◆ FLAME CLASS : 94V-2,94V-0
- ◆ COLOR : BLACK / NATURAL
- ◆ UNIT: mm

用途： 电线固定扣,压线板,R型理线扣,
配合螺丝, 固定电线整齐美观。

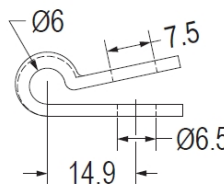
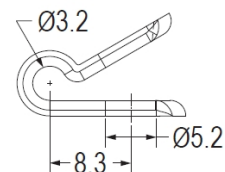
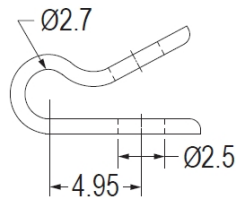
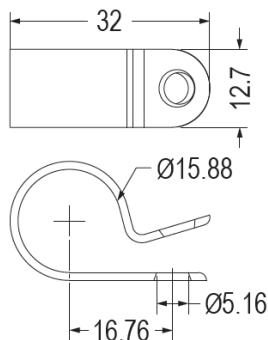
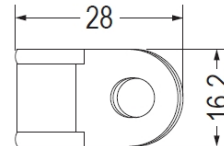
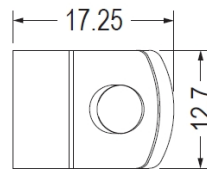
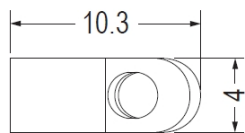

PART NO	PACKAGE
LCCK-32	1000

PART NO	PACKAGE
LCCK-65	1000

PART NO	PACKAGE
LCCK-28	1000

PART NO	PACKAGE
LCCK-70	1000

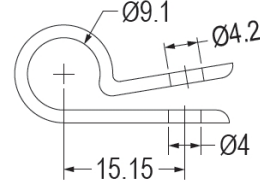
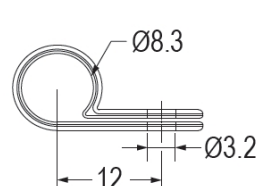
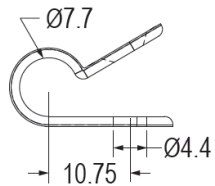
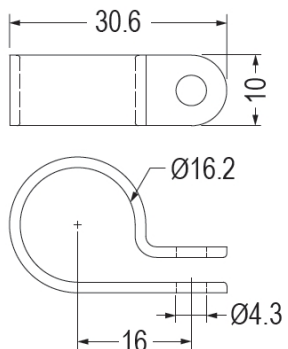
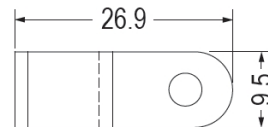
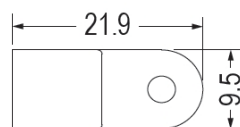
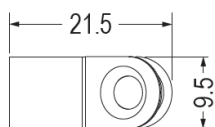

PART NO	PACKAGE
LCCK-63	1000

PART NO	PACKAGE
LCCK-33	1000

PART NO	PACKAGE
LCCK-56	1000

PART NO	PACKAGE
LCCK-41	1000

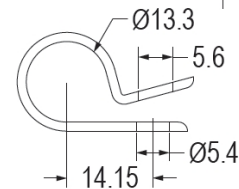
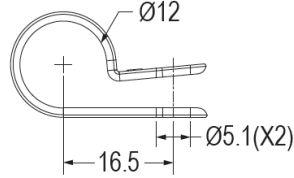
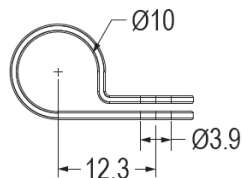
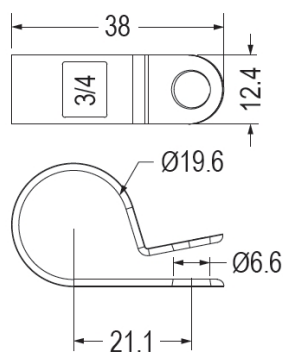
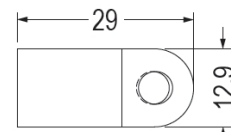
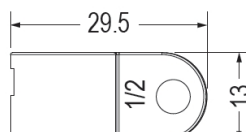
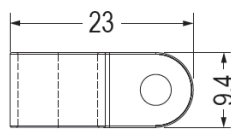

PART NO	PACKAGE
LCCK-64	1000

PART NO	PACKAGE
LCCK-66	1000

PART NO	PACKAGE
LCCK-29	500

PART NO	PACKAGE
LCCK-68	500

电线固定扣 CABLE CLAMP 压线板 R型理线扣



- ◆ MATERIAL : NYLON 66(UL)
- ◆ FLAME CLASS : 94V-2,94V-0
- ◆ COLOR : BLACK / NATURAL
- ◆ UNIT: mm

用途： 电线固定扣,压线板,R型理线扣, 配合螺丝， 固定电线整齐美观。

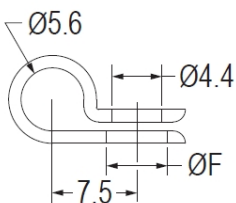
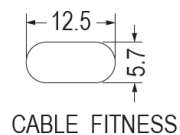
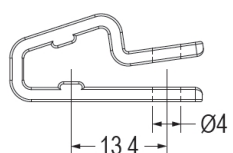
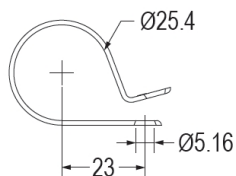
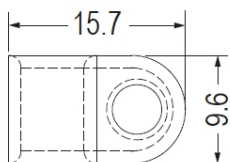
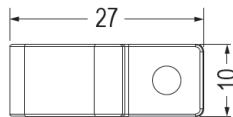
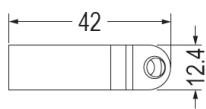

PART NO	PACKAGE
LCCK-71	1000

PART NO	PACKAGE
LCCK-39	1000

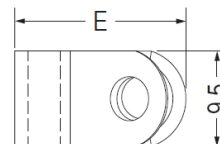
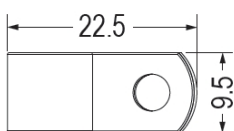

PART NO	F	PACKAGE
LCCK-25	4.4	500
LCCK-61	4.5	500

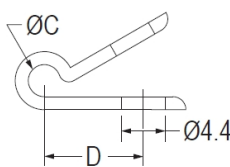
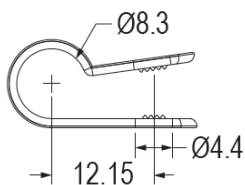

PART NO	PACKAGE
LCCK-34	1000

PART NO	C	D	E	PACKAGE
LCCK-30	3.2	9.86	17.0	500
LCCK-31	4.8	11.1	19.0	500

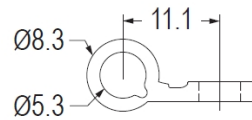
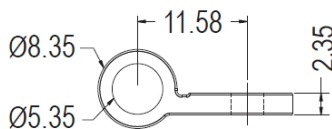
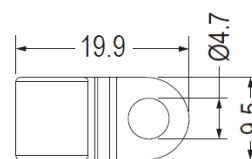
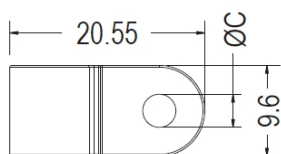
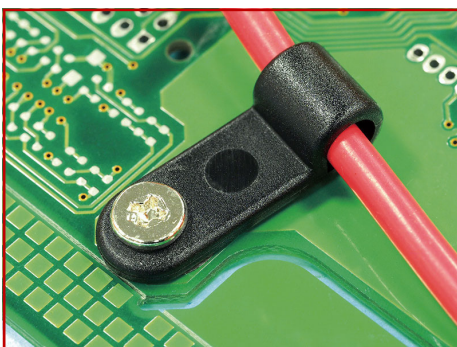

PART NO	C	PACKAGE
LCCK-36	3.5	500
LCCK-37	4.7	500

PART NO	PACKAGE
LCCK-72	500

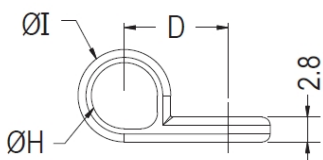
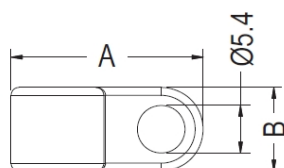

PART NO	A	B	D	H	I	PACKAGE
LCCK-38	21.75	9.5	11.75	7.5	10.5	500
LCCK-57	28.2	10.0	19.0	5.4	8.4	500

电线固定扣

电线固定扣 CABLE CLAMP 压线板 R型理线夹

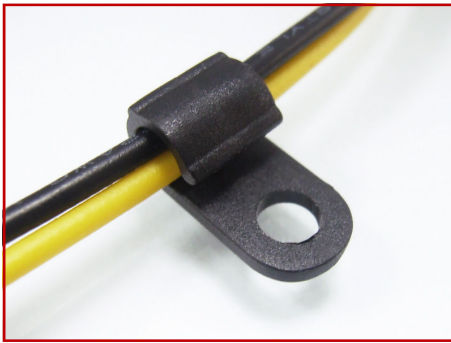

- ◆ MATERIAL : NYLON 66(UL)
- ◆ FLAME CLASS : 94V-2,94V-0
- ◆ COLOR : BLACK / NATURAL
- ◆ UNIT: mm

用途： 电线固定扣,压线板,R型理线扣, 配合螺丝, 固定电线整齐美观。

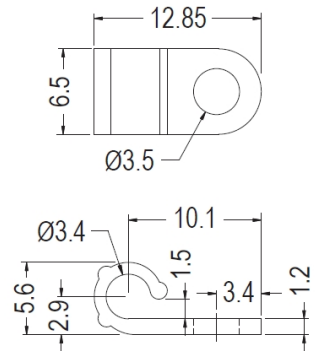

PART NO	PACKAGE
WS-T045	500

电线固定扣

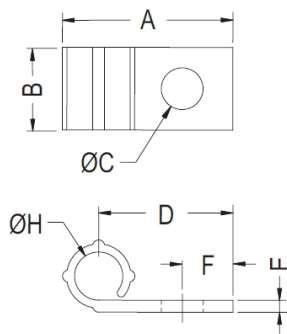
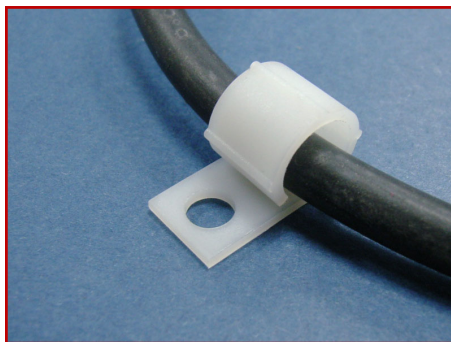

PART NO	A	B	C	D	E	F	H	PACKAGE
LCCK-43	21.2	10.3	5.2	16.7	1.5	6.3	6.0	500
LCCK-44	20.6	10.2	5.2	14.0	1.3	4.4	9.2	500
LCCK-58	21.2	10.3	3.2	16.7	1.5	6.3	6.0	500
LCCK-59	20.0	10.2	3.2	14.5	1.3	4.4	9.2	500

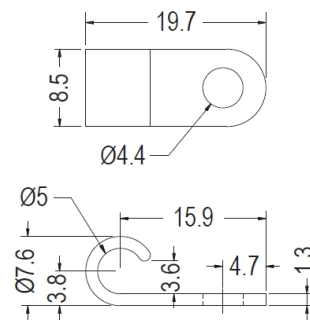

PART NO	PACKAGE
LCCK-42	500

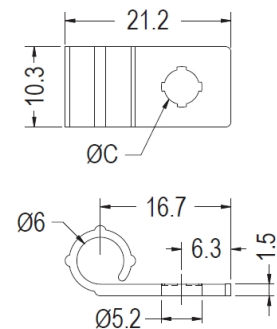
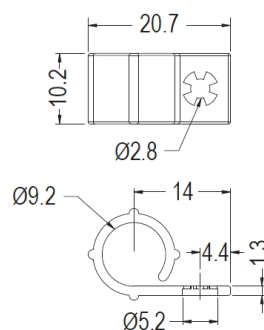

PART NO	PACKAGE
WS-T483	1000

PART NO	F	PACKAGE
WS-T481	4.5	1000
WS-T482	3.0	1000

电线固定扣 CABLE CLAMP 压线板 R型理线扣



- ◆ MATERIAL : NYLON 66(UL)
- ◆ FLAME CLASS : 94V-2,94V-0
- ◆ COLOR : BLACK / NATURAL
- ◆ UNIT: mm

用途： 电线固定扣,压线板,R型理线扣, 配合螺丝, 固定电线整齐美观。

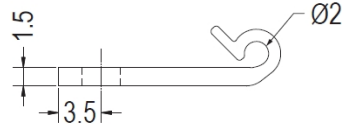
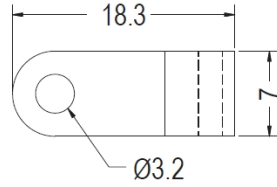

PART NO	PACKAGE
LCCK-45	1000

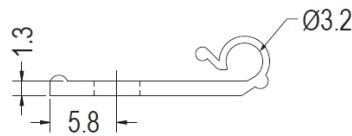
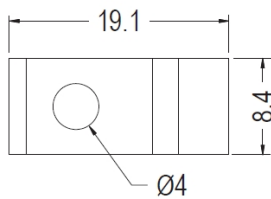
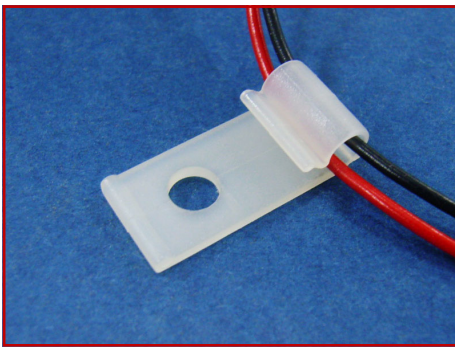

PART NO	PACKAGE
LCCK-46	1000

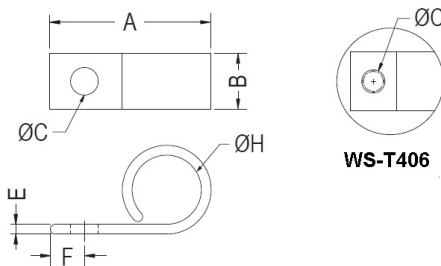
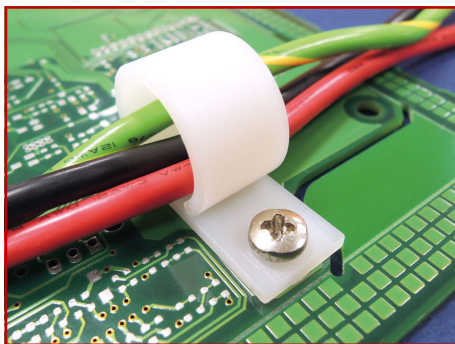

PART NO	A	B	C	E	F	H	PACKAGE
WS-T043	39.85	12.6	5.15	2.2	5.18	26.0	250
WS-T044	53.5	12.6	5.0	2.5	4.8	36.9	100
WS-T403	30.0	12.7	5.0	2.0	5.0	16.0	500
WS-T404	29.5	10.2	5.08	1.8	6.35	12.7	500
WS-T405	29.5	10.2	3.2	1.8	6.35	12.7	500
WS-T406	30.0	12.7	5.0	2.0	5.0	16.0	500
WS-T407	32.54	12.7	5.18	2.03	4.82	19.05	500
WS-T729	32.54	12.7	6.3	2.03	4.82	19.1	500

电线固定扣

电线固定扣 CABLE CLAMP 压线板 R型理线夹

用途： 电线固定扣,压线板,R型理线扣,
配合螺丝， 固定电线整齐美观。

- ◆ MATERIAL : NYLON 66(UL)
- ◆ FLAME CLASS : 94V-2,94V-0
- ◆ COLOR : BLACK / NATURAL
- ◆ UNIT: mm

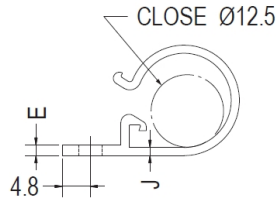
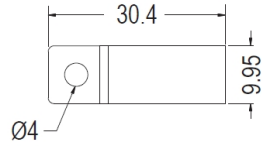

PART NO	E	J	PACKAGE
WS-T030	1.8	1.4	500
WS-T408	1.4	1.3	500

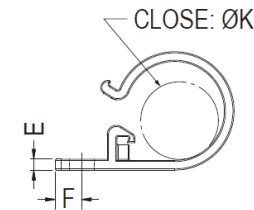
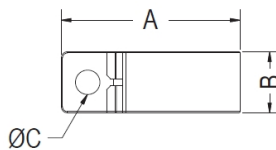

PART NO	A	B	C	E	F	K	PACKAGE
WS-T031	29.2	10.0	4.0	1.8	4.3	12.7	500
WS-T032	21.0	10.0	4.0	1.2	6.0	5.5	1000
WS-T033	39.6	12.7	4.0	2.0	4.2	17.8	200
WS-T034	50.0	12.7	4.0	2.2	4.3	25.0	200
WS-T409	21.0	10.0	3.1	1.2	6.0	5.5	1000
WS-T730	29.2	10.0	3.1	1.8	4.3	12.7	500

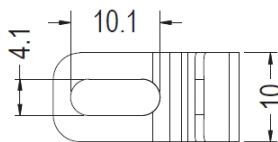
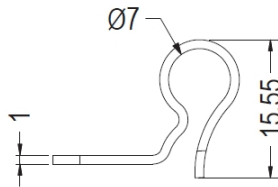
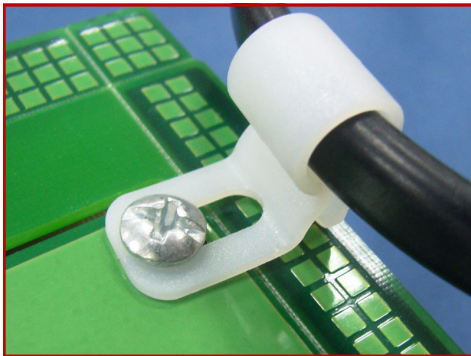

PART NO	PACKAGE
LCCK-35	1000

电线固定扣 CABLE CLAMP 压线板

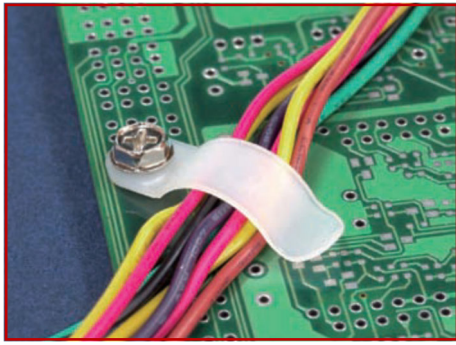

- ◆ MATERIAL : NYLON 66(UL)
- ◆ FLAME CLASS : 94V-2,94V-0
- ◆ COLOR : BLACK / NATURAL
- ◆ UNIT: mm

用途： 电线固定扣,压线板,使用螺丝将电线固定于机器中，固定电线不易松动。

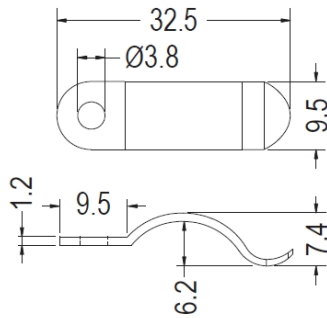

PART NO	PACKAGE
WS-T046	1000

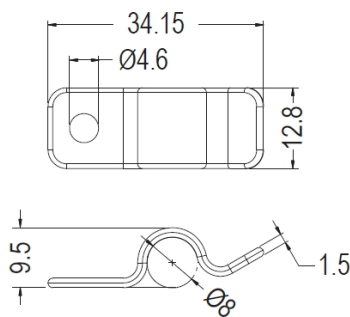

PART NO	PACKAGE
WS-T048	1000

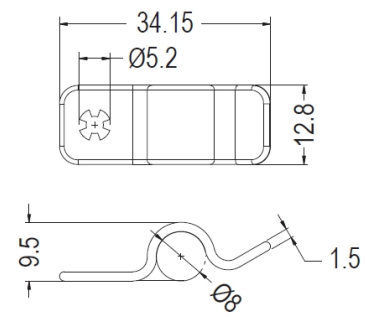

PART NO	PACKAGE
WS-T470	1000

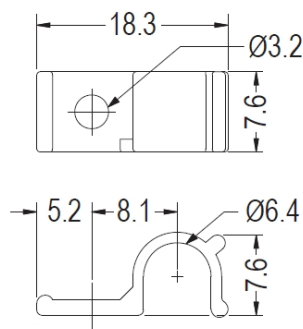

PART NO	PACKAGE
WS-T530	1000

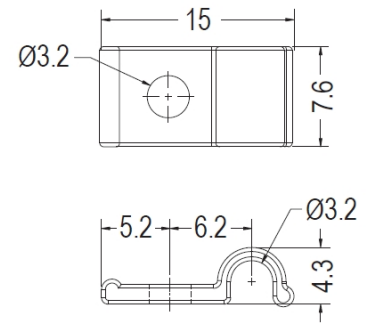

PART NO	PACKAGE
WS-T731	1000

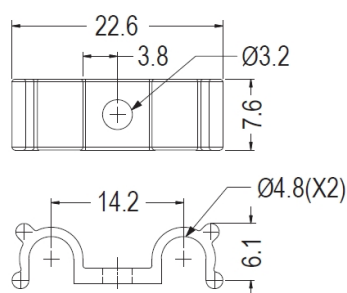
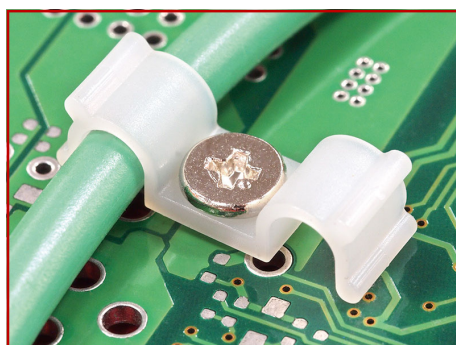

PART NO	PACKAGE
WS-T614	1000

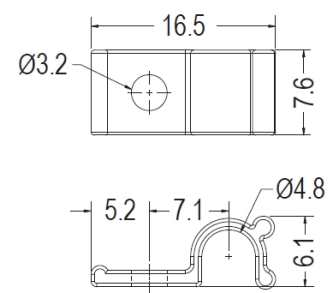

PART NO	PACKAGE
WS-T732	1000

电线固定扣

电线固定扣 CABLE CLAMP 压线板

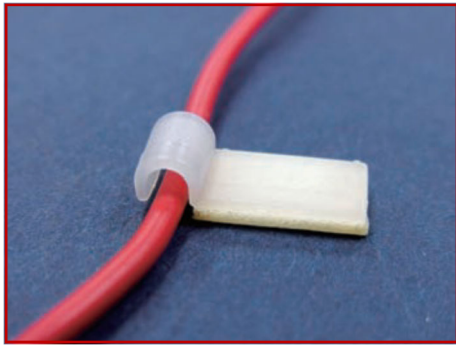

- ◆ MATERIAL : NYLON 66(UL)
- ◆ FLAME CLASS : 94V-2,94V-0
- ◆ COLOR : BLACK / NATURAL
- ◆ UNIT: mm

用途： 电线固定扣,压线板,背胶式, 可快速拆卸, 固定电线, 维修方便, 不占空间。

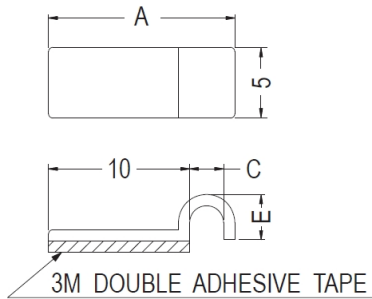

PART NO	A	C	E	PACKAGE
WS-T047	13.2	2.4	3.2	1000
WS-T413	12.3	1.5	2.4	1000

电线固定扣

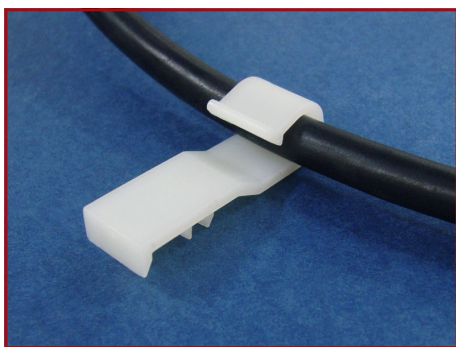

- ◆ MATERIAL : NYLON 66(UL)
- ◆ FLAME CLASS : 94V-2,94V-0
- ◆ COLOR : BLACK / NATURAL
- ◆ UNIT: mm

用途： 电线固定扣,压线板,固定电线于机器中, 整齐美观。

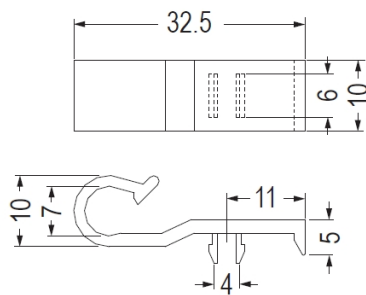

PART NO	PACKAGE
WS-T285	500

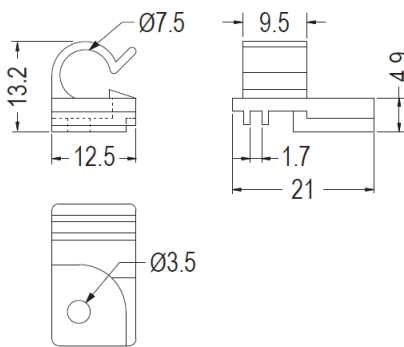
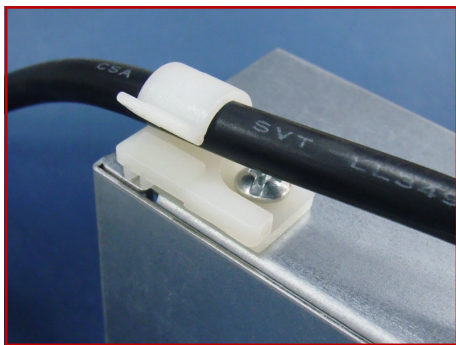

PART NO	PACKAGE
WS-T286	500

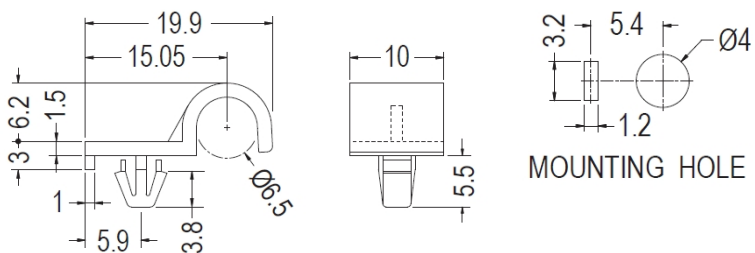
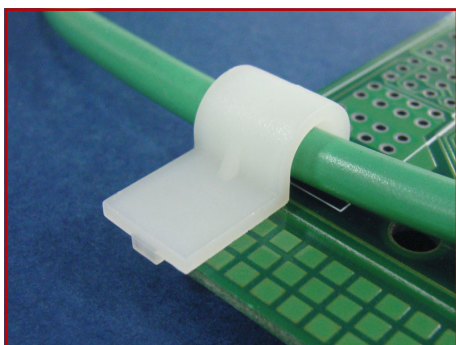

PART NO	PACKAGE
WS-T110	500

电线固定扣 CABLE CLAMP 压线板

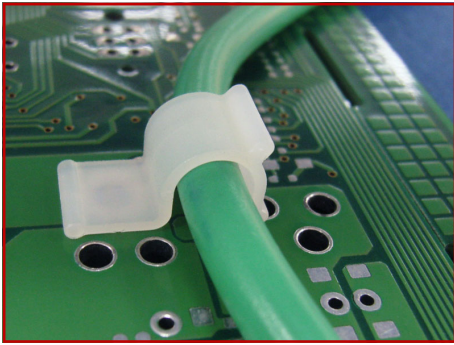

- ◆ MATERIAL : NYLON 66(UL)
- ◆ FLAME CLASS : 94V-2,94V-0
- ◆ COLOR : BLACK / NATURAL
- ◆ UNIT: mm

用途： 电线固定扣,压线板,固定电线于机器中， 整齐美观。

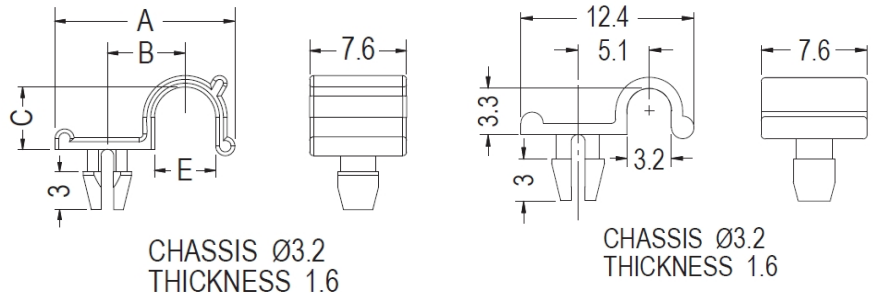

PART NO	A	B	C	E	PACKAGE
WS-T111	14.1	6.1	4.9	4.8	2000
WS-T112	15.8	7.0	6.5	6.1	2000

PART NO	PACKAGE
WS-T414	500



- ◆ MATERIAL : HIPS(UL)
- ◆ FLAME CLASS : 94HB
- ◆ COLOR : GRAY
- ◆ UNIT: mm

用途： 电线固定扣,压线板,固定LCD-TV背部电线， 美观整齐。

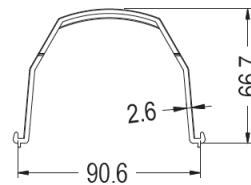
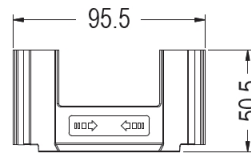

PART NO	PACKAGE
WS-T193	100

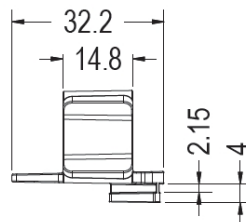
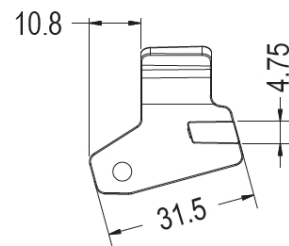
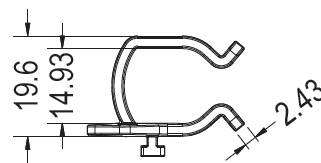

PART NO	PACKAGE
DH-73	1000

电线固定扣

电线固定扣 CABLE CLAMP 压线板

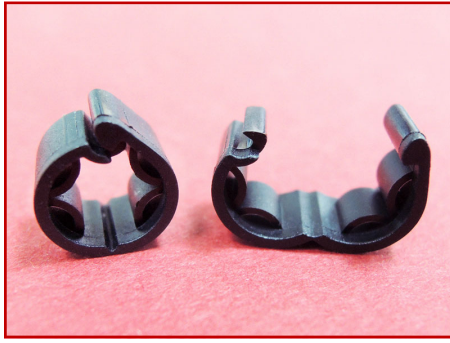

- ◆ MATERIAL : NYLON 66(UL)
- ◆ FLAME CLASS : 94V-2,94V-0
- ◆ COLOR : BLACK / NATURAL
- ◆ UNIT: mm

用途： 电线固定扣,压线板,固定电线于机器中， 整齐美观。

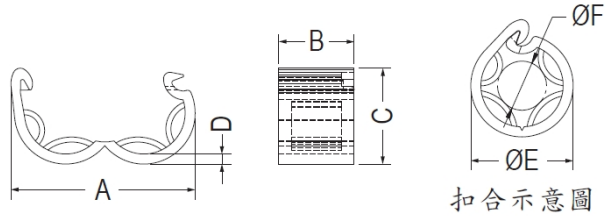

PART NO	A	B	C	D	E	F	PACKAGE
WS-T416	14.65	6.0	7.6	0.8	8.15	3.9	1000
WS-T417	19.34	5.3	11.6	1.0	10.20	5.3~5.5	1000

电线固定扣

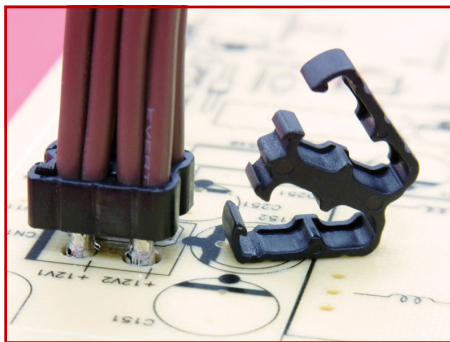

- ◆ MATERIAL : NYLON 66(UL)
- ◆ FLAME CLASS : 94V-2,94V-0
- ◆ COLOR : BLACK / NATURAL
- ◆ UNIT: mm

用途： 电线固定扣,压线板,固定电线于机器中， 防止电线断路。

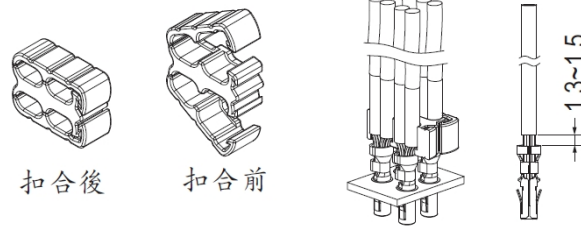
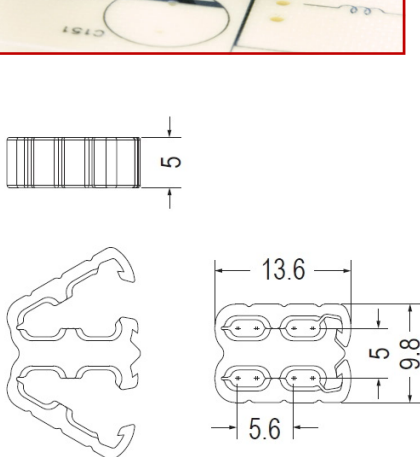

PART NO	PACKAGE
WS-T415	1000

电线固定扣 CABLE CLAMP 压线板



- ◆ MATERIAL : NYLON 66(UL)
- ◆ FLAME CLASS : 94V-2,94V-0
- ◆ COLOR : BLACK / NATURAL
- ◆ UNIT: mm

用途： 电线固定扣,压线板,固定电线于机器中，防止电线断路。

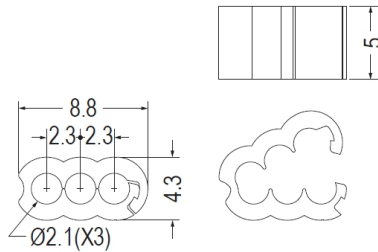

UNIT FOLDED VIEW

PART NO	PACKAGE
WS-T014	1000

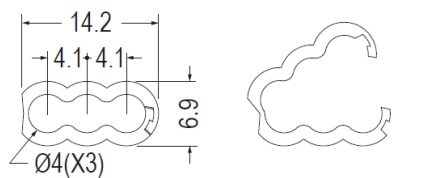

UNIT FOLDED VIEW

PART NO	PACKAGE
WS-T015	1000

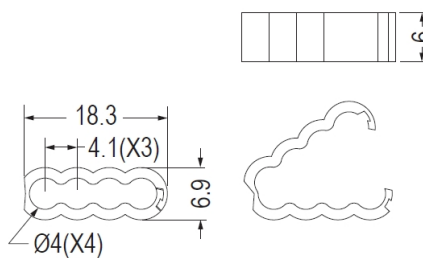

UNIT FOLDED VIEW

PART NO	PACKAGE
WS-T016	1000

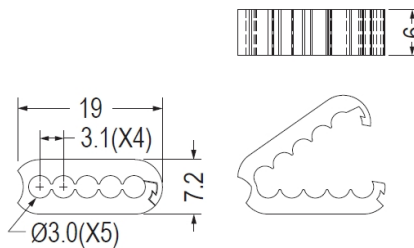

UNIT FOLDED VIEW

- ◆ COLOR : GRAY

PART NO	PACKAGE
WS-T575	1000

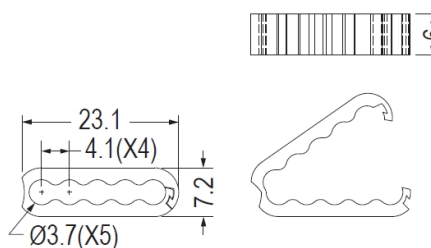
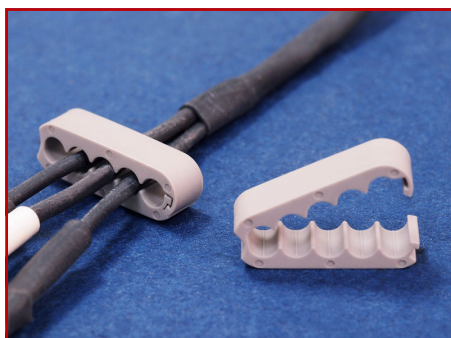

UNIT FOLDED VIEW

- ◆ COLOR : GRAY

PART NO	PACKAGE
WS-T733	1000

电线固定扣 CABLE CLAMP 压线板

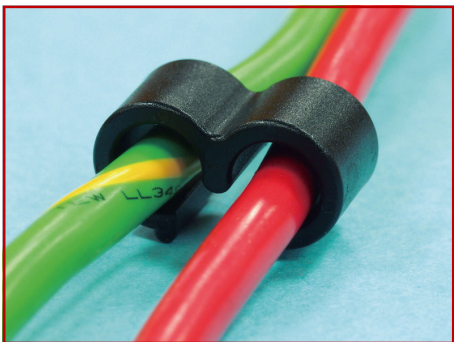

- ◆ MATERIAL : NYLON 66(UL)
- ◆ FLAME CLASS : 94V-2,94V-0
- ◆ COLOR : BLACK / NATURAL
- ◆ UNIT: mm

用途： 电线固定扣,压线板,固定电线于机器中， 整齐美观。

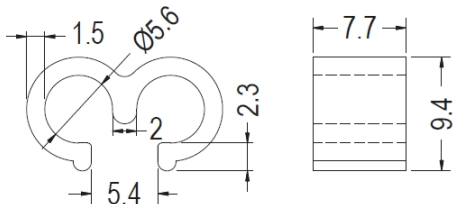

PART NO	PACKAGE
WS-T531	1000

电线固定扣

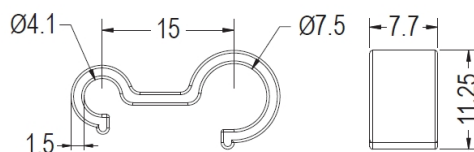

PART NO	PACKAGE
WS-T673	1000



- ◆ MATERIAL : NYLON 66(UL)/ABS (UL)/PC+ABS(UL)
- ◆ FLAME CLASS : 94V-2/94V-0/94HB
- ◆ COLOR : BLACK / NATURAL
- ◆ UNIT: mm

用途： 电线固定扣,压线板,使用螺丝将电线固定于机器中， 固定电线不易松动。

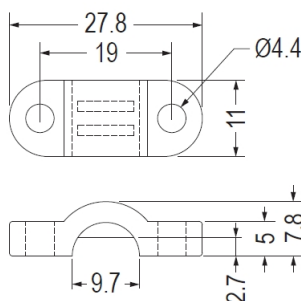

RT NO	PACKAGE
WS-T115	500



- ◆ MATERIAL : NYLON 66(UL)
- ◆ FLAME CLASS : 94V-2,94V-0
- ◆ COLOR : BLACK / NATURAL
- ◆ UNIT: mm

- ◆ MATERIAL : NYLON 66(UL)
- ◆ FLAME CLASS : 94HB
- ◆ COLOR : BLACK
- ◆ UNIT: mm

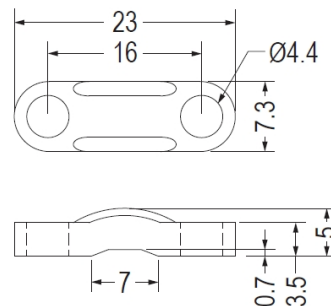
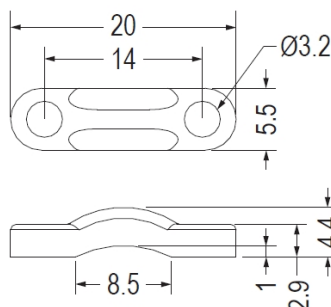

RT NO	PACKAGE
WS-T117	500

RT NO	PACKAGE
WS-T118	1000

电线固定扣 CABLE CLAMP 压线板



- ◆ MATERIAL : NYLON 66(UL)
- ◆ FLAME CLASS : 94HB
- ◆ COLOR : BLACK
- ◆ UNIT: mm

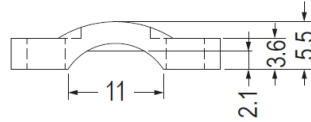
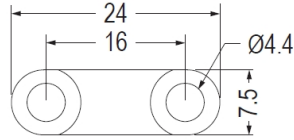

PART NO	PACKAGE
WS-T119	1000

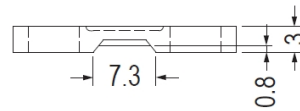
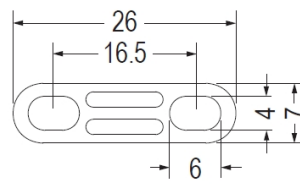

PART NO	PACKAGE
WS-T120	1000

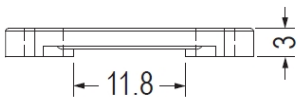
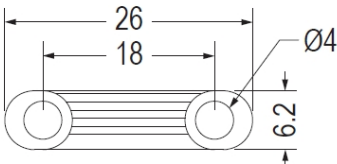

PART NO	PACKAGE
WS-T574	1000

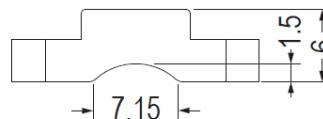
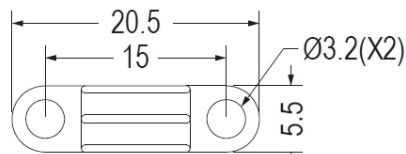
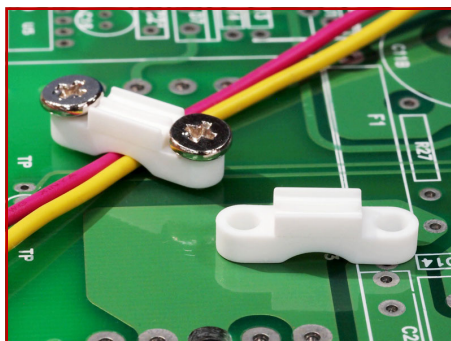

- ◆ MATERIAL : NYLON 6(UL)
- ◆ FLAME CLASS : 94V-2
- ◆ COLOR : NATURAL
- ◆ UNIT: mm

PART NO	PACKAGE
WS-T674	1000

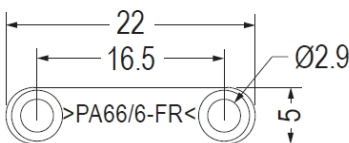

- ◆ MATERIAL : NYLON 66(UL)
- ◆ FLAME CLASS : 94V-2,94V-0
- ◆ COLOR : BLACK / NATURAL
- ◆ UNIT: mm

PART NO	PACKAGE
WS-T116	1000

电线固定扣

电线固定扣 CABLE CLAMP 压线板



- ◆ MATERIAL : ABS(UL)
- ◆ FLAME CLASS : 94HB
- ◆ COLOR : BLACK
- ◆ UNIT: mm

用途： 电线固定扣,压线板,使用螺丝将电线固定于机器中，固定电线不易松动。

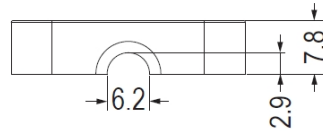
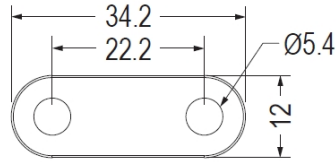

PART NO	PACKAGE
WS-T122	1000

- ◆ MATERIAL : NYLON 66(UL)
- ◆ FLAME CLASS : 94V-2,94V-0
- ◆ COLOR : BLACK / NATURAL
- ◆ UNIT: mm

PART NO	PACKAGE
WS-T532	1000

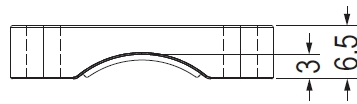
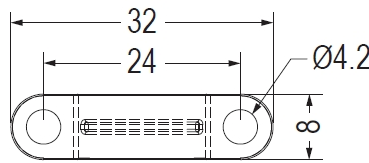
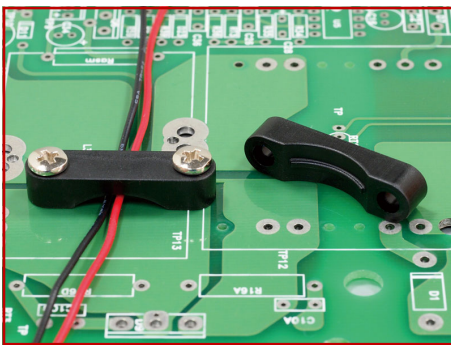

- ◆ MATERIAL : NYLON 66(UL)
- ◆ FLAME CLASS : 94V-2,94V-0
- ◆ COLOR : BLACK / NATURAL
- ◆ UNIT: mm

RT NO	PACKAGE
WS-T675	500

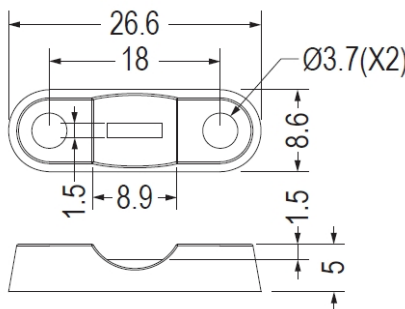
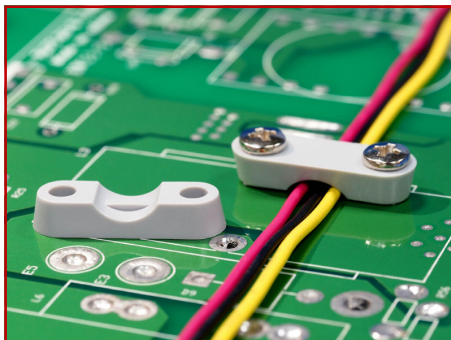

- ◆ MATERIAL : NYLON 66(UL)
- ◆ FLAME CLASS : 94V-2,94V-0
- ◆ COLOR : BLACK / NATURAL/GRAY
- ◆ UNIT: mm

RT NO	PACKAGE
WS-T121	500

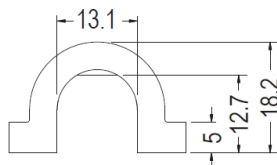
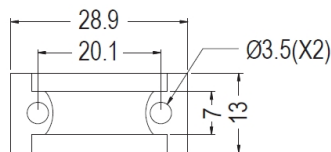

- ◆ MATERIAL : NYLON 66(UL)
- ◆ FLAME CLASS : 94V-2,94V-0
- ◆ COLOR : BLACK / NATURAL/GRAY
- ◆ UNIT: mm

RT NO	PACKAGE
WS-T123	1000

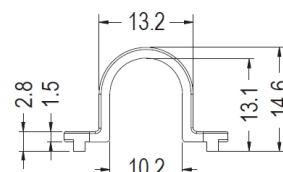
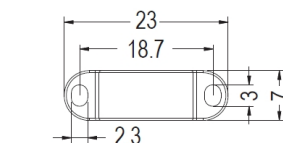

电线固定扣 CABLE CLAMP 压线板

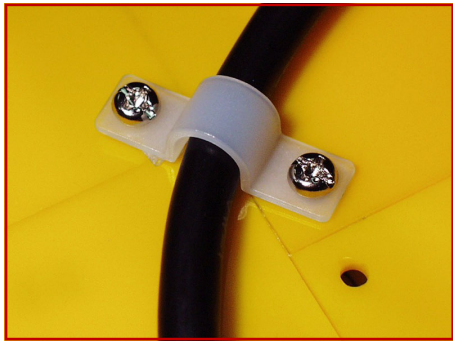

- ◆ MATERIAL : NYLON 66(UL)
- ◆ FLAME CLASS : 94V-2/94V-0
- ◆ COLOR : BLACK/NATUAL/GRAY
- ◆ UNIT: mm

用途： 电线固定扣,压线板,使用螺丝将电线固定于机器中，固定电线不易松动。

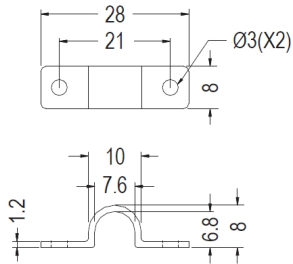

PART NO	PACKAGE
WS-T113	1000

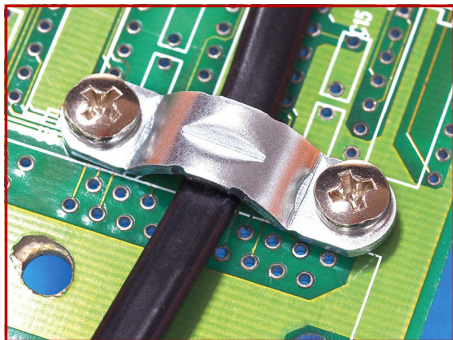

- ◆ MATERIAL : NYLON 66(UL)
- ◆ UNIT: mm

用途： 电线固定扣,压线板,使用螺丝将电线固定于机器中，固定电线不易松动。

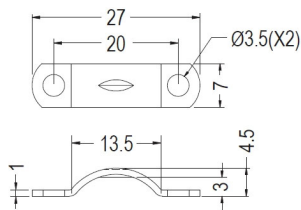

PART NO	PACKAGE
WS-T114	1000

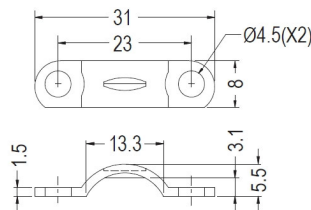

PART NO	PACKAGE
WS-T643	1000

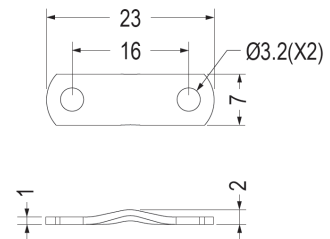

PART NO	PACKAGE
WS-T910	1000

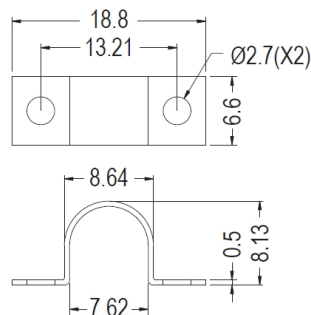
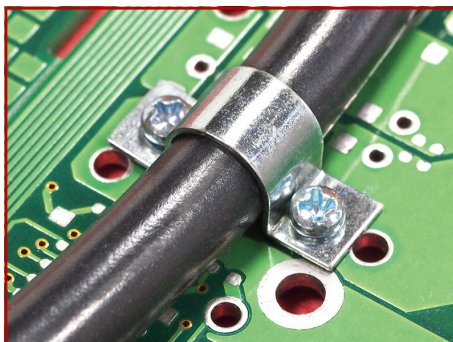

- ◆ MATERIAL : ZINC PLATED STEEL
- ◆ UNIT: mm

PART NO	PACKAGE
WS-T552	1000

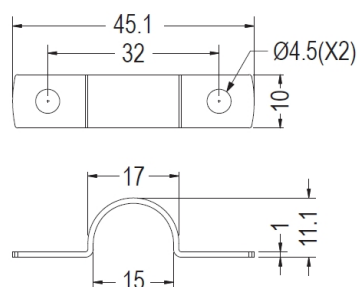

- ◆ MATERIAL : ALUMINUM
- ◆ UNIT: mm

PART NO	PACKAGE
WS-T734	1000

电线固定扣 CABLE CLAMP 压线板

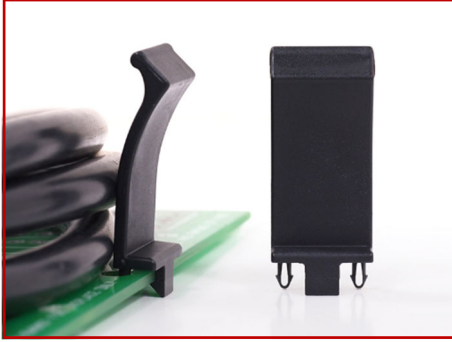

- ◆ MATERIAL : NYLON 66(UL)
- ◆ FLAME CLASS : 94V-2,94V-0
- ◆ COLOR : BLACK / NATURAL
- ◆ UNIT: mm

用途： 电线固定扣,可快速固定电线, 安装容易。可板上拆卸。

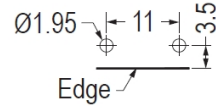
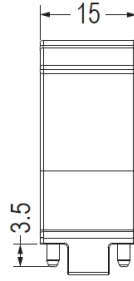
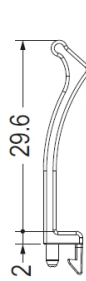

MOUNTING HOLE THICKNESS 2.1

PART NO	PACKAGE
WS-T739	1000

电线束线环 HOSE CLAMP 塑料卡箍



- ◆ MATERIAL : NYLON 66(UL)/POM/ POM(UL)
- ◆ FLAME CLASS : 94V-2,94V-0,94HB
- ◆ COLOR : BLACK / NATURAL
- ◆ UNIT: mm

用途： 电线固定扣,可快速固定电线, 安装容易。可板上拆卸。

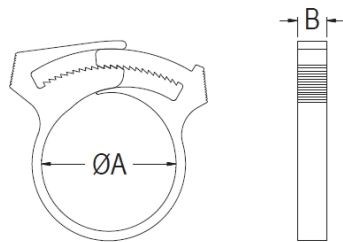

PART NO	A(MIN.~MAX)	B	PACKAGE
DXL-3	14.0~16.0	6.0	500
DXL-4	11.0~12.0	5.5	500
DXL-5	10.0~12.5	5.9	500
DXL-6	17.5~21.0	5.9	250
DXL-7	20.0~22.0	6.0	250
DXL-8	21.0~24.0	5.9	250
DXL-9	25.0~27.0	7.4	250
DXL-10	27.0~32.0	7.3	250
DXL-11	33.0~37.0	7.4	250
DLX-27	21.0~25.0	5.6	250
DXL-33	29.0~34.0	7.3	250
DXL-36	10.0~11.0	5.5	500
DXL-38	7.5~8.5	6.0	500
DXL-39	8.0~10.0	6.5	500

隔离束线座 STANDOFF CABLE CLIP

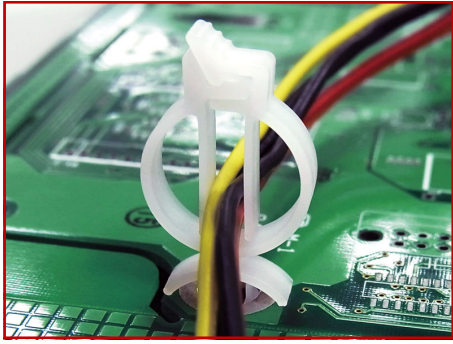

- ◆ MATERIAL : NYLON 66(UL)
- ◆ FLAME CLASS : 94V-2/94V-0
- ◆ COLOR : BLACK/NATURAL
- ◆ UNIT: mm

用途： 隔离束线座,固定电线于PC板或机板上，强韧牢固，维修方便，不占空间。

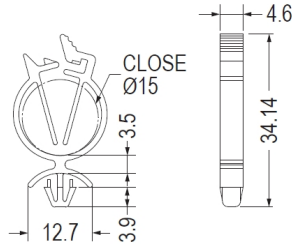

CHASSIS Ø4.8
THICKNESS 0.8-2.0

PART NO	PACKAGE
WS-T461	500

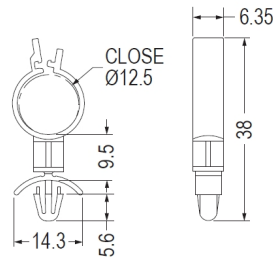

CHASSIS Ø4.8
THICKNESS 0.8-2.0

PART NO	PACKAGE
WS-T245	500

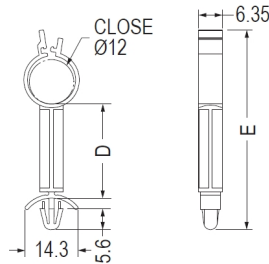
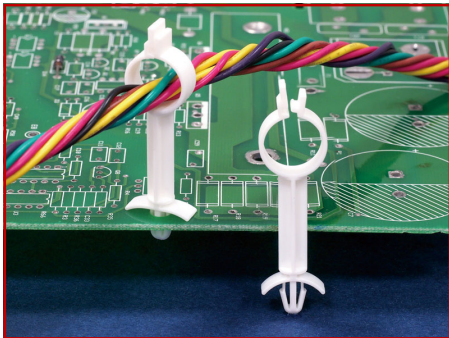

CHASSIS Ø4.8
THICKNESS 0.8-2.0

PART NO	D	E	PACKAGE
WS-T724	12.7	41.2	500
WS-T725	15.9	44.4	500
WS-T726	19.1	47.6	500
WS-T727	22.2	50.7	500
WS-T728	25.4	53.9	500

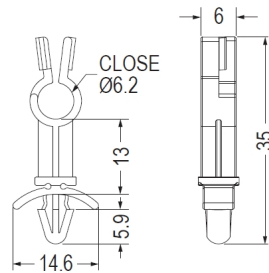

CHASSIS Ø4.8-Ø5.0
THICKNESS 0.7-2.0

PART NO	PACKAGE
WS-T872	500

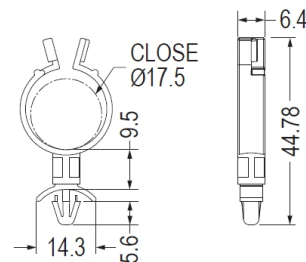

CHASSIS Ø4.8
THICKNESS 1.6

PART NO	PACKAGE
WS-T873	500

隔离束线座

隔离束线座 STADNOFF CABLE CLIP

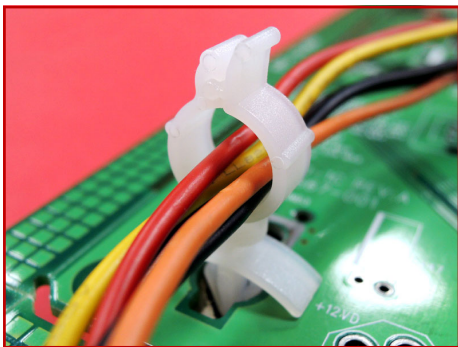

- ◆ MATERIAL : NYLON 66(UL)
- ◆ FLAME CLASS : 94V-2,94V-0
- ◆ COLOR : BLACK / NATURAL
- ◆ UNIT: mm

用途： 电线固定扣,方便固定电线于PC板或机板上， 坚固， 不占空间。

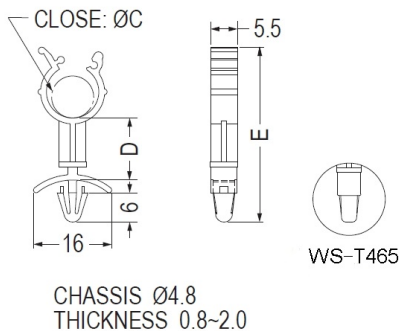

PART NO	C	D	E	PACKAGE
WS-T246	8.6	12.7	35.8	1000
WS-T247	12.2	12.7	39.4	500
WS-T462	8.6	6.4	29.5	500
WS-T463	8.6	19.1	42.2	500
WS-T464	6.7	19.1	39.4	500
WS-T465	6.7	19.1	39.4	500

隔离束线座

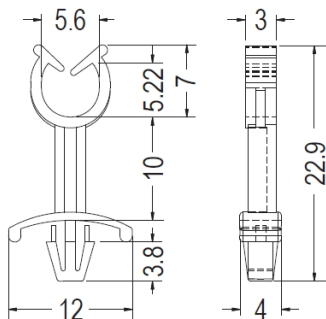
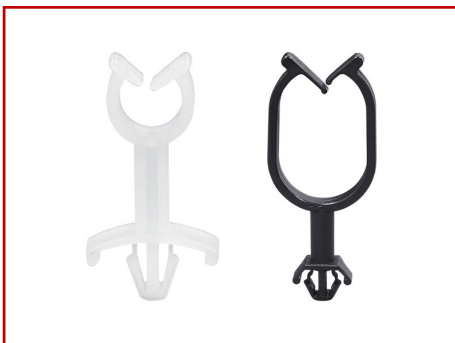

CHASSIS Ø3.5
THICKNESS 0.6~1.6

PART NO	PACKAGE
WS-T806	500

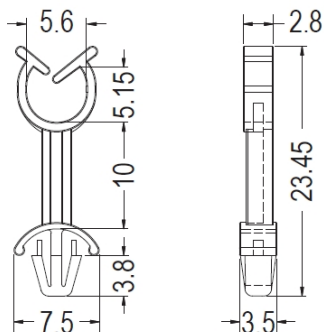
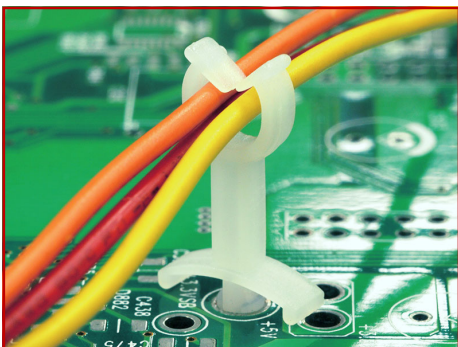

CHASSIS Ø3.5
THICKNESS 1.2~2.0

PART NO	PACKAGE
WS-T637	500

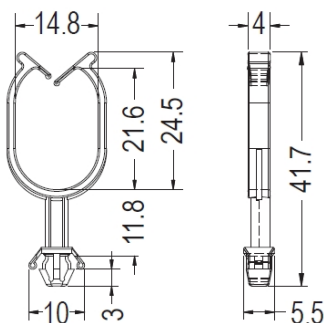
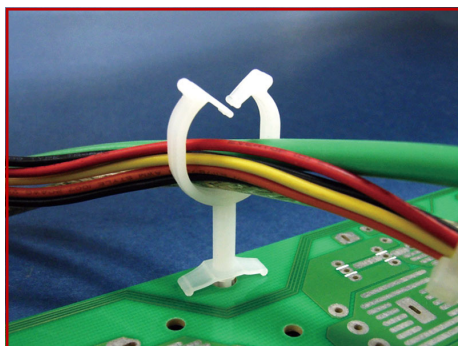

CHASSIS Ø4.8~Ø5.0
THICKNESS 0.5~2.0

PART NO	PACKAGE
WS-T807	500

隔离束线座 STANDOFF CABLE CLIP

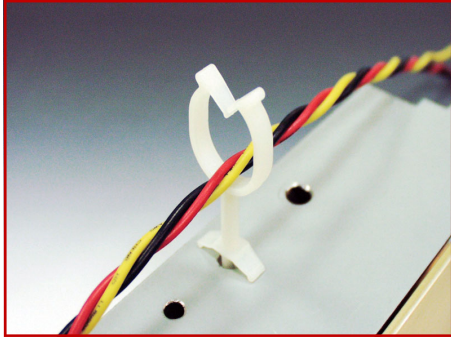

- ◆ MATERIAL : NYLON 66(UL)
- ◆ FLAME CLASS : 94V-2/94V-0
- ◆ COLOR : BLACK/NATURAL
- ◆ UNIT: mm

用途： 隔离束线座,固定电线于PC板或机板上， 维修方便， 不占空间。

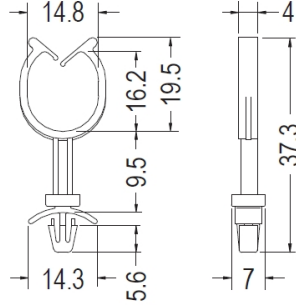

CHASSIS Ø4.8~Ø5.0
THICKNESS 0.5~2.3

PART NO	PACKAGE
WS-T808	500

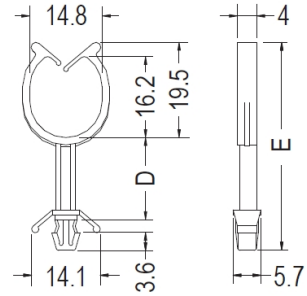

CHASSIS Ø4.8~Ø5.0
THICKNESS 0.5~2.3

PART NO	D	E	PACKAGE
WS-T809	12.7	38.5	500
WS-T810	16.8	42.6	500
WS-T811	25.0	50.8	500
WS-T812	36.8	62.6	500

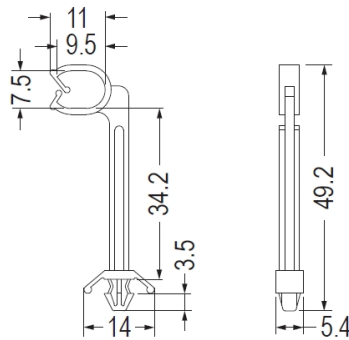
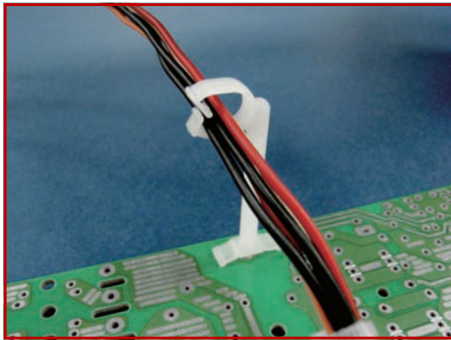

CHASSIS Ø4.8~Ø5.0
THICKNESS 0.5~2.1

PART NO	PACKAGE
WS-T813	500

扭式固定座 TWIST LOCK / TWIST TIES 扭线固定座

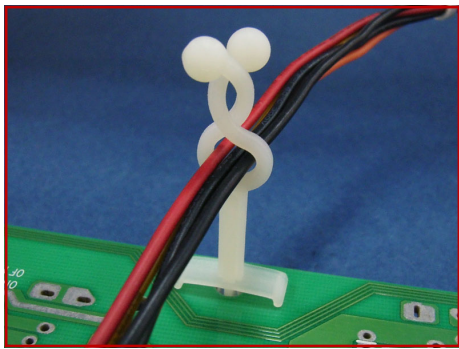

- ◆ MATERIAL : NYLON 66(UL)
- ◆ FLAME CLASS : 94V-2,94V-0
- ◆ COLOR : BLACK / NATURAL
- ◆ UNIT: mm

用途: 扭式固定座,也称扭线固定座,固定电线于机板上,维修方便,不占空间。

扭式固定座

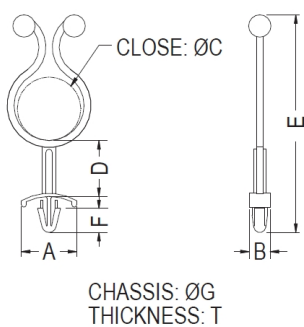

PART NO	A	B	C	D	E	F	G	T	PACKAGE
DH-32	16.1	6.0	6.1	3.1	33.8	7.3	4.8~5.0	0.8~3.0	100
DH-33	16.0	5.9	6.1	20.0	51.0	7.3	4.8~5.0	0.8~3.0	500
DH-34	16.0	5.9	6.1	35.3	66.0	7.3	4.8~5.0	0.8~3.0	500
DH-35	16.0	6.0	9.8	2.8	39.6	7.3	4.8~5.0	0.8~3.0	1000
DH-36	16.0	6.0	9.8	20.0	56.8	7.3	4.8~5.0	0.8~3.0	500
DH-37	16.2	5.9	9.8	35.2	71.5	7.3	4.8~5.0	0.8~3.0	500
DH-38	16.0	5.9	13.8	3.0	42.0	7.3	4.8~5.0	0.8~3.0	1000
DH-39	16.1	6.0	13.8	20.4	59.3	7.3	4.8~5.0	0.8~3.0	500
DH-40	16.0	5.9	13.8	35.8	74.7	7.3	4.8~5.0	0.8~3.0	500
DH-41	16.0	6.0	18.4	16.2	63.5	7.3	4.8~5.0	0.8~3.0	500
DH-42	16.0	5.4	22.3	3.0	56.8	7.3	4.8~5.0	0.8~3.0	500
DH-43	16.0	6.0	9.7	15.3	53.1	7.3	4.8~5.0	0.8~3.0	500
DH-44	16.0	6.0	18.7	8.0	55.3	7.3	4.8~5.0	0.8~3.0	500
DH-45	16.4	6.0	6.8	10.5	43.8	7.3	4.8~5.0	0.8~3.0	500
DH-46	10.5	6.0	7.0	5.6	34.7	7.3	4.8~5.0	0.8~3.0	500
DH-47	13.8	6.0	9.8	4.4	40.9	7.2	4.8~5.0	0.8~3.0	500
DH-70	12.9	4.8	7.7	8.0	37.7	3.7	3.0	0.8~2.4	1000
DH-71	15.5	4.9	18.5	8.1	58.2	5.8	3.5	1.0~2.0	500

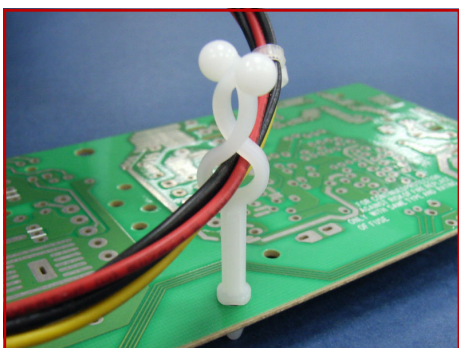

- ◆ MATERIAL : NYLON 66(UL)
- ◆ FLAME CLASS : 94V-2,94V-0
- ◆ COLOR : BLACK / NATURAL
- ◆ UNIT: mm

用途: 扭式固定座,也称扭线固定座,可快速捆扎及解开电线,安装容易。

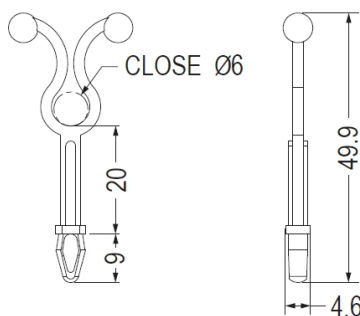

CHASSIS Ø4.6
THICKNESS 2.5

PART NO	PACKAGE
WS-T839	500

扭式固定座 TWIST LOCK / TWIST TIES 扭线固定座

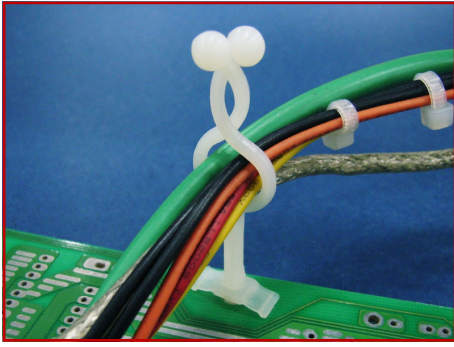

- ◆ MATERIAL : NYLON 66(UL)
- ◆ FLAME CLASS : 94V-2/94V-0
- ◆ COLOR : BLACK/NATURAL
- ◆ UNIT: mm

用途：扭式固定座,也称扭线固定座,可快速捆扎及解开电线,安装容易。

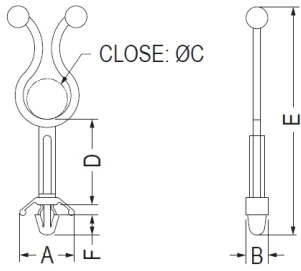

CHASSIS: ØG
THICKNESS 0.8~2.2

PART NO	A	B	C	D	E	F	G	PACKAGE
DH-48	13.8	5.5	10.4	21.0	56.5	5.0	4.8	500
DH-49	9.2	4.9	7.2	3.0	26.7	3.1	4.0	1000
DH-50	13.8	5.6	5.0	34.0	59.8	5.0	4.8	500
DH-51	14.0	5.6	10.4	4.5	37.7	5.0	4.8	1000
DH-52	13.5	5.7	10.0	43.5	78.1	4.9	4.8	250

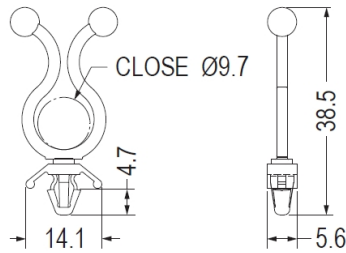
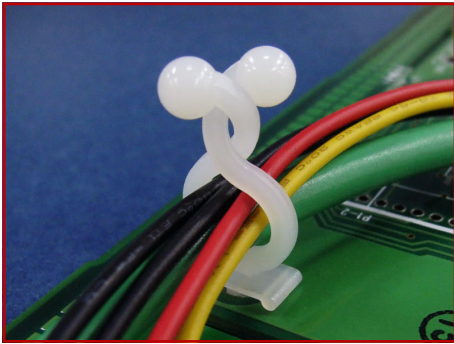

CHASSIS Ø4.8
THICKNESS 0.8~2.5

PART NO	PACKAGE
DH-53	1000

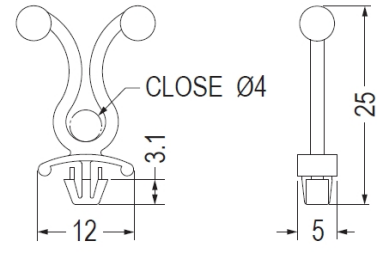

CHASSIS Ø4.0
THICKNESS 0.8~2.0

PART NO	PACKAGE
DH-72	1000

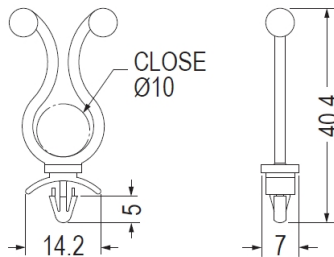
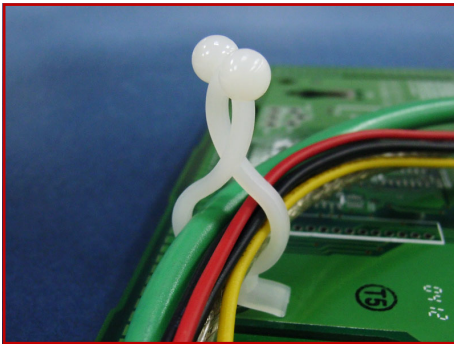

CHASSIS Ø4.0
THICKNESS 0.8~2.0

PART NO	PACKAGE
WS-T814	1000

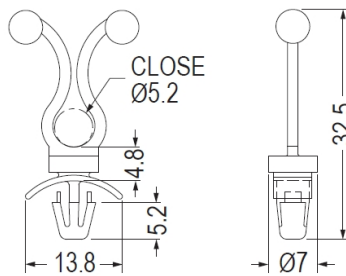
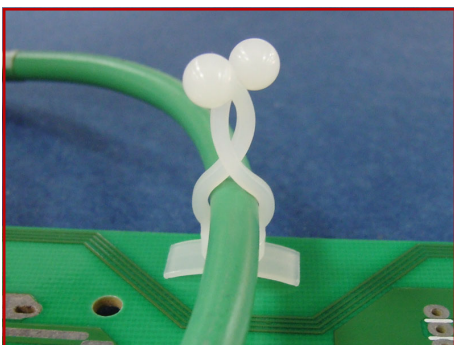

CHASSIS Ø4.8
THICKNESS 0.8~2.0

PART NO	PACKAGE
WS-T818	1000

扭式固定座

扭式固定座 TWIST LOCK / TWIST TIES 扭线固定座

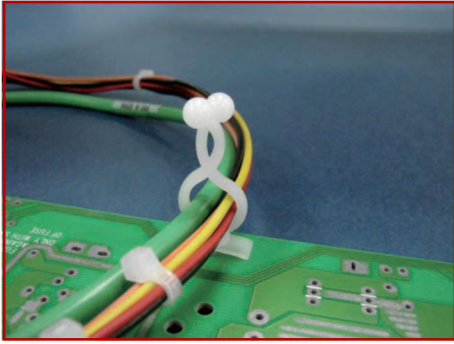

- ◆ MATERIAL : NYLON 66(UL)
- ◆ FLAME CLASS : 94V-2,94V-0
- ◆ COLOR : BLACK / NATURAL
- ◆ UNIT: mm

用途：扭式固定座,也称扭线固定座,可快速捆扎及解开电线,安装容易。

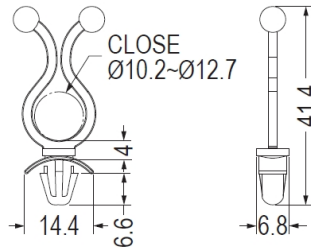

CHASSIS Ø6.0
THICKNESS 0.78~2.0

PART NO	PACKAGE
WS-T805	500

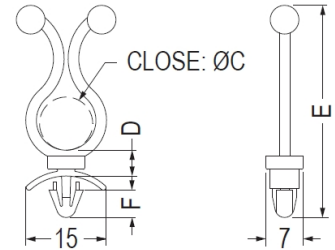

CHASSIS Ø4.8~Ø5.0
THICKNESS 0.8~2.0

PART NO	C	D	E	F	PACKAGE
WS-T815	9.8	4.9	40.2	5.2	500
WS-T816	17.1	4.9	49.4	5.2	500
WS-T861	17.5	4.85	47.6	3.6	500

扭式固定座

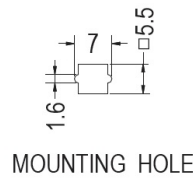
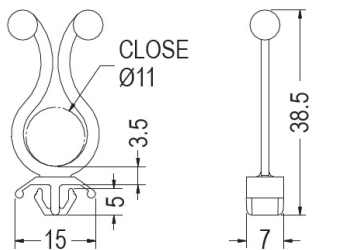
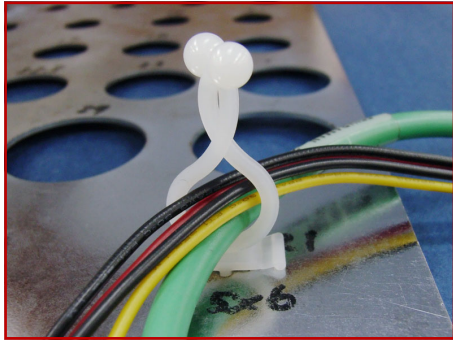

PART NO	PACKAGE
WS-T834	500

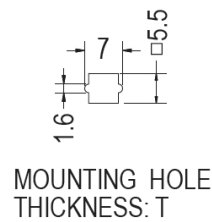
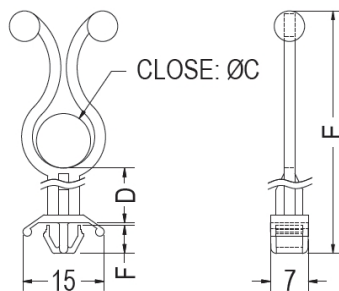
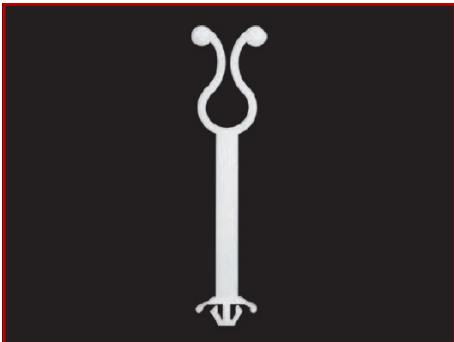

PART NO	C	D	E	F	T	PACKAGE
WS-T835	10.0	47.0	81.45	5.1	0.8~1.6	500
WS-T836	18.0	6.0	52.2	5.9	1.0~2.0	500

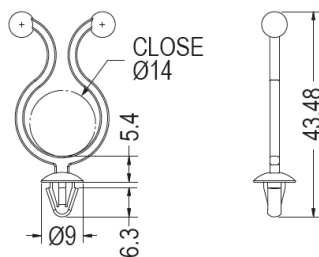
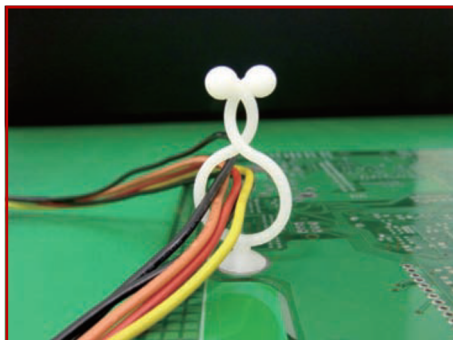

MOUNTING HOLE Ø4.8~Ø5.0
THICKNESS 1.2~2.0

PART NO	PACKAGE
WS-T250	500

扭式固定座 TWIST LOCK / TWIST TIES 扭线固定座

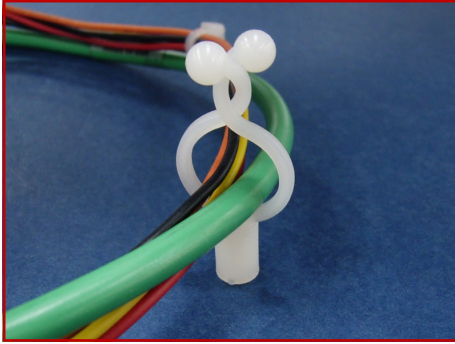

- ◆ MATERIAL : NYLON 66(UL)
- ◆ FLAME CLASS : 94V-2/94V-0
- ◆ COLOR : BLACK/NATURAL
- ◆ UNIT: mm

用途: 扭式固定座,也称扭线固定座,可快速捆扎及解开电线,安装容易。

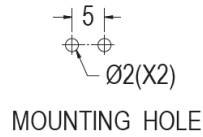
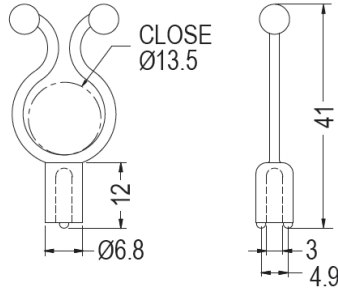

PART NO	PACKAGE
WS-T817	500

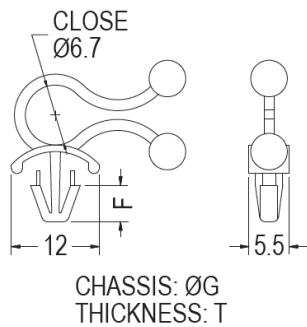
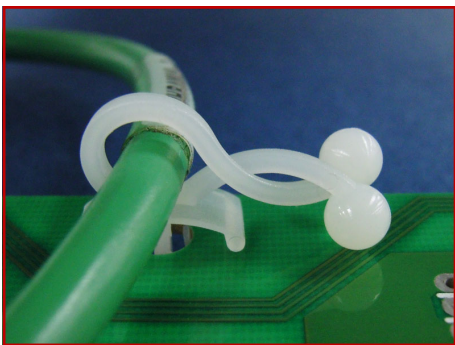

PART NO	F	G	T	PACKAGE
DH-54	5.0	4.0	1.6~4.0	500
DH-55	3.5	3.0	0.8~2.0	500

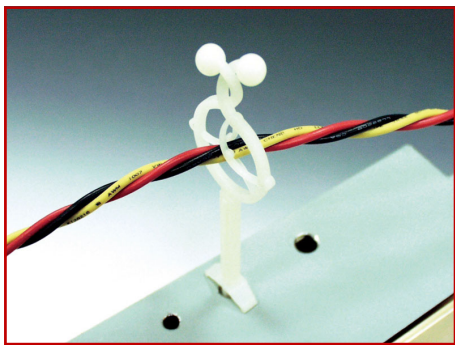

- ◆ MATERIAL : NYLON 66(UL)
- ◆ FLAME CLASS : 94V-2/94V-0
- ◆ COLOR : BLACK/NATURAL
- ◆ UNIT: mm

用途: 扭式固定座,也称扭线固定座,固定电线于机板上,维修方便,不占空间。

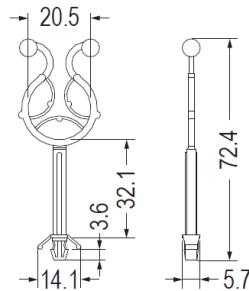

CHASSIS Ø4.8-Ø5.0
THICKNESS 0.5-2.3

PART NO	PACKAGE
WS-T848	500

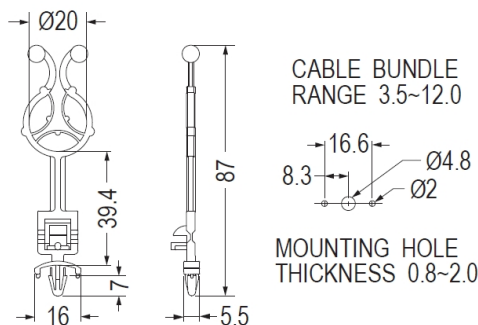

PART NO	PACKAGE
WS-T849	1000

扭式固定座

扭式固定座 TWIST LOCK / TWIST TIES 扭线固定座

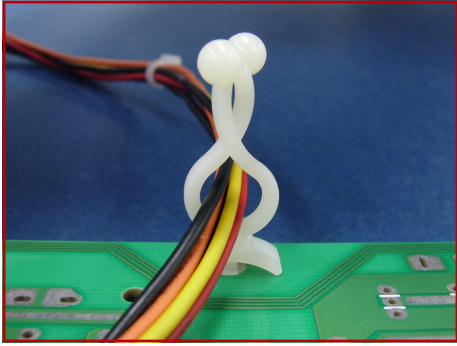

- ◆ MATERIAL : NYLON 66(UL)
- ◆ FLAME CLASS : 94V-2,94V-0
- ◆ COLOR : BLACK / NATURAL
- ◆ UNIT: mm

用途: 扭式固定座,也称扭线固定座,可快速捆扎及解开电线,装配容易,可用于木板上。

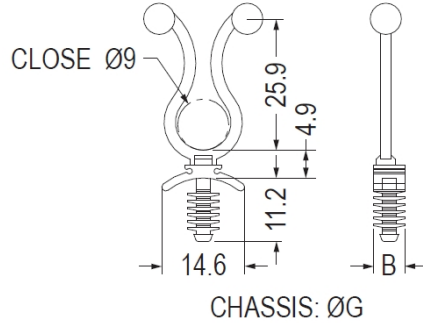

PART NO	C	D	PACKAGE
DH-56	5.5	5.0	500
DH-57	5.0	4.5	500

扭式固定座

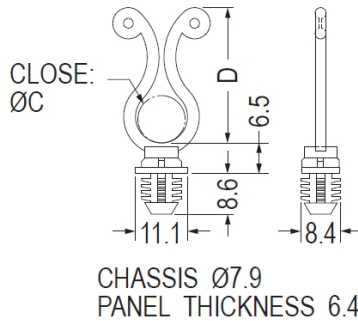
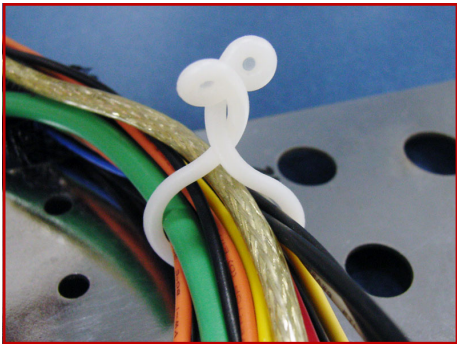

PART NO	C	D	PACKAGE
WS-T846	10.0	28.6	500
WS-T847	18.0	37.5	500

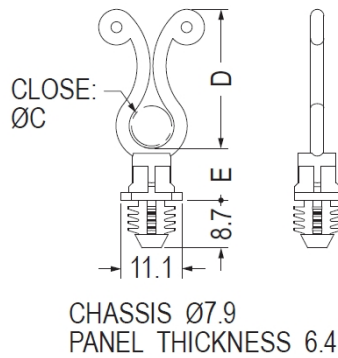

PART NO	C	D	E	PACKAGE
WS-T821	7.6~10.2	25.4	6.4	500
WS-T822	7.6~10.2	25.4	9.5	500
WS-T823	10.2~12.7	28.6	6.4	500
WS-T824	10.2~12.7	28.6	9.5	500
WS-T825	17.8~20.3	38.1	6.4	500
WS-T826	17.8~20.3	38.1	9.5	500
WS-T827	7.6~10.2	25.4	12.7	500
WS-T828	7.6~10.2	25.4	15.9	500
WS-T829	10.2~12.7	28.6	12.7	500
WS-T830	10.2~12.7	28.6	15.9	500
WS-T831	17.8~20.3	38.1	12.7	500
WS-T832	17.8~20.3	38.1	15.9	500

扭式固定座 TWIST LOCK / TWIST TIES 扭线固定座 背胶式

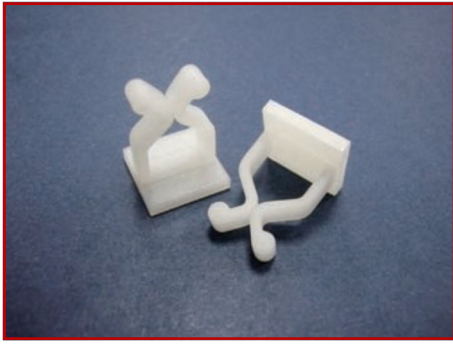

- ◆ MATERIAL : NYLON 66(UL)
- ◆ FLAME CLASS : 94V-2,94V-0
- ◆ COLOR : BLACK / NATURAL
- ◆ UNIT: mm

用途：扭式固定座,也称扭线固定座,背胶式,可快速拆卸,固定电线,捆扎及解开电线,装配容易,维修方便,整齐美观。

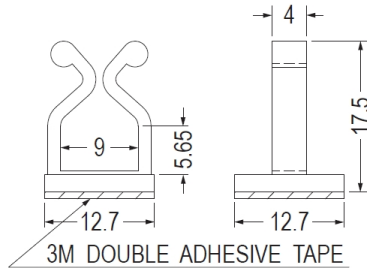

PART NO	PACKAGE
WS-T228	1000

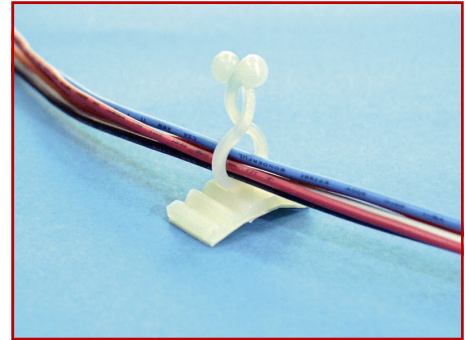
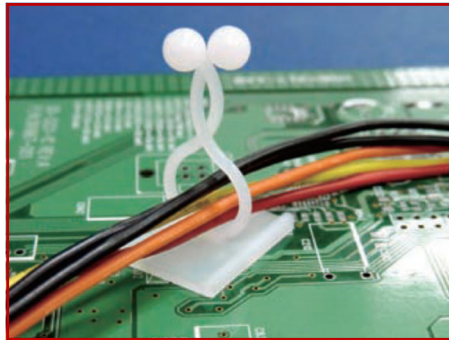
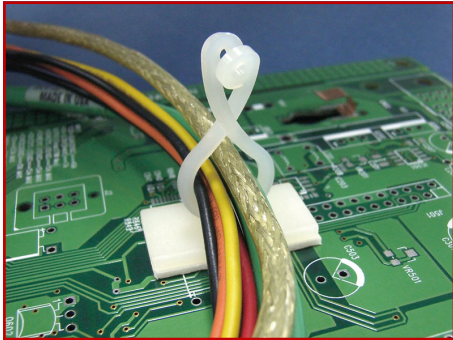

扭式固定座

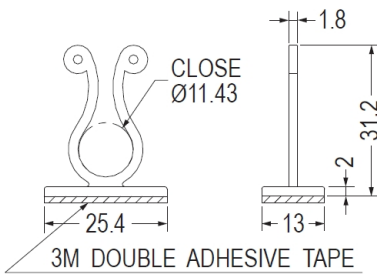

PART NO	PACKAGE
DH-22	500

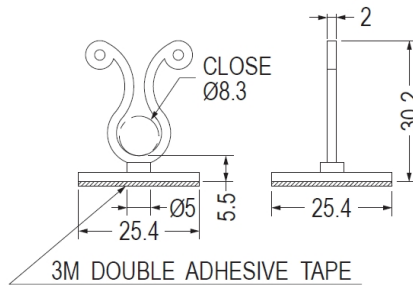

PART NO	PACKAGE
DH-25	250

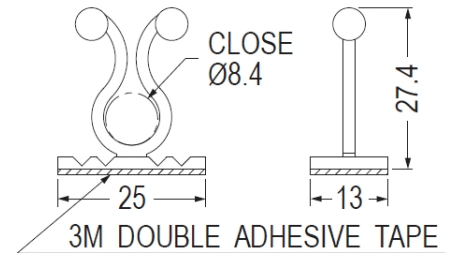

PART NO	PACKAGE
DH-21	500

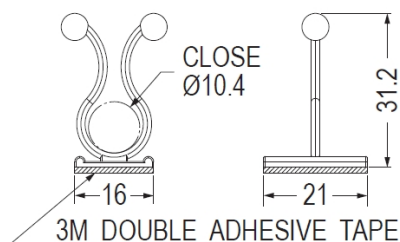
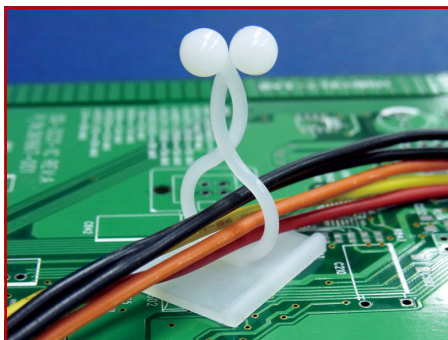

PART NO	PACKAGE
DH-23	500

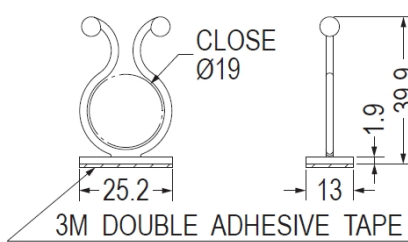

PART NO	PACKAGE
DH-24	500

扭式固定座 TWIST LOCK / TWIST TIES 扭线固定座 背胶式

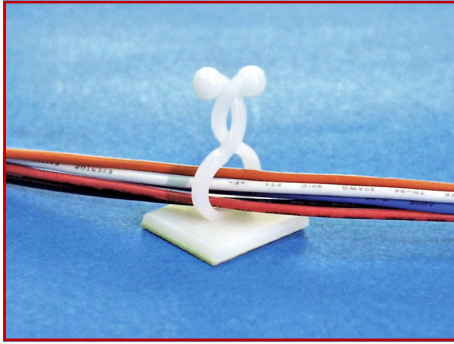

- ◆ MATERIAL : NYLON 66(UL)
- ◆ FLAME CLASS : 94V-2,94V-0
- ◆ COLOR : BLACK / NATURAL
- ◆ UNIT: mm

用途：扭式固定座,也称扭线固定座,背胶式,可快速捆扎及解开电线,装配容易。

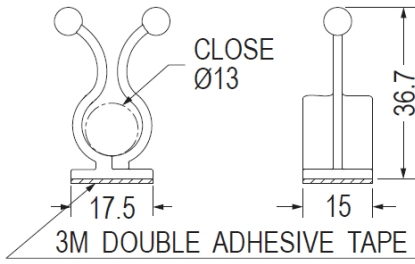
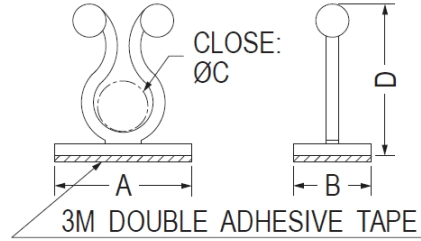

PART NO	PACKAGE
DH-79	250

PART NO	A	B	C	D	PACKAGE
DH-07	20.0	20.0	13.8	31.9	250
DH-08	20.0	14.0	8.5	26.2	500
DH-09	25.0	13.0	8.2	27.9	500
DH-10	21.0	19.0	10.0	28.2	500
DH-11	18.5	21.0	10.0	27.3	500
DH-12	38.0	20.0	34.0	56.2	100
DH-13	10.0	19.8	5.8	27.6	500
DH-14	20.0	13.0	7.2	21.9	500
DH-15	25.0	13.0	20.0	39.0	250
DH-16	25.0	13.0	20.0	39.0	250
DH-17	28.0	15.0	23.0	41.0	250
DH-18	25.0	20.0	13.2	34.7	250
DH-19	21.0	19.0	10.0	30.0	500
DH-20	22.1	13.0	17.0	37.0	250
DH-77	24.9	17.9	18.0	38.0	250

扭式固定座

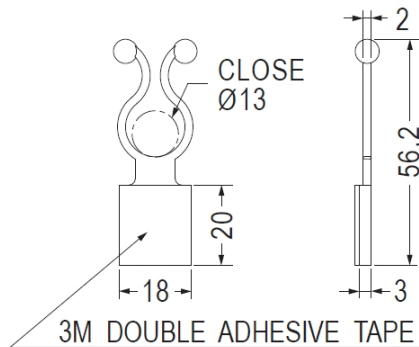

PART NO	PACKAGE
WS-T838	1000

扭式固定环 TWIST LOCK / TWIST TIES 扭线环

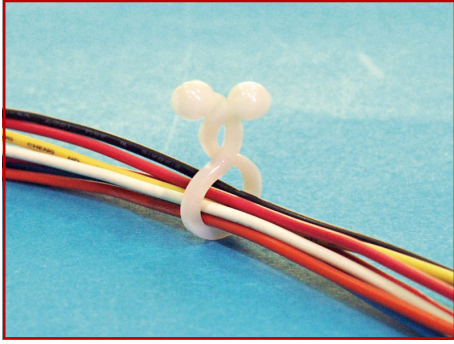

- ◆ MATERIAL : NYLON 66(UL)
- ◆ FLAME CLASS : 94V-2,94V-0
- ◆ COLOR : BLACK / NATURAL
- ◆ UNIT: mm

用途：扭式固定环,也称扭线环,用于配线中,有快速捆扎及解开之优点,可重复使用。

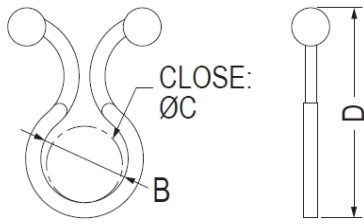

PART NO	B	C	D	PACKAGE
DXL-12	5.1	4.0	17.8	1000
DXL-13	8.3	7.3	23.8	1000
DXL-14	11.5	10.0	27.5	1000
DXL-15	15.4	13.8	30.4	1000
DXL-16	18.8	17.2	35.0	1000
DXL-17	25.8	24.2	41.4	500
DXL-18	22.0	19.5	42.0	500
DXL-19	5.6	5.0	16.5	500
DXL-20	11.0	9.7	30.0	500
DXL-21	19.2	16.3	38.5	500
DXL-22	5.2	4.2	22.0	500

PART NO	B	C	D	PACKAGE
DXL-23	13.2	11.5	32.5	500
DXL-24	27.5	27.0	46.0	500
DXL-25	29.0	26.8	55.5	500
DXL-26	18.0	17.0	40.0	500
DXL-28	18.6	17.0	40.0	500
DXL-29	14.8	13.5	35.0	500
DXL-30	8.6	8.0	26.0	500
DXL-32	15.0	14.5	35.1	500
DXL-40	38.0	32.0	56.0	500
DXL-41	19.2	16.5	38.5	500
DXL-43	40.0	38.0	63.0	500

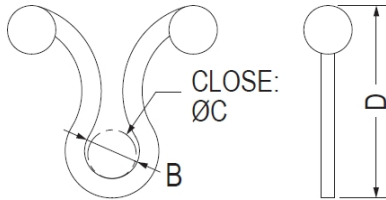

PART NO	B	C	D	PACKAGE
DXL-31	5.1	4.0	17.8	500
DXL-37	24.9	23.0	44.3	500
DXL-42	22.0	20.0	42.0	500

扭式固定环

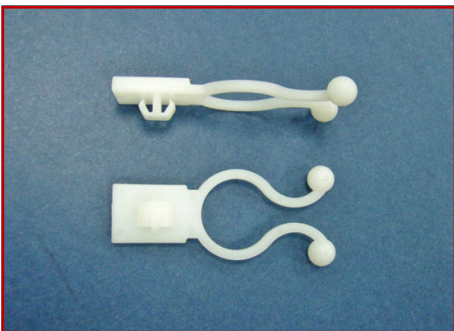

- ◆ MATERIAL : NYLON 66(UL)
- ◆ FLAME CLASS : 94V-2,94V-0
- ◆ COLOR : BLACK / NATURAL
- ◆ UNIT: mm

用途：扭式固定座,也称扭线固定座,可快速捆扎及解开电线,装配容易。

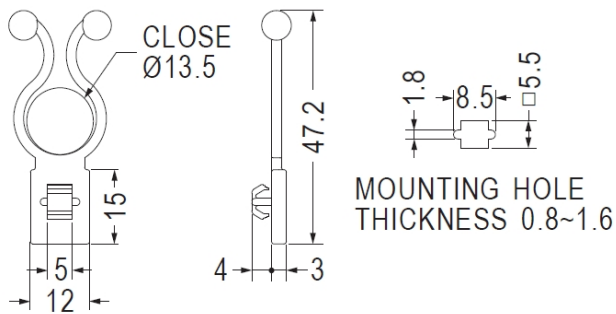

PART NO	PACKAGE
WS-T837	500

扭式固定座 TWIST LOCK / TWIST TIES 扭线固定座 背胶式

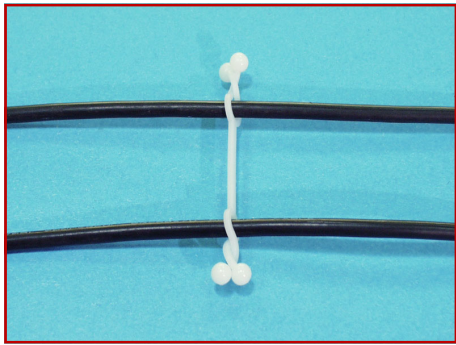

- ◆ MATERIAL : NYLON 66(UL)
- ◆ FLAME CLASS : 94V-2,94V-0
- ◆ COLOR : BLACK / NATURAL
- ◆ UNIT: mm

用途：扭式固定座,也称扭线固定座,用于电子内部电线固定,安装容易,美观不脱落。

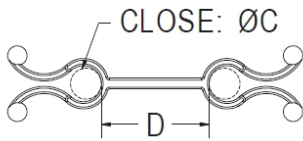
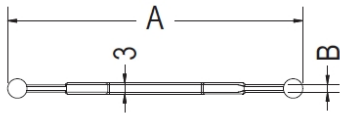
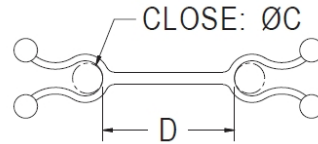
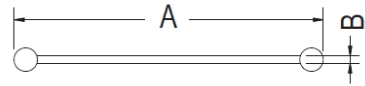

PART NO	A	B	C	D	PACKAGE
DXL-1	75.0	1.8	6.3	33.2	500
DXL-2	56.0	1.6	8.5	13.2	500

PART NO	A	B	C	D	PACKAGE
DXL-35	82.2	2.0	8.6	30.0	500

扭式固定座

扎带固定座 CABLE TIE MOUNT 扎线固定座

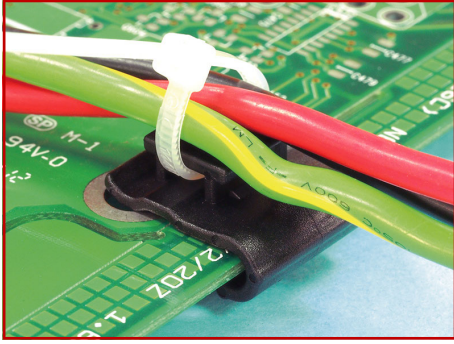

- ◆ MATERIAL : NYLON 66(UL)
- ◆ FLAME CLASS : 94V-2,94V-0
- ◆ COLOR : BLACK
- ◆ UNIT: mm

用途：扎带固定座,也称扎线固定座，固定于机板上，配合扎带使用，固定电线。

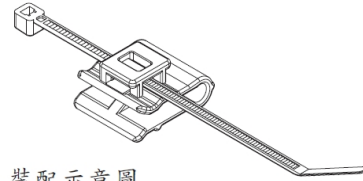
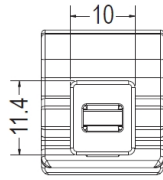

装配示意图

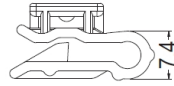
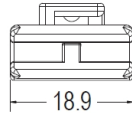

PART NO	PACKAGE
CCTH-35	500

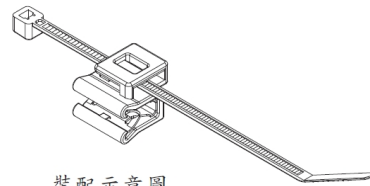
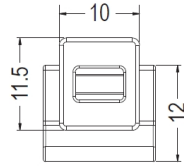
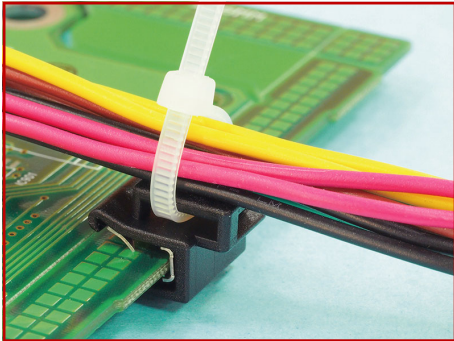

装配示意图

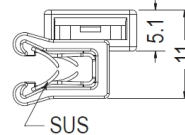
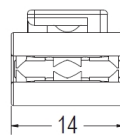

PART NO	PACKAGE
CCTH-42	1000

RECOMMEND SUITABLE THICKNESS 1.5-2.0

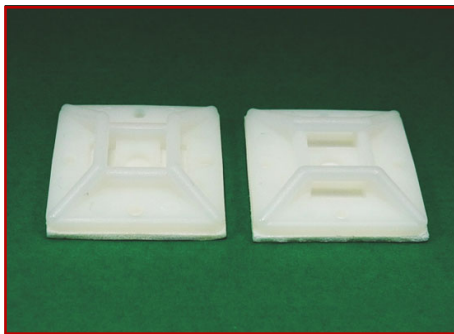

- ◆ MATERIAL : NYLON 66(UL)
- ◆ FLAME CLASS : 94V-2,94V-0
- ◆ COLOR : BLACK/NATURAL
- ◆ UNIT: mm

用途：扎带固定座,也称扎线固定座，配合扎带使用，固定电线，背胶式亦可配合螺丝，使机器内部走线美丽、整齐。

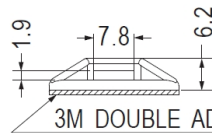
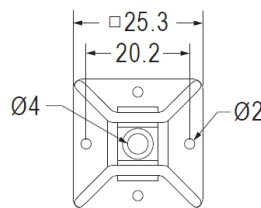

3M DOUBLE ADHESIVE TAPE

PART NO	PACKAGE
CCTH-9	500

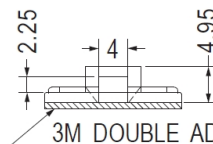
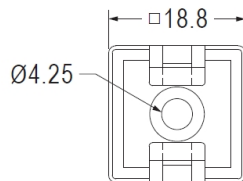
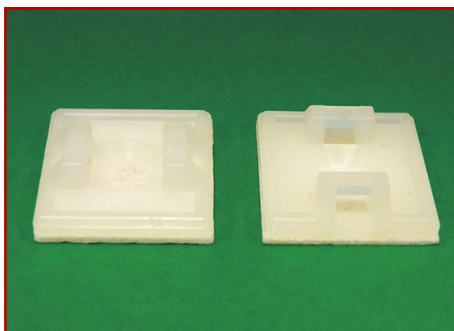

3M DOUBLE ADHESIVE TAPE

PART NO	PACKAGE
CCTH-16	1000

扎带固定座

扎带固定座 CABLE TIE MOUNT 扎线固定座

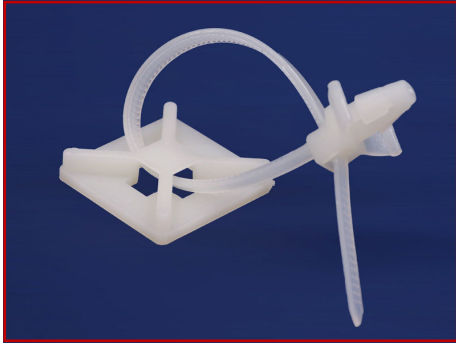

- ◆ MATERIAL : NYLON 66(UL)
- ◆ FLAME CLASS : 94V-2,94V-0
- ◆ COLOR : BLACK / NATURAL
- ◆ UNIT: mm

用途：扭式固定座,也称扭线固定座，配合扎带使用，固定电线，背胶式亦可配合螺丝，使机器内部走线美丽、整齐。

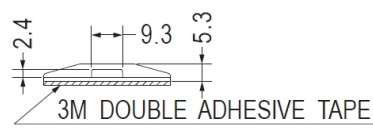
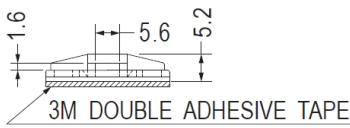
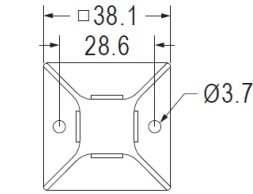
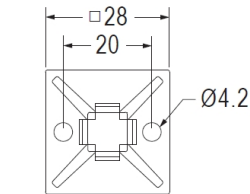
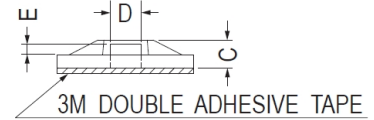
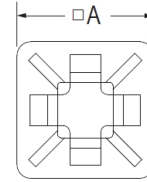

PART NO	PACKAGE
CCTH-15	250

PART NO	PACKAGE
CCTH-48	250

PART NO	A	C	D	E	PACKAGE
CCTH-10	13.0	3.2	3.2	1.3	1000
CCTH-11	16.0	4.0	3.8	1.5	1000
CCTH-12	19.1	4.0	4.0	1.6	500
CCTH-13	19.5	4.8	5.0	1.7	500
CCTH-14	20.0	4.3	4.8	1.6	500

扎带固定座

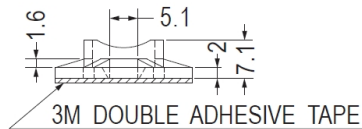
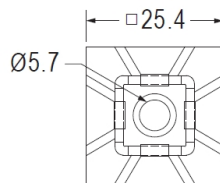

PART NO	PACKAGE
CCTH-19	250

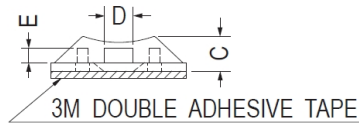
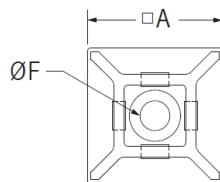
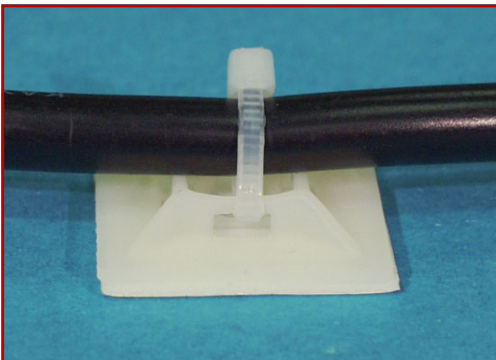

PART NO	A	C	D	E	F	PACKAGE
CCTH-17	19.0	5.0	4.0	1.9	3.0	500
CCTH-18	27.8	5.5	6.0	2.0	5.6	250
CCTH-49	19.0	5.0	4.0	2.0	4.2	500

扎带固定座 CABLE TIE MOUNT 扎线固定座

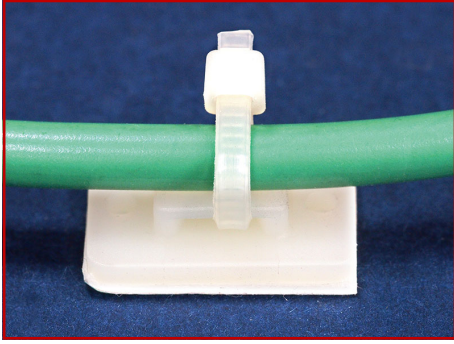

- ◆ MATERIAL : NYLON 66(UL)
- ◆ FLAME CLASS : 94V-2,94V-0
- ◆ COLOR : BLACK/NATURAL
- ◆ UNIT: mm

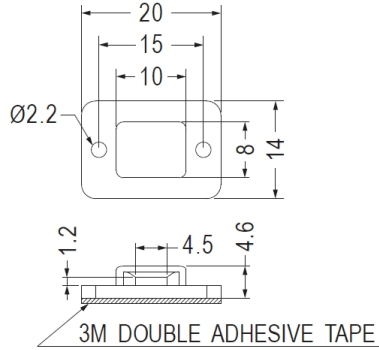

用途：扎带固定座,也称扎线固定座，配合扎带使用，固定电线，背胶式亦可配合螺丝，使机器内部走线美丽、整齐。

PART NO	PACKAGE
CCTH-36	1000

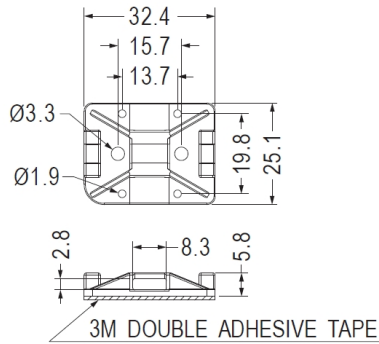
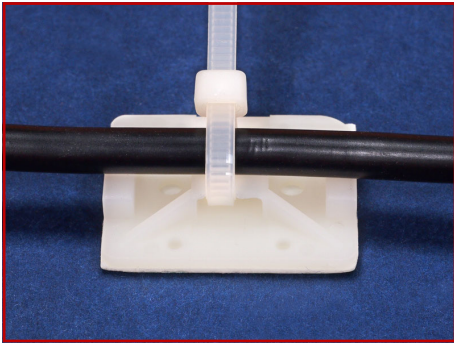

PART NO	PACKAGE
CCTH-20	250

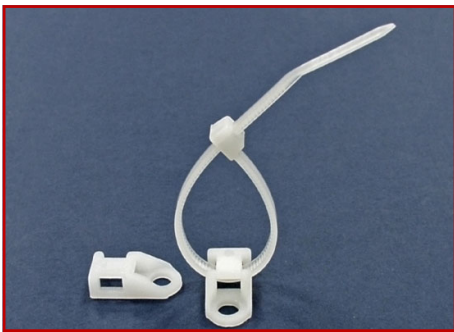

- ◆ MATERIAL : NYLON 66(UL)
- ◆ FLAME CLASS : 94V-2,94V-0
- ◆ COLOR : BLACK/NATURAL
- ◆ UNIT: mm

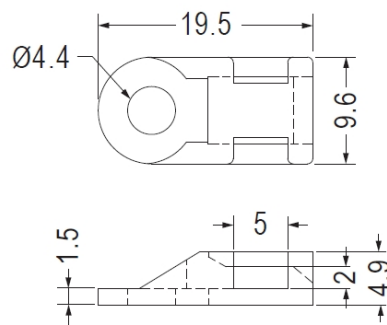

用途：扎带固定座,也称扎线固定座，用螺丝固定于机板上，配合扎带固定电线。

PART NO	PACKAGE
CCTH-21	1000

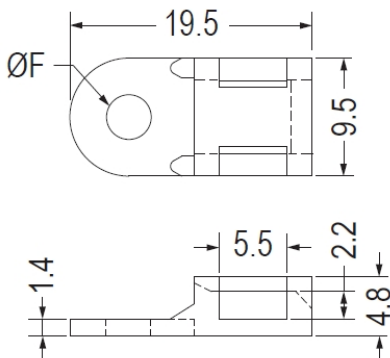
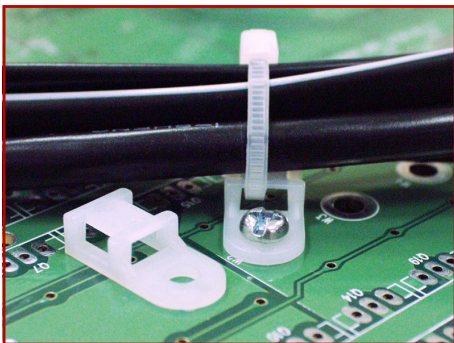

PART NO	F	PACKAGE
CCTH-24	3.6	1000
CCTH-37	4.7	1000

扎带固定座

扎带固定座 CABLE TIE MOUNT 扎线固定座

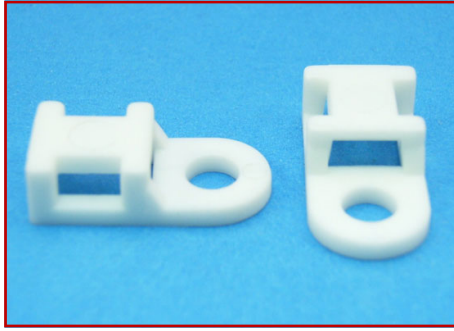

- ◆ MATERIAL : NYLON 66(UL)
- ◆ FLAME CLASS : 94V-2,94V-0
- ◆ COLOR : BLACK / NATURAL
- ◆ UNIT: mm

用途：扎带固定座,也称扎线固定座，用螺丝固定于机板上，配合扎带固定电线。

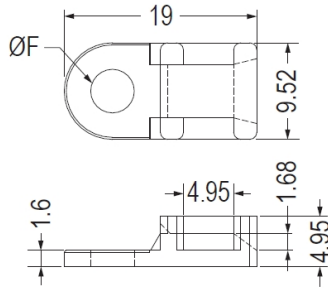

PART NO	F	PACKAGE
CCTH-25	4.3	1000
CCTH-38	6.5	1000

扎带固定座

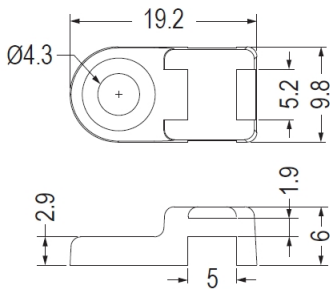
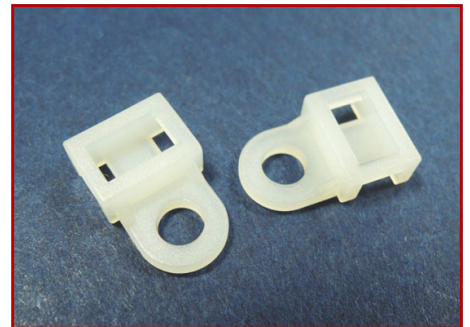

PART NO	PACKAGE
CCTH-26	1000

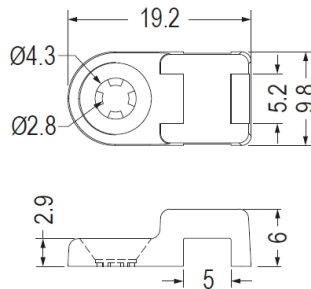

PART NO	PACKAGE
CCTH-40	1000

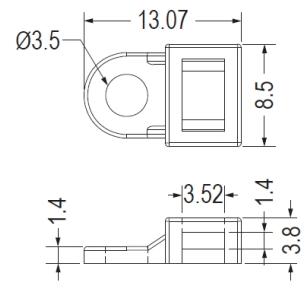

PART NO	PACKAGE
CCTH-39	1000

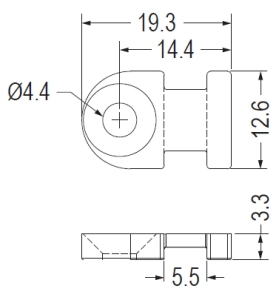
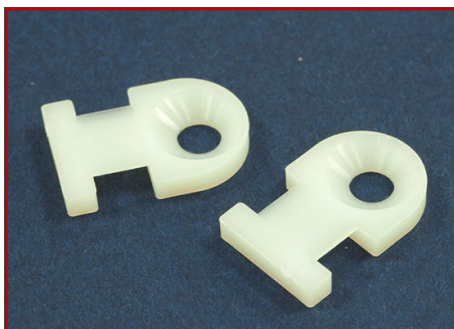

PART NO	PACKAGE
CCTH-44	1000

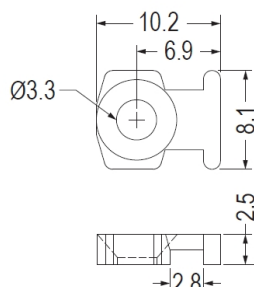

PART NO	PACKAGE
CCTH-45	1000

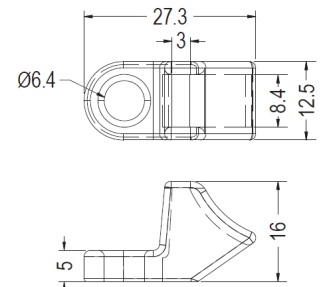

PART NO	PACKAGE
CCTH-27	1000

扎带固定座 CABLE TIE MOUNT 扎线固定座

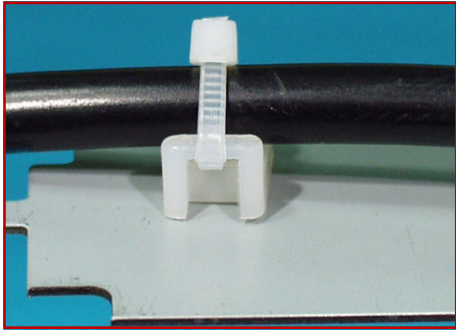

- ◆ MATERIAL : NYLON 66(UL)
- ◆ FLAME CLASS : 94V-2,94V-0
- ◆ COLOR : BLACK/NATURAL
- ◆ UNIT: mm

用途：扎带固定座,也称扎线固定座，用螺丝固定于机板上，配合扎带固定电线。

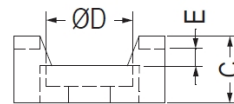
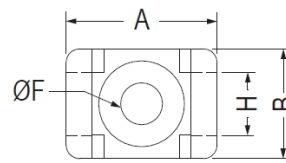
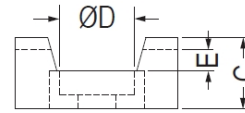
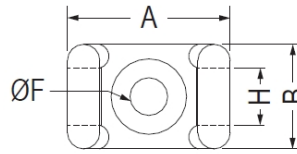

PART NO	A	B	C	D	E	F	H	PACKAGE
CCTH-22	15.2	9.7	6.6	6.9	2.0	3.5	5.2	1000
CCTH-23	13.3	8.2	5.85	5.9	1.75	3.2	3.6	1000

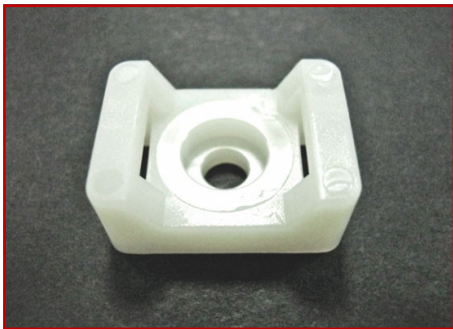

PART NO	A	B	C	D	E	F	H	PACKAGE
CCTH-30	14.9	9.6	7.2	7.8	1.5	3.7	5.6	1000
CCTH-31	14.9	9.6	7.2	7.8	1.5	4.5	5.6	1000
CCTH-32	22.0	16.0	9.6	8.0	2.3	4.5	9.2	500
CCTH-33	22.0	16.0	9.6	9.6	2.3	4.8	9.2	500
CCTH-34	22.0	16.0	9.6	12.7	2.3	6.4	9.2	500



- ◆ MATERIAL : NYLON 66(UL)
- ◆ FLAME CLASS : 94V-2,94V-0
- ◆ COLOR : BLACK/NATURAL
- ◆ UNIT: mm

用途：扎带固定座,也称扎线固定座，用螺丝或背胶固定于机板上，配合扎带固定电线。

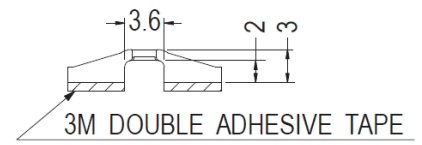
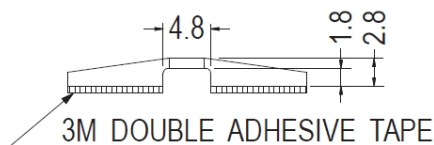
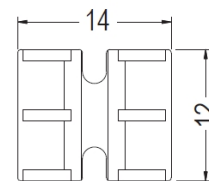
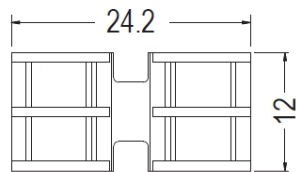

PART NO	PACKAGE
CCTH-28	1000

PART NO	PACKAGE
CCTH-29	1000

扎带固定座 CABLE TIE MOUNT 扎线固定座



- ◆ MATERIAL : NYLON 66(UL)
- ◆ FLAME CLASS : 94V-2,94V-0
- ◆ COLOR : BLACK / NATURAL
- ◆ UNIT: mm

用途：扎带固定座,也称扎线固定座，配合扎带固定电线于机壳上，方便安装，强韧牢固。

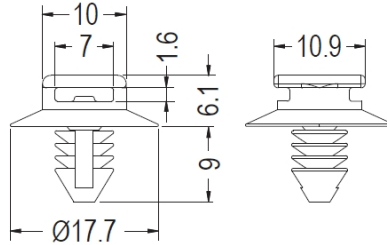

MOUNTING HOLE Ø6.0
THICKNESS 0.8~9.0

PART NO	PACKAGE
CCTH-4	1000

扎带固定座

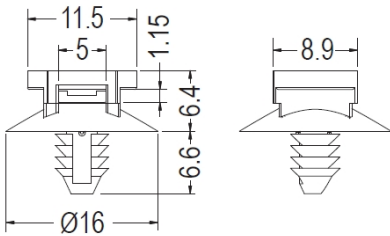
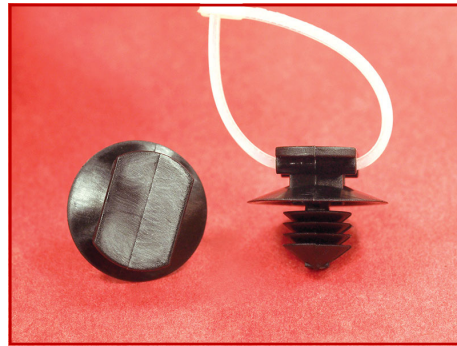
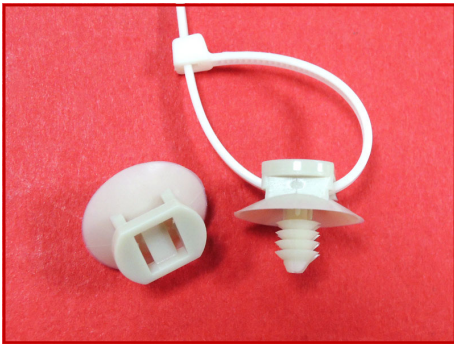

MOUNTING HOLE Ø4.5~Ø5.0
THICKNESS 0.8~7.0

PART NO	PACKAGE
CCTH-43	1000

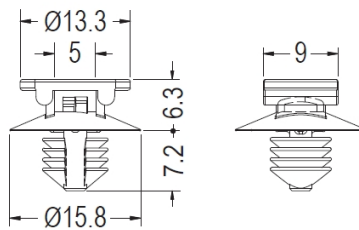

MOUNTING HOLE Ø6.5~Ø7.0
THICKNESS 0.8~3.0

PART NO	PACKAGE
CCTH-46	1000

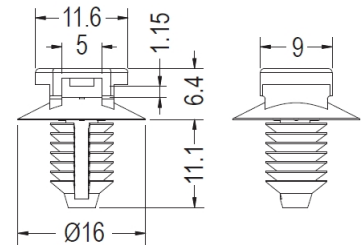

MOUNTING HOLE Ø6.4~Ø7.1
THICKNESS 0.8~6.0

PART NO	PACKAGE
CCTH-47	1000

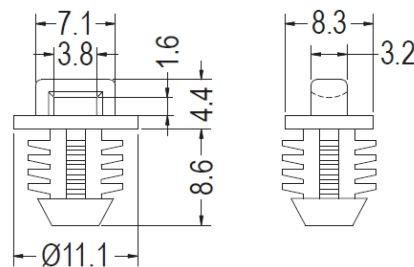

CHASSIS Ø7.9
THICKNESS 6.4

PART NO	PACKAGE
CCTH-3	1000

扎带固定座 CABLE TIE MOUNT 扎线固定座

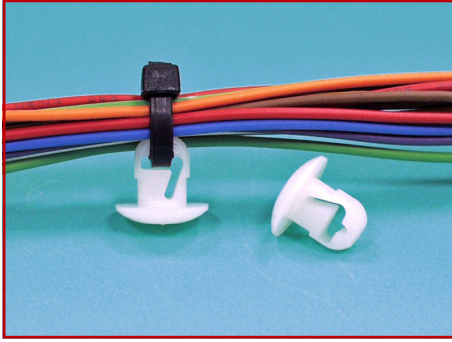

- ◆ MATERIAL : NYLON 66(UL)
- ◆ FLAME CLASS : 94V-2,94V-0
- ◆ COLOR : BLACK/NATURAL
- ◆ UNIT: mm

用途： 扎带固定座,也称扎线固定座，配合扎带固定电线于机壳上，方便安装，强韧牢固。

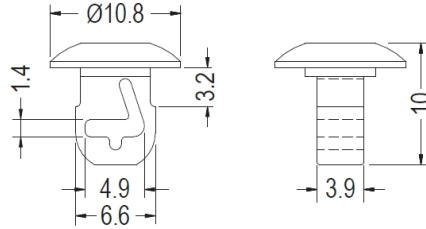

CHASSIS Ø6.4

PART NO	PACKAGE
CCTH-1	1000

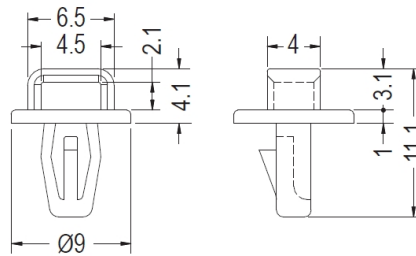

MOUNTING HOLE Ø4.0
THICKNESS 1.6~2.0

PART NO	PACKAGE
CCTH-5	1000

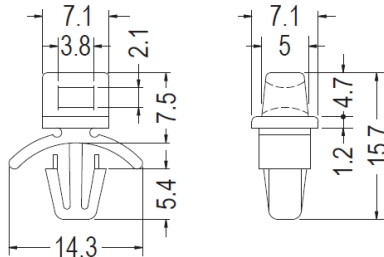

MOUNTING HOLE Ø4.8
THICKNESS 0.8~2.0

PART NO	PACKAGE
CCTH-2	1000

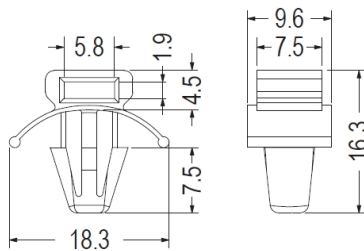
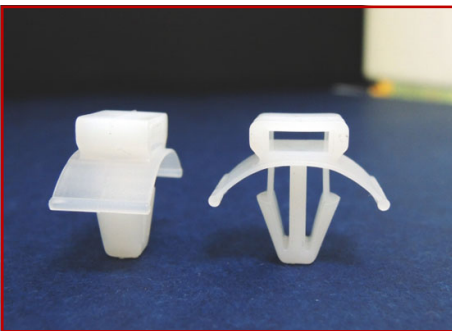

MOUNTING HOLE Ø6.2~Ø6.3
THICKNESS 0.8~3.6

PART NO	PACKAGE
CCTH-41	1000

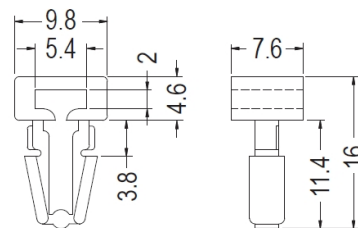

PANEL HOLE DIA Ø6.4
PANEL THICKNESS 3.17

PART NO	PACKAGE
CCTH-6	1000

扎带固定座

扎带固定座 CABLE TIE MOUNT 扎线固定座

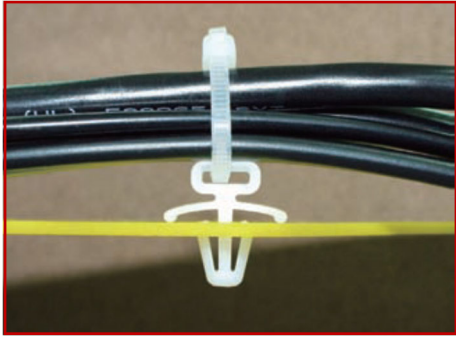

- ◆ MATERIAL : NYLON 66(UL)
- ◆ FLAME CLASS : 94V-2,94V-0
- ◆ COLOR : BLACK / NATURAL
- ◆ UNIT: mm

用途：扎带固定座,也称扎线固定座，配合扎带固定电线于机壳上，方便安装，强韧牢固。

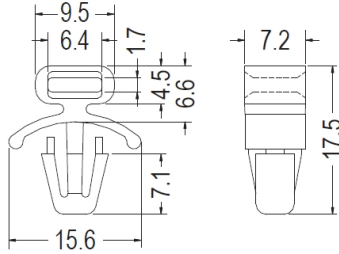

MOUNTING HOLE Ø6.4
THICKNESS 1.2-2.8

PART NO	PACKAGE
CCTH-7	1000

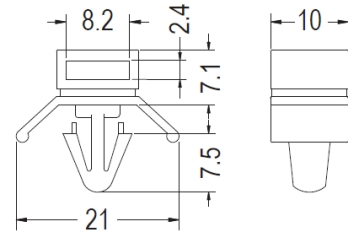

MOUNTING HOLE Ø6.2
THICKNESS 0.8-3.2

PART NO	PACKAGE
CCTH-8	1000

扎带固定座

电源线固定座 POWER CORD RETENTION CLAMP

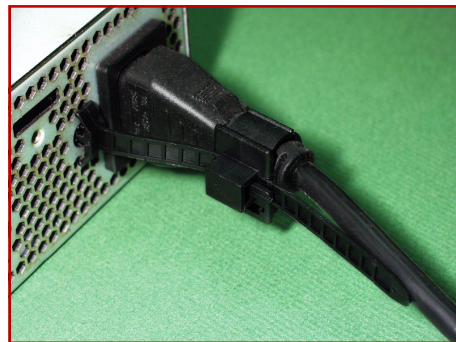

- ◆ MATERIAL : NYLON 66(UL)
- ◆ FLAME CLASS : 94V-2,94V-0
- ◆ COLOR : BLACK
- ◆ UNIT: mm

用途：电源线固定座,可固定电源线，避免因不小心脱落，造成计算机停机。

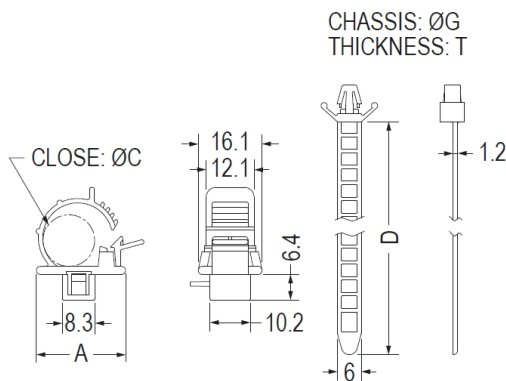

WS-T426



WS-T558

PART NO	A	C	D	G	T	PACKAGE
WS-T004	22.5	11.0~13.0	86.75	4.8	0.8~2.0	100
WS-T011	22.5	12.0~15.0	86.75	4.8	0.8~2.0	100
WS-T012	22.5	11.0~13.0	86.75	3.5	0.8~2.0	100
WS-T003	29.5	19.0~22.0	86.75	4.8	0.8~2.0	100
WS-T426	22.5	11.0~13.0	86.75	4.0	0.8~2.0	100
WS-T558	22.5	12.0~15.0	86.75	4.8	0.6~1.8	100
WS-T664	22.5	11.0~13.0	112.5	4.8	0.8~2.0	100

CHASSIS Ø4.8
THICKNESS 0.8~1.6

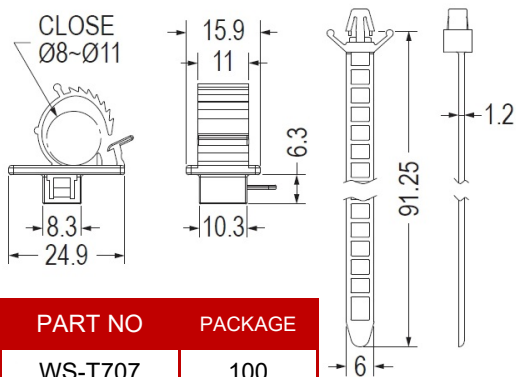

PART NO	PACKAGE
WS-T707	100

CHASSIS Ø4.8
THICKNESS 0.8~2.0

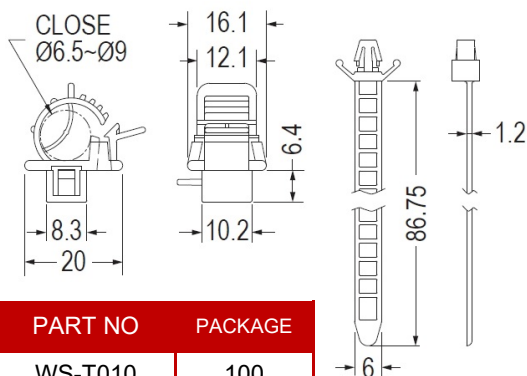

PART NO	PACKAGE
WS-T010	100

CHASSIS Ø3.5
THICKNESS 0.8~2.0

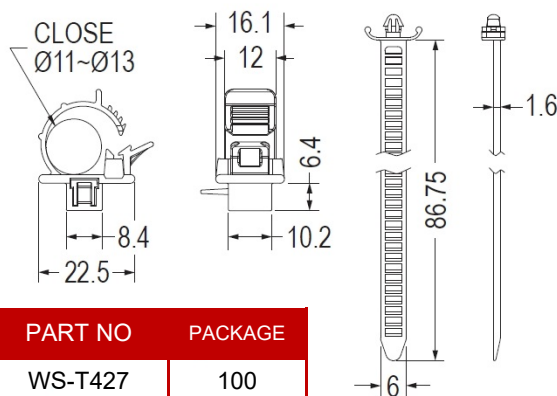

PART NO	PACKAGE
WS-T427	100

电源线固定座 POWER CORD RETENTION CLAMP

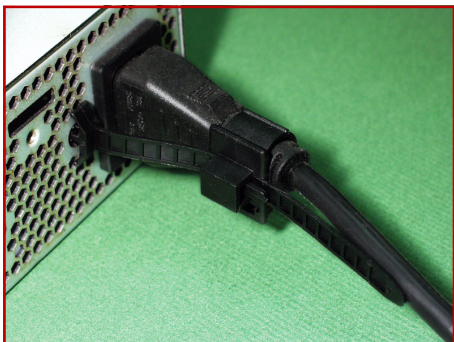

- ◆ MATERIAL : NYLON 66(UL)
- ◆ FLAME CLASS : 94V-2,94V-0
- ◆ COLOR : BLACK
- ◆ UNIT: mm

用途：电源线固定座,可固定电源线,避免不小心脱落,造成计算机停机。

电源线固定座

MOUNTING HOLE THICKNESS 0.8~1.4

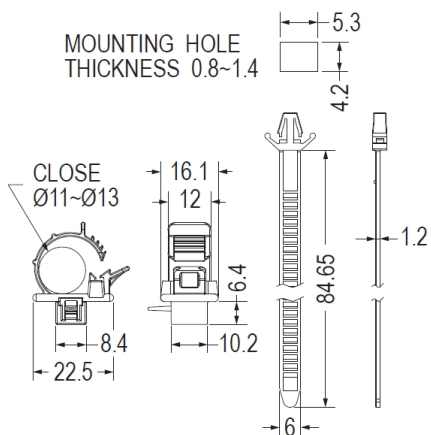

PART NO	PACKAGE
WS-T008	100

CHASSIS Ø3.5 THICKNESS 0.8~2.0

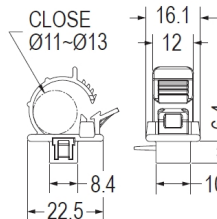
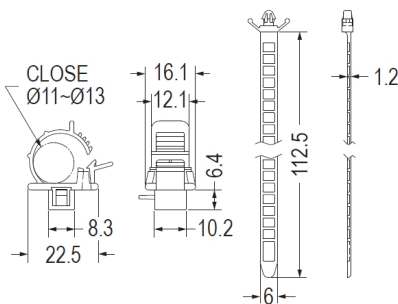

PART NO	PACKAGE
WS-T708	100

CHASSIS Ø4.8 THICKNESS 0.8~2.0

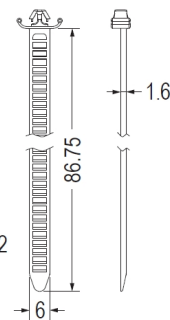

PART NO PACKAGE

WS-T710 100

MOUNTING HOLE THICKNESS 0.8

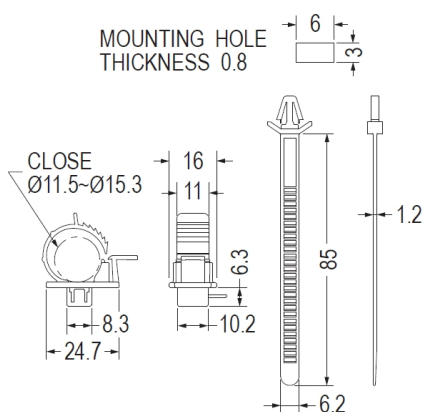

PART NO	PACKAGE
WS-T557	100

CHASSIS Ø4.8-Ø5.0 THICKNESS 0.8~2.0

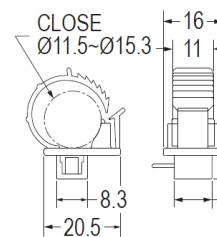
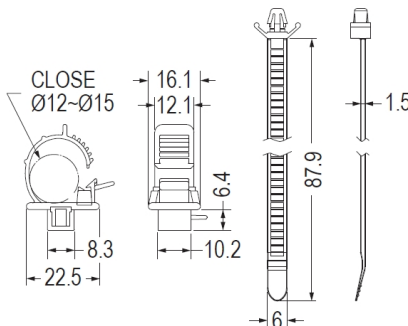

PART NO	PACKAGE
WS-T634	100

CHASSIS Ø3.5 THICKNESS 0.8~2.0

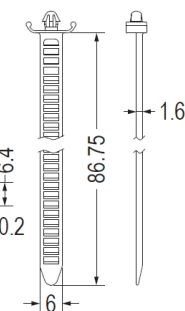

PART NO PACKAGE

WS-T711 100

CHASSIS Ø3.5 THICKNESS 0.8

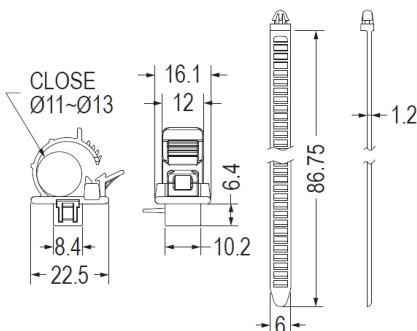

PART NO	PACKAGE
WS-T556	100

CHASSIS Ø5.0 THICKNESS 0.5~2.0

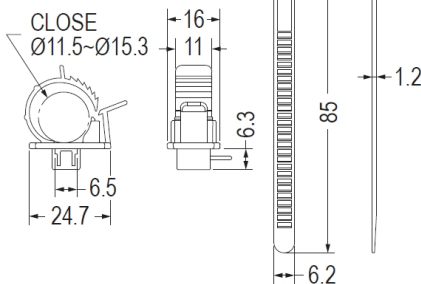

MOUNTING CHASSIS THICKNESS 0.8~2.0

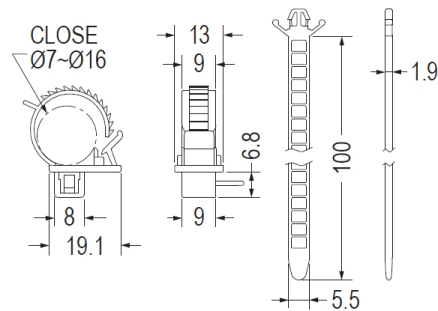

PART NO	PACKAGE
WS-T709	100

PART NO PACKAGE

WS-T630 100

电源线固定座 POWER CORD RETENTION CLAMP



- ◆ MATERIAL : NYLON 66(UL)
- ◆ FLAME CLASS : 94V-2,94V-0
- ◆ COLOR : BLACK
- ◆ UNIT: mm

用途：电源线固定座,可固定电源线，避免因不小心脱落，造成计算机停机。

CHASSIS: ØG
THICKNESS: T

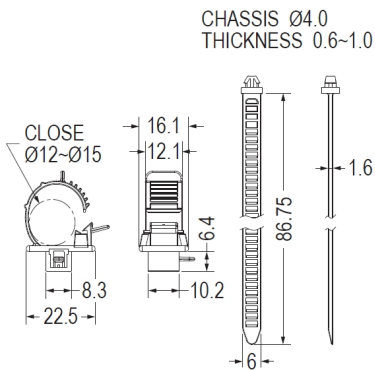

PART NO	PACKAGE
WS-T665	100

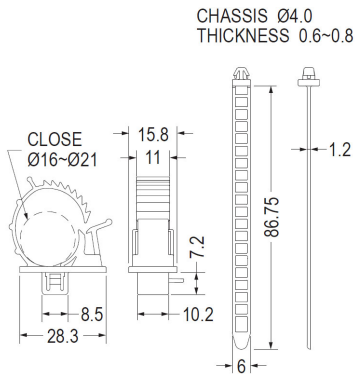

PART NO	PACKAGE
WS-T911	100

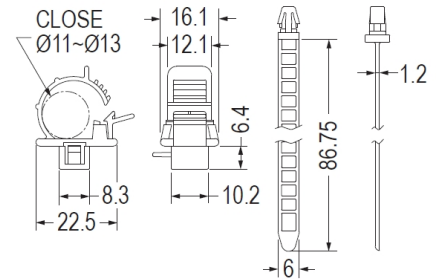

PART NO	G	T	PACKAGE
WS-T006	4.8	2.0~3.0	100
WS-T007	4.0	0.6~0.8	100
WS-T423	4.8	0.6~1.2	100



MOUNTING HOLE: ØG
THICKNESS 1.8

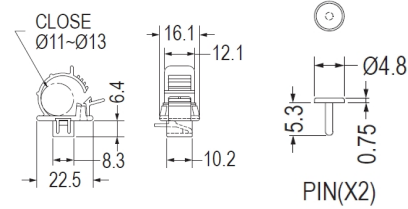
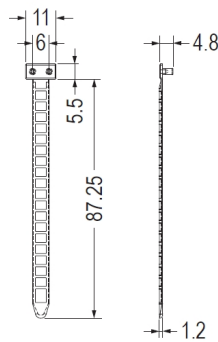

PART NO	G	PACKAGE
WS-T005	2.3	100
WS-T425	2.5	100

MOUNTING HOLE Ø3.5
THICKNESS 2.0-2.8

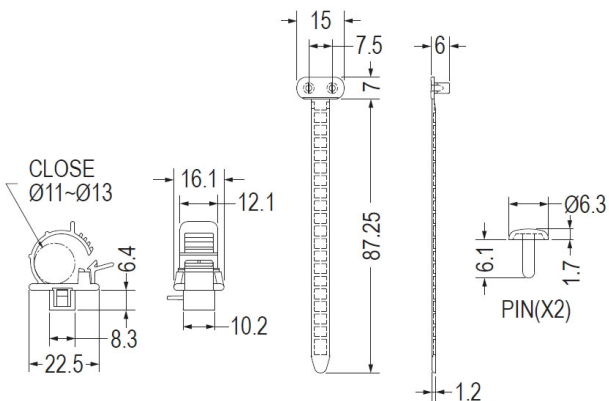

PART NO	PACKAGE
WS-T712	100

Ø2.3(X2) 6 MOUNTING HOLE
THICKNESS 1.8

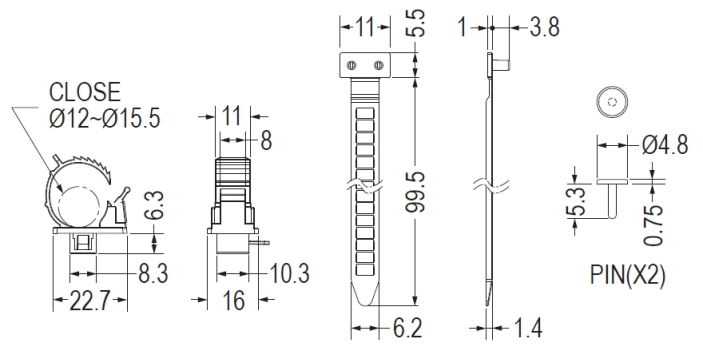

PART NO	PACKAGE
WS-T666	100

电源线固定座 POWER CORD RETENTION CLAMP

电源线固定座

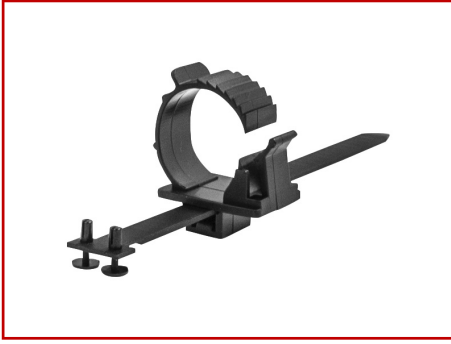

- ◆ MATERIAL : NYLON 66(UL)
- ◆ FLAME CLASS : 94V-2,94V-0
- ◆ COLOR : BLACK
- ◆ UNIT: mm

用途：电源线固定座,可固定电源线，避免因不小心脱落，造成计算机停机。

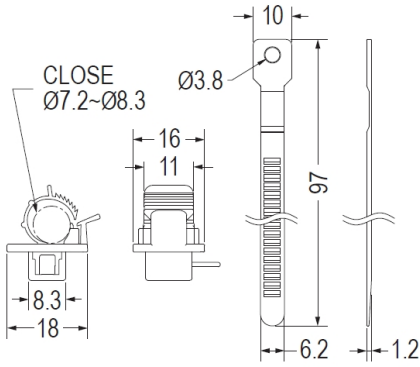

PART NO	PACKAGE
WS-T635	100

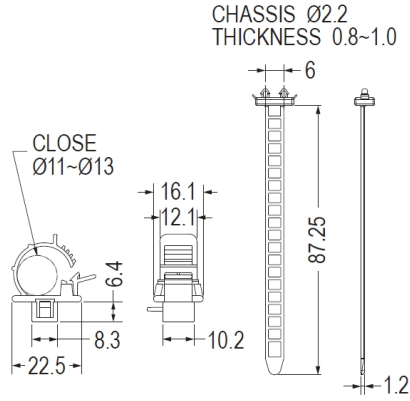

PART NO	PACKAGE
WS-T518	100

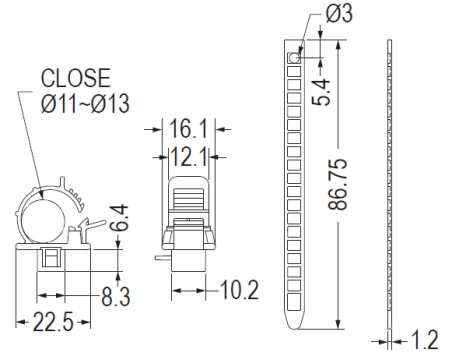

PART NO	PACKAGE
WS-T424	100

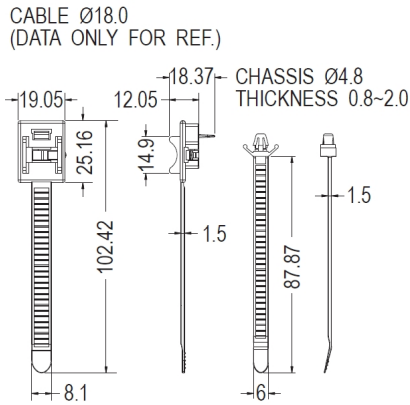

PART NO	PACKAGE
WS-T001	100

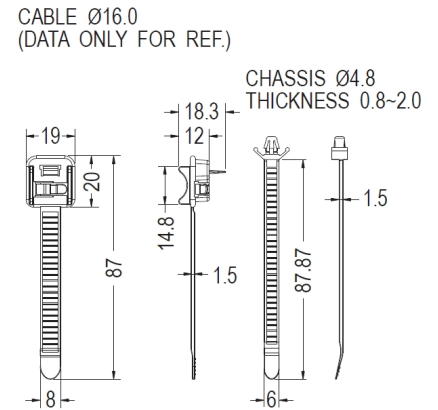

PART NO	PACKAGE
WS-T002	100

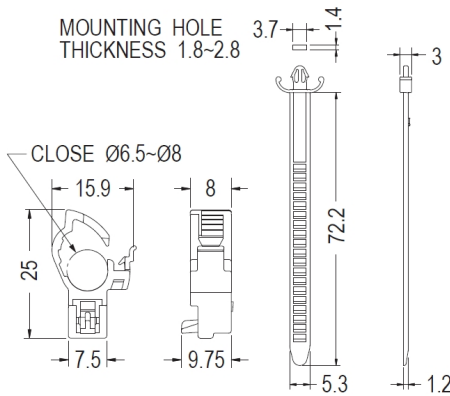

PART NO	PACKAGE
WS-T634	100

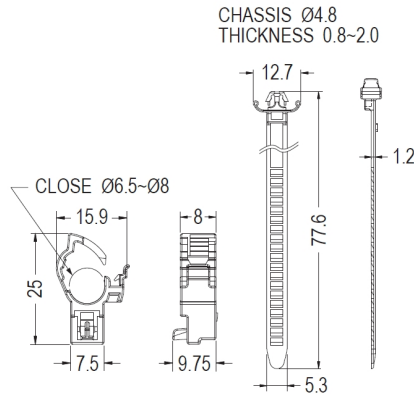

PART NO	PACKAGE
WS-T631	100

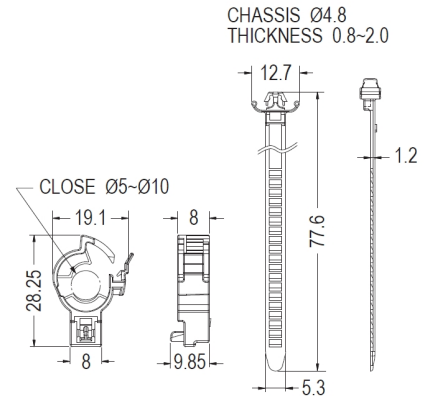

PART NO	PACKAGE
WS-T632	100

电源线固定座 POWER CORD RETENTION CLAMP



- ◆ MATERIAL : NYLON 66(UL)
- ◆ FLAME CLASS : 94V-2,94V-0
- ◆ COLOR : BLACK
- ◆ UNIT: mm

用途：电源线固定座,可固定电源线,避免不小心脱落,造成计算机停机。

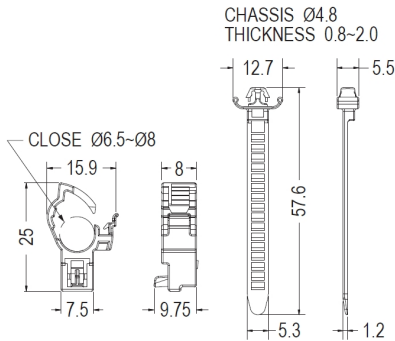

PART NO	PACKAGE
WS-T667	500

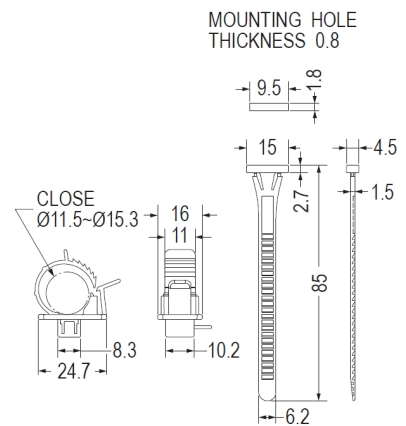
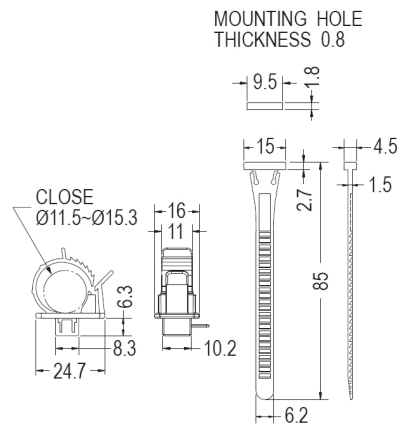

PART NO	PACKAGE
WS-T009	100

PART NO	PACKAGE
WS-T636	100

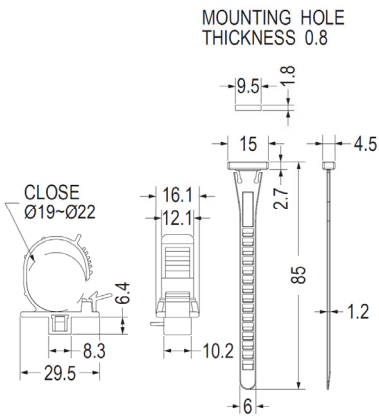

PART NO	PACKAGE
WS-T912	100

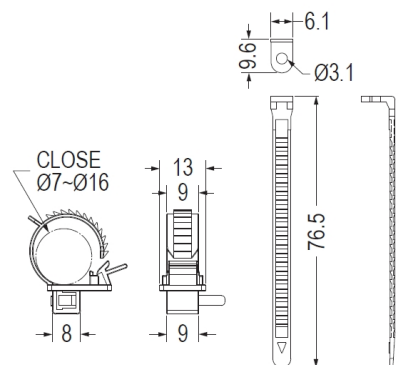
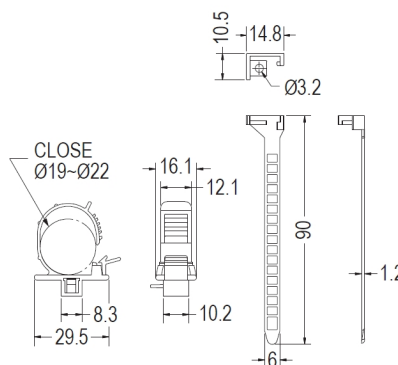

PART NO	PACKAGE
WS-T555	100

PART NO	PACKAGE
WS-T713	100

电源线固定座

电源线固定座 POWER CORD RETENTION CLAMP

电源线固定座

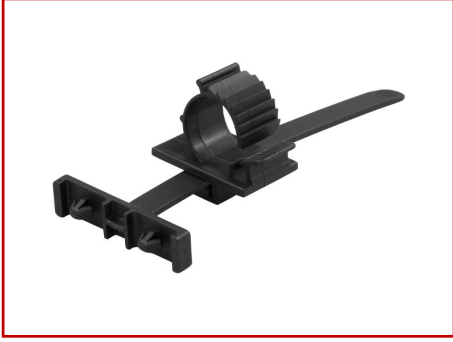

- ◆ MATERIAL : NYLON 66(UL)
- ◆ FLAME CLASS : 94V-2,94V-0
- ◆ COLOR : BLACK
- ◆ UNIT: mm

用途: 电源线固定座,可固定电源线,避免不小心脱落,造成计算机停机。

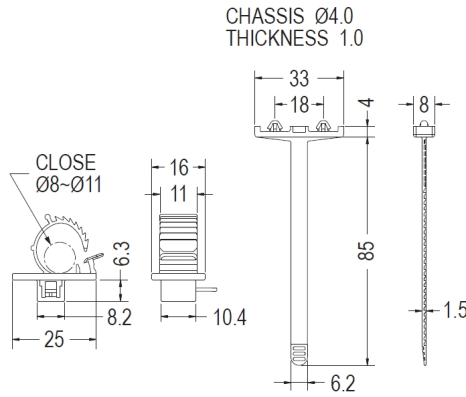

PART NO	PACKAGE
WS-T543	100

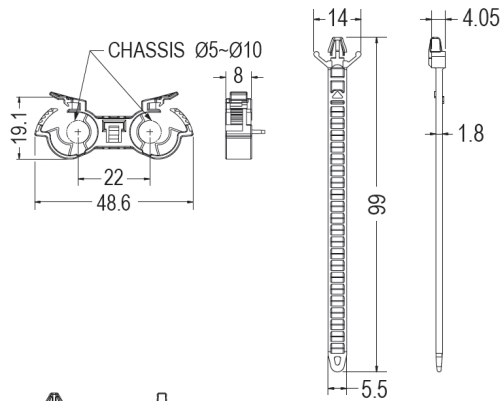

PART NO	PACKAGE
WS-T668	100

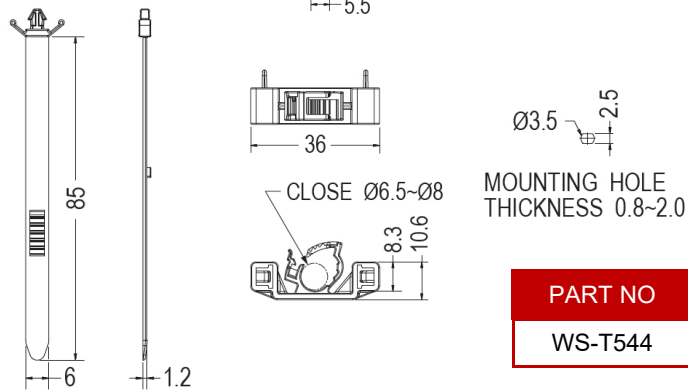

PART NO	PACKAGE
WS-T544	100

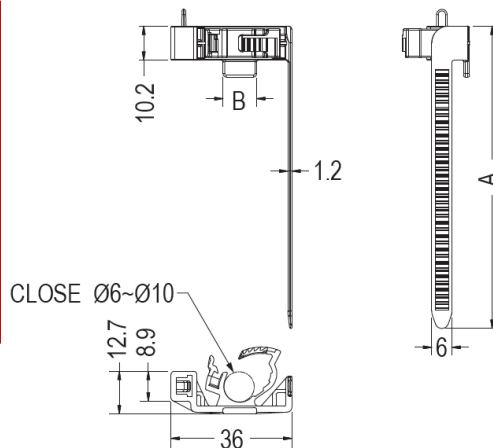
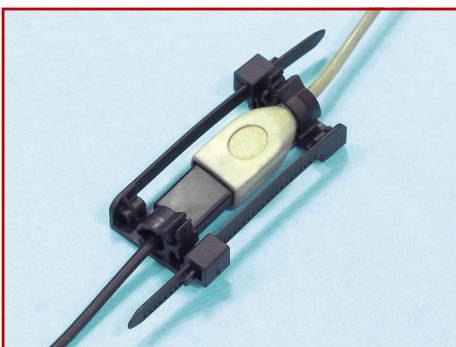

用途: 固定电源线、USB...等, 中间对接延长, 避免脱落。

PART NO	A	B	PACKAGE
WS-T545	90.17	10.0	100
WS-T553	90.2	-	100
WS-T554	115.2	10.0	100

电源线固定座 POWER CORD RETENTION CLAMP

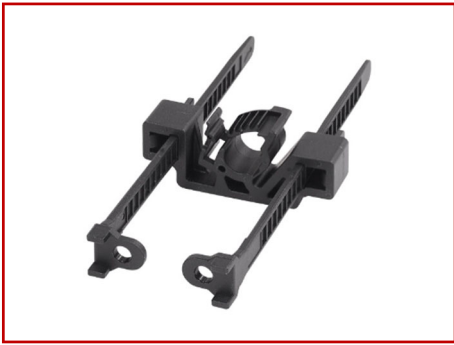

- ◆ MATERIAL : NYLON 66(UL)
- ◆ FLAME CLASS : 94V-2,94V-0
- ◆ COLOR : BLACK
- ◆ UNIT: mm

用途：电源线固定座,固定电源线、USB...等，中间对接延长，避免脱落。

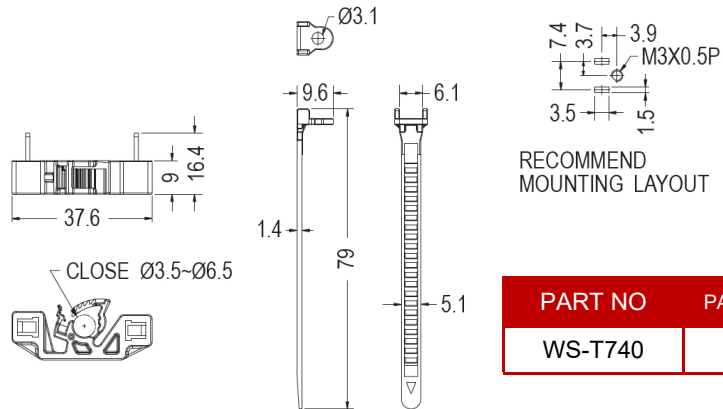

PART NO	PACKAGE
WS-T740	100

插头固定座 MOUNT

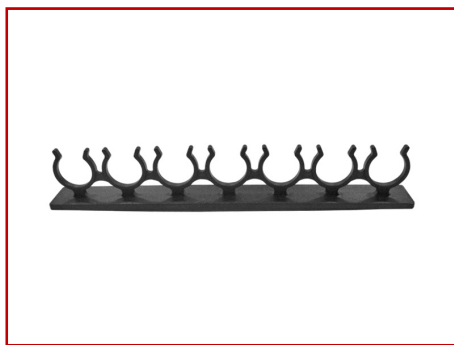

- ◆ MATERIAL : PP
- ◆ COLOR : BLACK
- ◆ UNIT: mm

用途：插头固定座,可快速拆卸，固定插头。

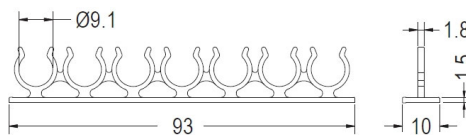

PART NO	PACKAGE
SCG-01	100

电线插座固定座 POWER PLUG MOUNT

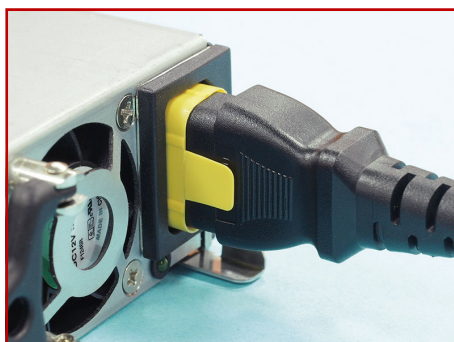

- ◆ MATERIAL : NYLON 66(UL)
- ◆ FLAME CLASS : 94V-2,94V-0
- ◆ COLOR : BLACK/NATURAL/RED/
BLUE/YELLOW/GREEN
- ◆ UNIT: mm

用途：电线插座固定座,避免电源插座脱落。

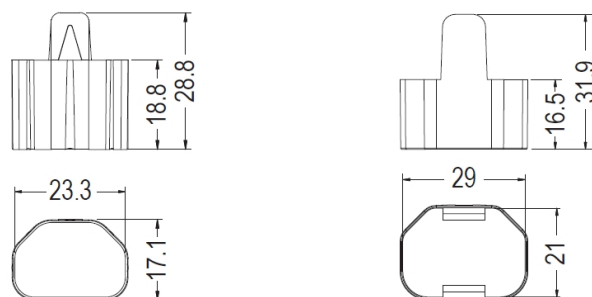

PART NO	PACKAGE
SWA-1	1000

PART NO	PACKAGE
SWA-2	1000

电源线固定座插头固定扣 SOCKET MOUNT

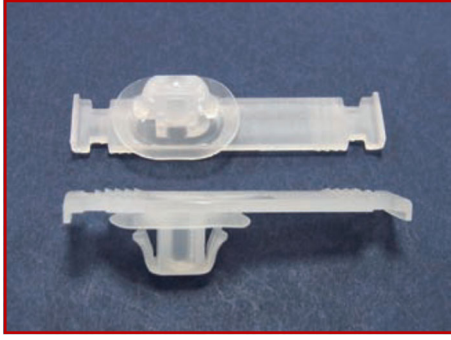

- ◆ MATERIAL : PP(UL)
- ◆ FLAME CLASS : 94VHB
- ◆ COLOR : BLACK/NATURAL
- ◆ UNIT: mm

用途：插头固定扣,配合扎带固定电线于机壳上,方便安装,强韧牢固。

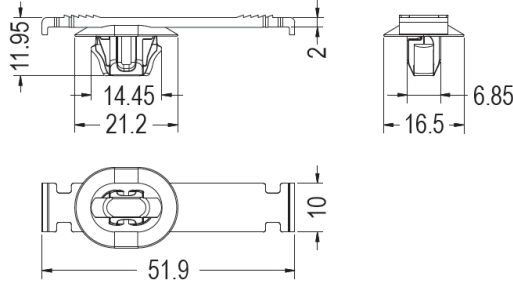

PART NO	PACKAGE
YJ-G01	500

电源线固定座

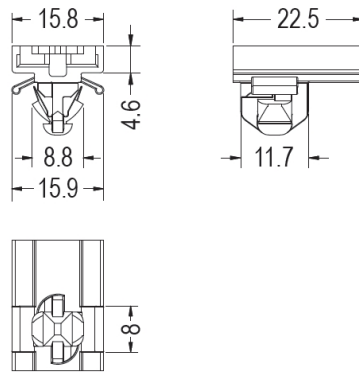

PART NO	PACKAGE
YJ-G02	500

C13 AC电源扣件 AC POWER RETAINER C 13



- ◆ MATERIAL : NYLON 66(UL)
- ◆ FLAME CLASS : 94V-2/94V-2
- ◆ COLOR : GRAY
- ◆ UNIT: mm

用途：C13 AC电源扣件可固定电源线,避免不小心脱落,造成电脑停机。

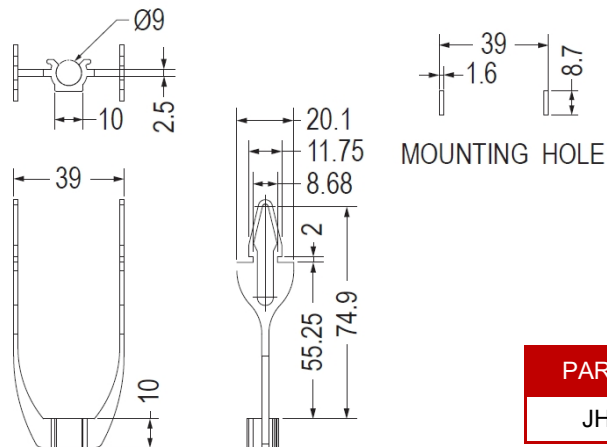

PART NO	PACKAGE
JHK-5	250

天线固定座 ANTENNA MOUNT 配线固定座

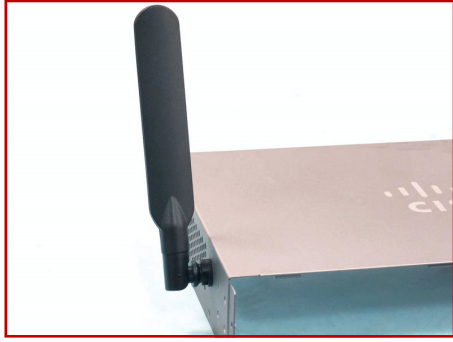

- ◆ MATERIAL : NYLON 66(UL)
- ◆ FLAME CLASS : 94V-2,94V-0
- ◆ COLOR : BLACK/NATURAL
- ◆ UNIT: mm

用途: 天线固定座,用于机顶盒或路由器WI-FI天线之固定。

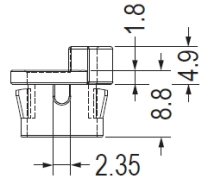
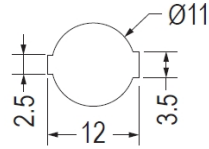
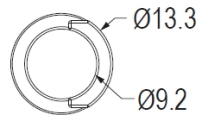

MOUNTING HOLE THICKNESS 0.6

PART NO	PACKAGE
TX-1	1000

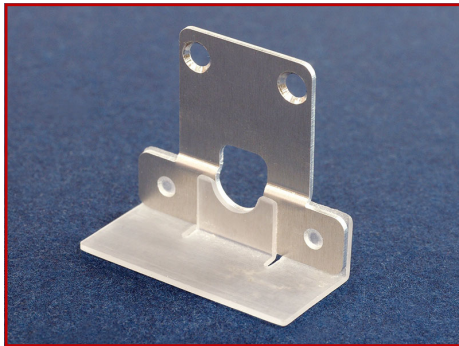

- ◆ MATERIAL : NYLON 66(UL)
- ◆ FLAME CLASS : 94V-2,94V-0
- ◆ COLOR : BLACK/NATURAL
- ◆ UNIT: mm

用途: 天线固定座 用于天线之固定与保护。

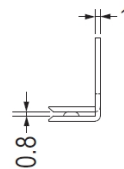
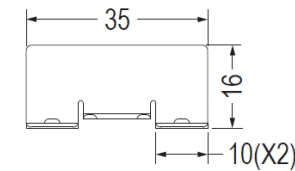
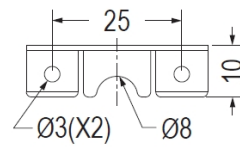

PART NO	PACKAGE
TX-2	1000

T8固定座 T8 MOUNT 配线固定座

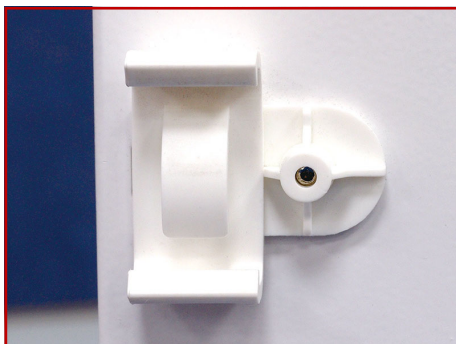

- ◆ MATERIAL : NYLON 66(UL)
- ◆ FLAME CLASS : 94V-2,94V-0
- ◆ COLOR : BLACK/NATURAL
- ◆ UNIT: mm

用途: T8固定座,用于轻钢架之固定网络天线。

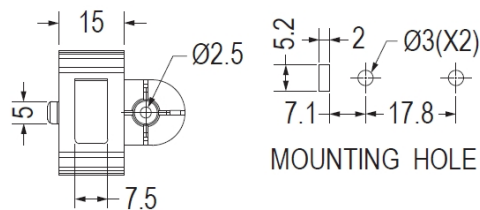

MOUNTING HOLE

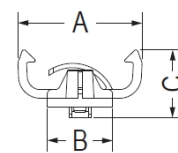
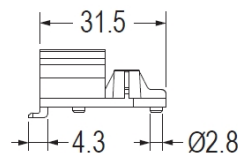

PART NO	A	B	C	PACKAGE
T8G-04	18.3	8.0	14.1	500
T8G-05	28.5	15.0	15.5	500
T8G-06	42.85	15.0	15.5	250

T8灯管固定座 T8 LAMP MOUNT



- ◆ MATERIAL : NYLON 66(UL)
- ◆ FLAME CLASS : 94V-2,94V-0
- ◆ COLOR : BLACK/NATURAL
- ◆ UNIT: mm

用途: T8灯管固定座,可固定T8 LED灯管或电线使用。

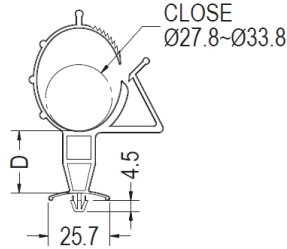

CHASSIS Ø5.5
THICKNESS 1.0~1.2

PART NO	A	PACKAGE
T8G-01	26.0	50
T8G-02	9.0	100
T8G-03	26.0	50

风扇束线座 FAN CABLE TIE MOUNT

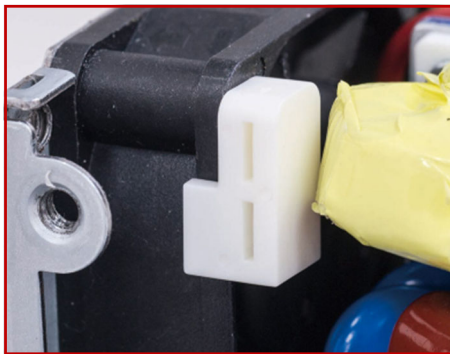

- ◆ MATERIAL : NYLON 66(UL)
- ◆ FLAME CLASS : 94V-2,94V-0
- ◆ COLOR : BLACK/NATURAL
- ◆ UNIT: mm

用途: 风扇束线座,风扇电线之固定,整齐美观。

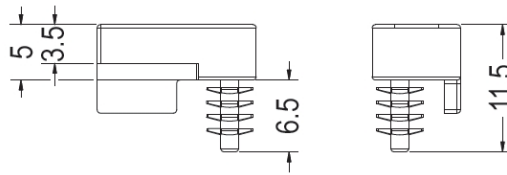

HOLE IN P.C.B Ø3.5

PART NO	PACKAGE
LWKM-3	1000

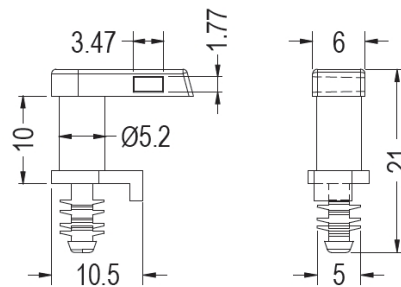

CHASSIS Ø4.4

PART NO	PACKAGE
LWKM-1	500

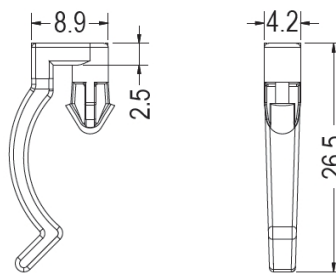

MOUNTING HOLE Ø4.3
CHASSIS THICKNESS Ø4.0

PART NO	PACKAGE
LWKM-2	1000

HDMI固定座 HDMI MOUNT

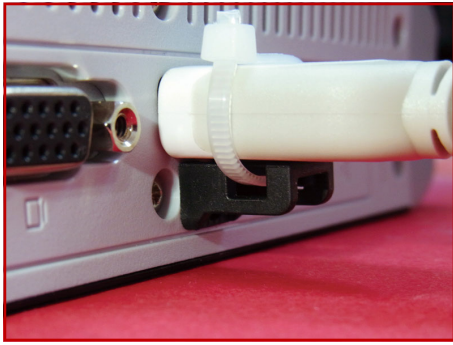

- ◆ MATERIAL : NYLON 66(UL)
- ◆ FLAME CLASS : 94V-2,94V-0
- ◆ COLOR : BLACK
- ◆ UNIT: mm

用途: HDMI固定座,配合螺丝、扎带,使用于USB、HDMI等线材端子,固定于机壳上,避免勾到脱落。

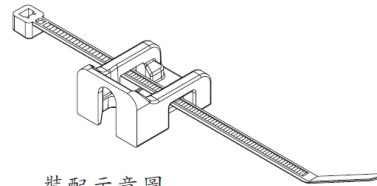
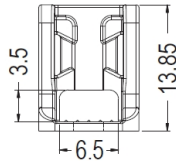

装配示意图

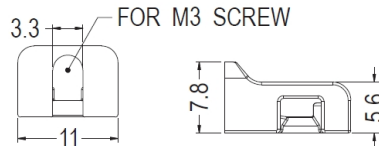

PART NO	PACKAGE
HDMI-1	1000

防落下固定带 ANTI-EARTHQUAKE FASTENER

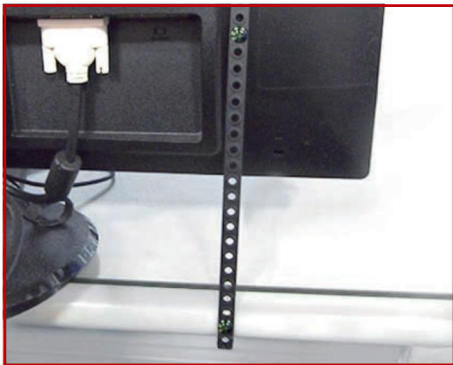

- ◆ MATERIAL : NYLON 66(UL)
- ◆ FLAME CLASS : 94V-2,94V-0
- ◆ COLOR : BLACK/NATURAL
- ◆ UNIT: mm

用途: 防落下固定带,预防LCD-TV于地震时落下,固定物件用。

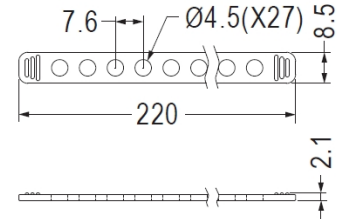
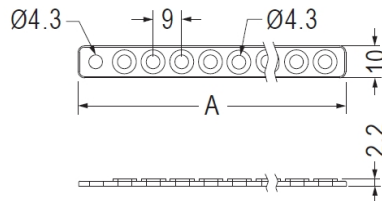

PART NO	A	POLES	PACKAGE
CHD-01	172.75	19.0	500
CHD-02	210.0	22.0	500

PART NO	PACKAGE
CHD-03	500

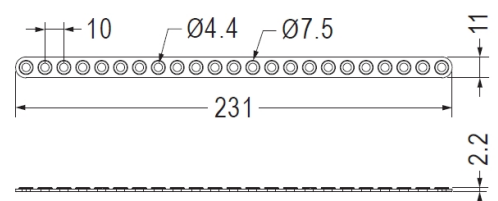
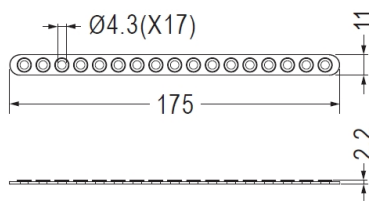

PART NO	PACKAGE
CHD-05	500

- ◆ MATERIAL : PP
- ◆ COLOR : BLACK
- ◆ UNIT: mm

PART NO	PACKAGE
CHD-04	500

光纤固定座 FIBER CABLE HOUSING

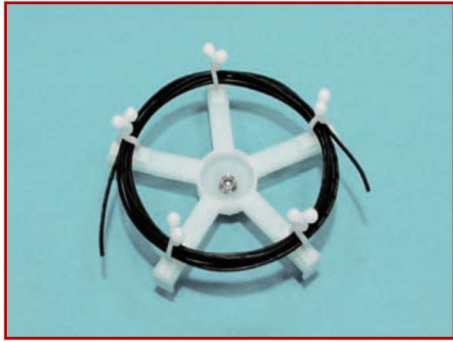

- ◆ MATERIAL : NYLON 66(UL)
- ◆ FLAME CLASS : 94V-2
- ◆ COLOR : NATUAL
- ◆ UNIT: mm

用途：光纤固定座,配合扭线固定座系列产品使用,可固定光纤,不折断,不衰减。

PART NO	FITTING	PACKAGE
FCHO-1	SCREW	50
FCHO-2	ADHESIVE	50

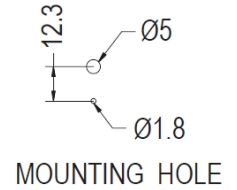
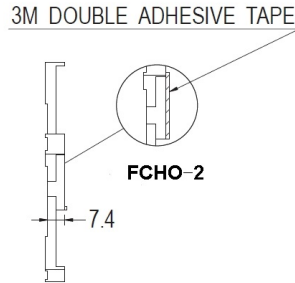
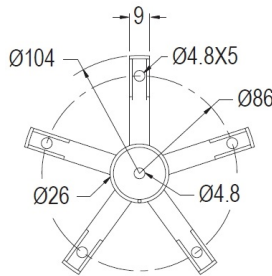

固定座



- ◆ MATERIAL : NYLON 66(UL)
- ◆ FLAME CLASS : 94V-2
- ◆ COLOR : NATUAL
- ◆ UNIT: mm

用途：光纤固定座,配合WS-T843~845产品使用,可固定光纤,不折断,不衰减。

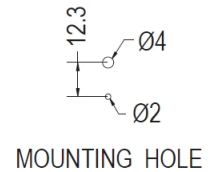
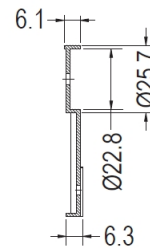
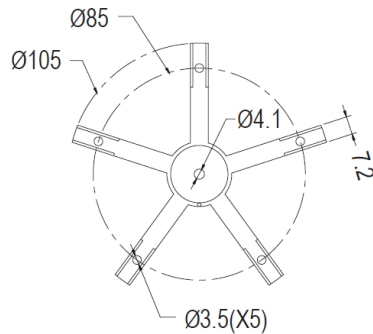

PART NO	PACKAGE
FCHO-3	50



- ◆ MATERIAL : NYLON 66(UL)
- ◆ FLAME CLASS : 94V-2
- ◆ COLOR : NATUAL
- ◆ UNIT: mm

用途：光纤固定座,螺丝固定,保护和固定光纤,不折断,不衰减。

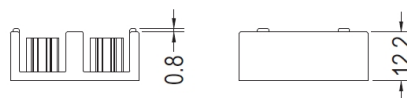
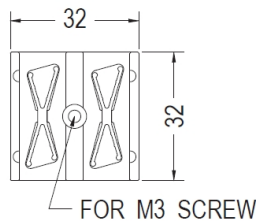

PART NO	PACKAGE
FCHO-4	50

防高压线环 F.B.T CLIP

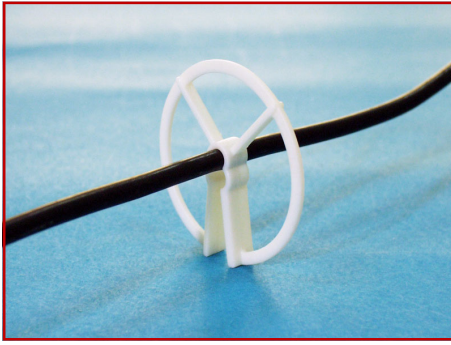

- ◆ MATERIAL : NYLON 66(UL)
- ◆ FLAME CLASS : 94V-2,94V-0
- ◆ COLOR : NATURAL
- ◆ UNIT: mm

用途：防高压线环,保护C.R.T.高压线与管壁间之绝缘使用方便。

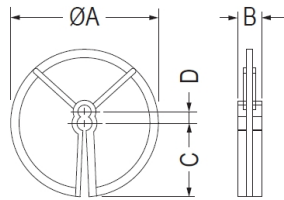

FIT CABLE: F

PART NO	A	B	C	D	F	PACKAGE
KFBT-01	49.5	7.8	22.0	5.0	4.5~5.3	100
KFBT-02	49.2	7.8	22.0	5.0	3.5~4.5	100
KFBT-03	50.2	7.4	23.0	5.0	2.5~3.5	100
KFBT-04	49.5	8.0	22.5	4.6	4.0~4.5 or	100
KFBT-05	49.2	8.0	22.0	4.7	3.7~4.2 or	100

WI-FI线固定座 WI-FI MOUNT 配线固定座

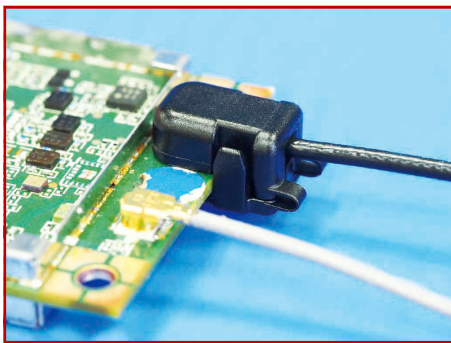

- ◆ MATERIAL : NYLON 66(UL)
- ◆ FLAME CLASS : 94V-2,94V-0
- ◆ COLOR : BLACK
- ◆ UNIT: mm

用途：WI-FI线固定座,配线固定座,用于WI-FI天线固定,避免脱落。

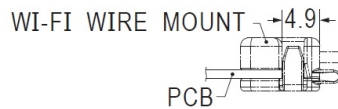
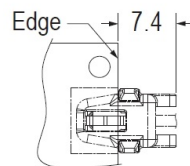

RECOMMEND THICKNESS 1.0

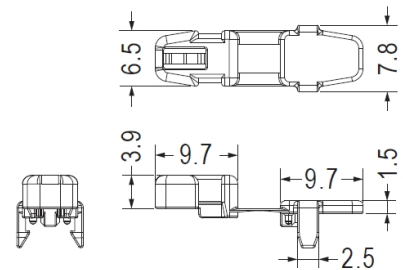

PART NO	PACKAGE
WIFI-1	1000

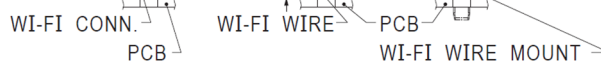
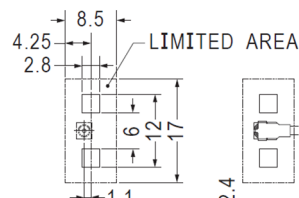

RECOMMEND MOUNTING HOLE
RECOMMEND THICKNESS 1.6

RECOMMEND MOUNTING LAYOUT

PART NO	PACKAGE
WIFI-2	1000

天线束线座 WIRE MOUNT 配线固定座

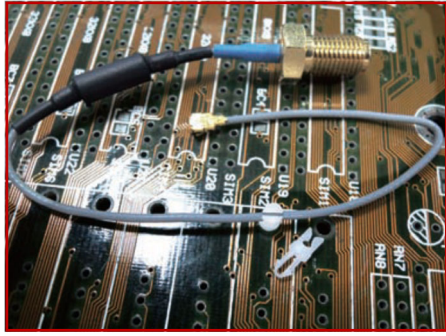

- ◆ MATERIAL : NYLON 66(UL)
- ◆ FLAME CLASS : 94V-2/94V-0
- ◆ COLOR : NATUAL/BLACK
- ◆ UNIT: mm

用途：天线束线座,将电线固定于机壳上, 电线不易磨损, 配线整齐美观。

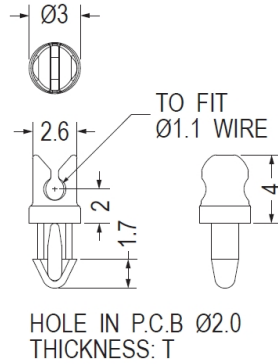

PART NO	T	PACKAGE
CHB-1	1.6~2.0	2000
CHB-2	1.0~1.2	2000
CHB-3	0.8	2000

天线束线座

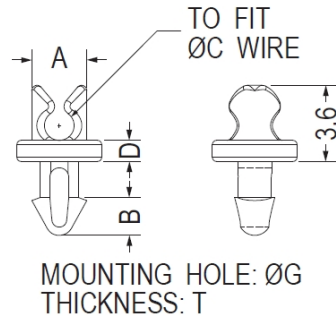
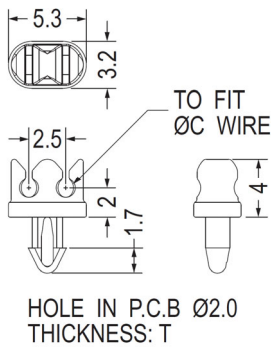
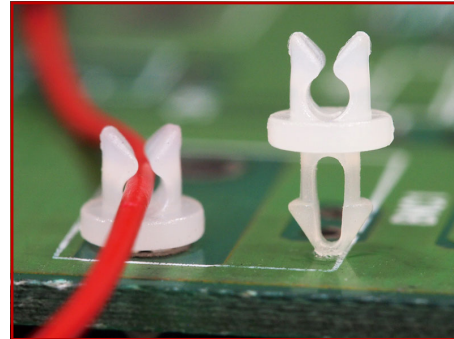
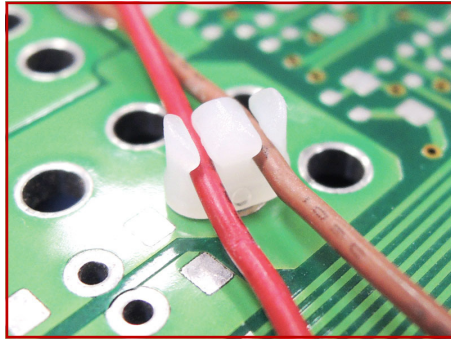

PART NO	C	T	PACKAGE
CHB-4	1.1	1.6~2.0	2000
CHB-5	1.1	0.8	2000
CHB-12	1.37	1.2	2000

PART NO	A	B	C	D	G	T	PACKAGE
CHB-9	2.6	1.8	1.37	1.0	2.0	1.6	2000
CHB-10	2.8	1.7	1.4	0.9	1.8	1.2	200

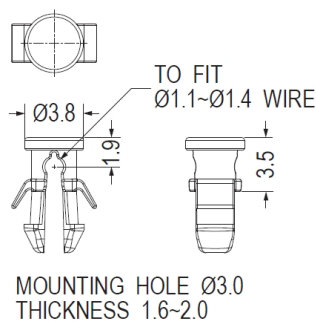
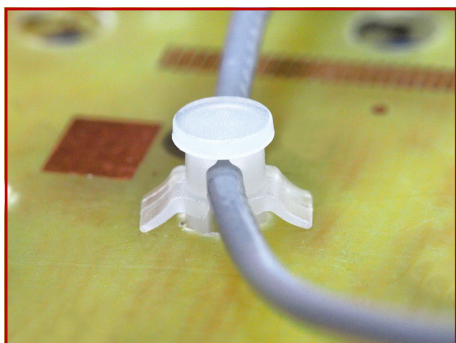

PART NO	PACKAGE
TX-3	1000

天线束线座 WIRE MOUNT 配线固定座



- ◆ MATERIAL : NYLON 66(UL)
- ◆ FLAME CLASS : 94V-2,94V-0
- ◆ COLOR : NATURAL/BLACK
- ◆ UNIT: mm

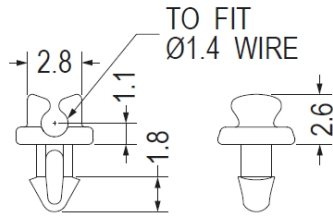

HOLE IN P.C.B Ø2.0
THICKNESS 1.6

PART NO	PACKAGE
CHB-13	2000

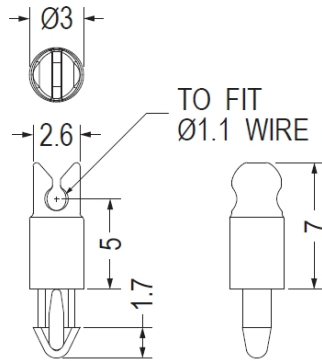

HOLE IN P.C.B Ø2.0
THICKNESS: T

用途：天线束线座,配线固定座,将电线固定于机壳上，电线不易磨损，配线整齐美观。

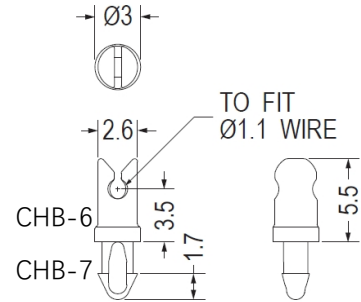

HOLE IN P.C.B Ø2.0
THICKNESS 1.6~2.0

PART NO	PACKAGE
CHB-14	2000

PART NO	T	PACKAGE
CHB-6	1.6~2.0	2000
CHB-7	1.0~1.2	2000
CHB-8	0.8	2000

天线束线座

电线固定夹片 WIRE CLAMP



- ◆ MATERIAL : STEEL
- ◆ MATERIAL: PVC TUBE(UL)
- ◆ COLOR : BLACK
- ◆ UNIT: mm

用途: 电线固定夹片, 使用于电子、计算机产品内部电线之固定, 可弯曲打开重复使用, 维修方便。

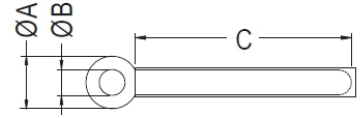

MATERIAL : STEEL
MATERIAL: POLYOLEFIN(UL)

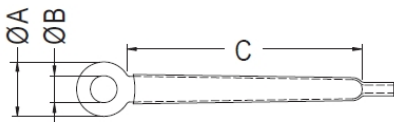

PART NO	A	B	C	PACKAGE
KWL-10	7.5	3.3	12.0	1000
KWL-11	7.5	3.3	32.0	1000
KWL-12	8.5	4.2	35.0	1000
KWL-13	5.6	3.5	29.9	1000
KWL-14	8.0	4.1	52.0	1000
KWL-15	7.5	3.2	52.0	1000
KWL-16	8.0	4.1	48.2	1000
KWL-17	8.0	3.6	62.0	1000
KWL-18	7.5	4.2	74.5	1000
KWL-19	8.4	5.1	60.0	500
KWL-20	8.0	4.1	78.5	500
KWL-21	10.0	6.0	78.0	500
KWL-22	7.5	4.2	94.5	500

PART NO	A	B	C	PACKAGE
KWL-1	7.5	3.3	32.0	1000
KWL-2	8.5	4.2	35.0	1000
KWL-3	8.0	4.1	52.0	1000
KWL-4	7.5	3.3	52.0	1000
KWL-5	8.0	3.6	62.0	1000
KWL-6	7.5	4.2	74.5	1000
KWL-7	8.4	5.1	60.0	500
KWL-8	8.0	4.1	78.5	500
KWL-9	10.0	6.0	78.0	500

电线固定夹片

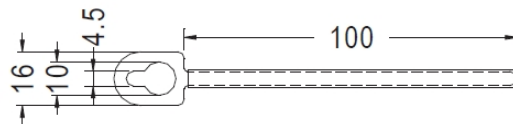
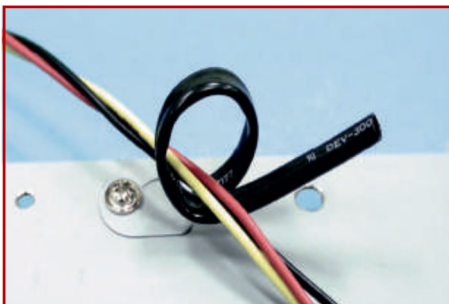

PART NO	PACKAGE
KWL-23	500

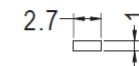
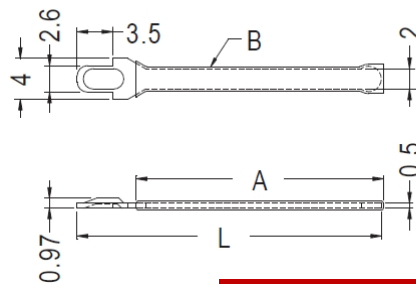

HOLE IN P.C.B

PART NO	A	B	L	PACKAGE
KWL-24	24.0	1.5 HEAT SHRINKING	30.0	1000
KWL-25	25.0	1.93 PVC TUBE	30.0	1000
KWL-26	47.0	1.5 HEAT SHRINKING	50.0	1000
KWL-27	45.0	1.93 PVC TUBE	50.0	1000

- ◆ MATERIAL : TIN PLATED STEEL
- ◆ MATERIAL: PVC TUBE(UL)/POLYOLEFIN(UL)
- ◆ COLOR : BLACK
- ◆ UNIT: mm

电线固定板 FLAT CABLE CLAMP 配线固定板

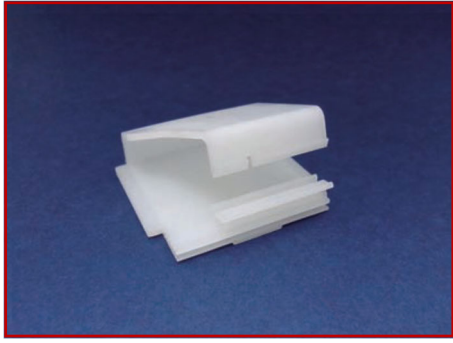

- ◆ MATERIAL : NYLON 66(UL)
- ◆ FLAME CLASS : 94V-2,94V-0
- ◆ COLOR : NATURAL/BLACK
- ◆ UNIT: mm

用途：电线固定板,用于电线之固定。

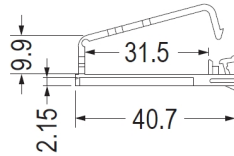
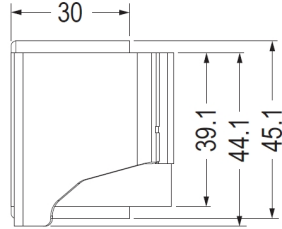

PART NO	PACKAGE
WS-T160	200

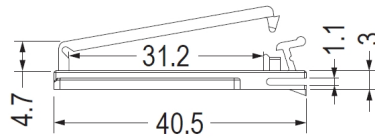
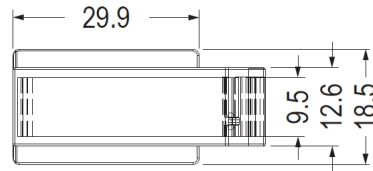

PART NO	PACKAGE
WS-T161	200

电线固定扣 CABLE CLAMP 压线板



- ◆ MATERIAL : NYLON 66(UL)
- ◆ FLAME CLASS : 94V-2/94V-0
- ◆ COLOR : NATUAL/BLACK/BLUE
- ◆ UNIT: mm

用途：电线固定扣，固定电线于机器中，整齐美观。

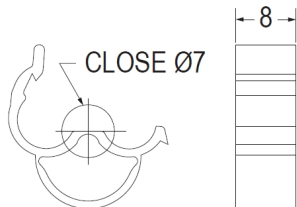

PART NO	PACKAGE
WS-T262	1000

电线固定座 WIRE CLIP 自粘式配线固定座 背胶式



- ◆ MATERIAL : NYLON 66(UL)
- ◆ FLAME CLASS : 94V-2
- ◆ COLOR : NATUAL
- ◆ UNIT: mm

用途：电线固定座,配线固定座,固定电线于PC板或机板上，维修方便，不占空间。

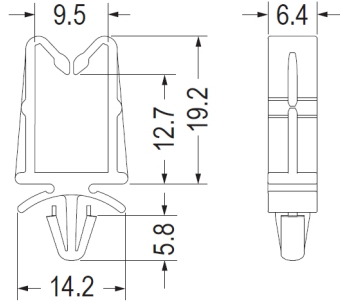

CHASSIS \varnothing 4.7~ \varnothing 4.9
THICKNESS 0.8~2.0

PART NO	PACKAGE
WS-T750	1000



- ◆ MATERIAL : NYLON 66(UL)
- ◆ FLAME CLASS : 94V-2/94V-0
- ◆ COLOR : NATUAL/BLACK
- ◆ UNIT: mm

用途：电线固定座,配线固定座,固定电线于PC板或机板上，维修方便，不占空间。

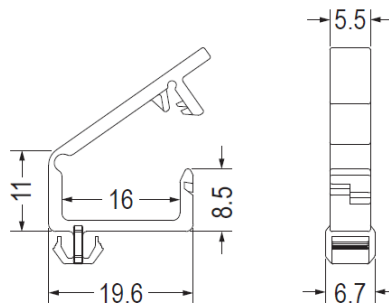

MOUNTING HOLE
THICKNESS 1.6

PART NO	PACKAGE
WS-T913	1000

电线固定座 WIRE CLIP 自粘式配线固定座 背胶式



- ◆ MATERIAL : NYLON 66(UL)
- ◆ FLAME CLASS : 94V-2/94V-0
- ◆ COLOR : NATUAL/BLACK
- ◆ UNIT: mm

用途：电线固定座，固定电线于PC板或机板上，维修方便，不占空间。

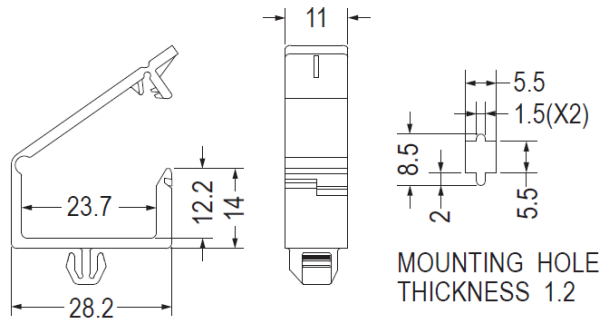

PART NO	PACKAGE
WS-T914	1000

电线固定扣

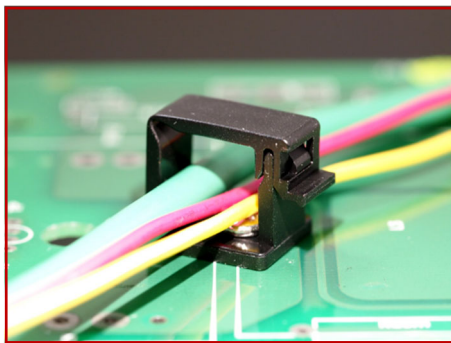

- ◆ MATERIAL : NYLON 66(UL)
- ◆ FLAME CLASS : 94V-2/94V-0
- ◆ COLOR : NATUAL/BLACK
- ◆ UNIT: mm

用途：电线固定座，可用背胶或螺丝固定，可快速捆扎及解开电线。

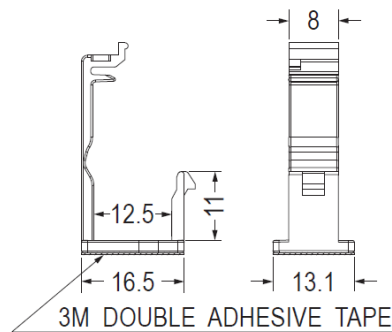

PART NO	PACKAGE
WS-T915	500

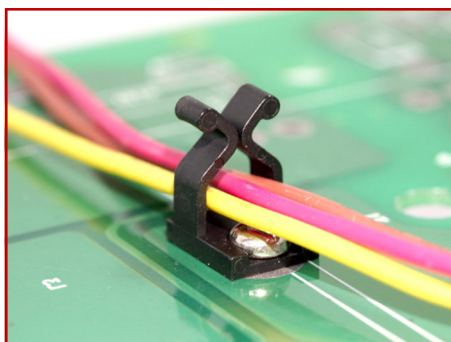

- ◆ MATERIAL : NYLON 66(UL)
- ◆ FLAME CLASS : 94V-2/94V-0
- ◆ COLOR : NATUAL/BLACK
- ◆ UNIT: mm

用途：电线固定座，使用螺丝固定，可快速拆卸电线，维修方便，不占空间。

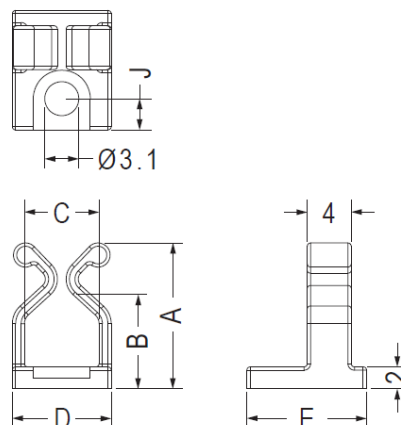

PART NO	A	B	C	D	E	J	PACKAGE
WS-T916	17.5	9.1	9.0	12.7	12.7	3.5	1000
WS-T917	13.3	6.6	6.8	9.0	10.9	2.85	1000

07

电线固定座 WIRE CLIP 自粘式配线固定座 背胶式

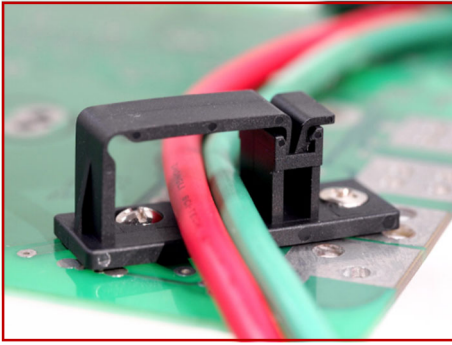

- ◆ MATERIAL : NYLON 66(UL)
- ◆ FLAME CLASS : 94V-2/94V-0
- ◆ COLOR : NATUAL/BLACK
- ◆ UNIT: mm

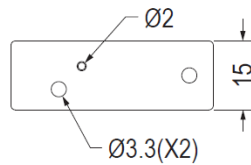
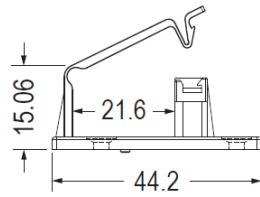

用途：电线固定座,用于电子、计算机内部电线固定，装配容易，美观不脱落。

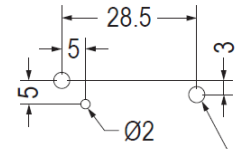

FOR M3 SCREWS(X2)

MOUNTING HOLE

PART NO	PACKAGE
WS-T918	250



- ◆ MATERIAL : NYLON 66(UL)
- ◆ FLAME CLASS : 94V-2
- ◆ COLOR : NATUAL
- ◆ UNIT: mm

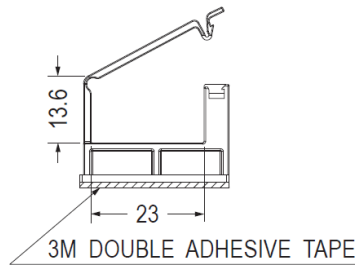
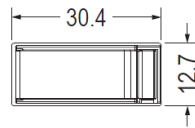

用途：电线固定座,背胶式，用于电子、计算机内部电线固定，装配容易，美观不脱落。

PART NO	PACKAGE
WS-T919	1000

电子电脑塑胶五金零件目录

1.LED间隔柱

2.LED导光柱 LED导光盖 LED遮光罩

3.LED座 LED座套 红外线灯罩 光纤座

4.90°LED灯座 45°LED灯座

5. PC板间隔柱 PC板隔离柱

6. 塑料铜柱 尼龙柱 六角隔离柱 塑胶铜柱 铜柱 导光板隔离柱 圆体间隔柱 PC板固定定座 固定扣 电路板隔离柱 导电隔离柱

7. 排线固定座 自粘式配线固定座 排线固定夹 压线板 电线固定座 扭线固定座 扭式固定环 扎线固定座 电源线固定座 电源线固定座插头固定扣 天线固定座 T8灯管固定座 风扇束线座 光纤固定座

8. PC板端子 接线插片端子 PC板焊接端子 接地片 圆形连接片 弹片 测试针 探针 测试点 保险丝座 保险丝盖 插式电线连接头 闭端端子 弹簧螺纹端子 压线帽 端子台 快速接线夹 跳线

9. 仪表脚垫 插销式脚垫 螺丝固定脚垫 脚垫 抗震脚垫 磁铁脚垫 橡胶脚垫 自粘脚垫 银框脚垫 金框脚垫 橡胶垫圈 橡胶华司 橡胶垫片 硅胶脚垫

10. 塑料螺丝 塑胶螺丝 翼型塑料螺丝 塑料螺帽 塑料螺帽 蝶形螺母 止付螺丝 紧定螺钉 内牙螺丝 螺丝帽盖 手转螺丝 手拧螺丝 滚花螺丝 手转螺母 手拧螺母

11. PC板拉柄 PC板耳把 PC板导槽 电路板导轨 PCB导轨槽 直立式导槽 电路板导轨

12. 晶体管盖 电晶体盖 晶体管垫片 电晶体垫片 晶体管座 电晶体座 T-O3晶体管座 石英晶体垫片 垫圈 华司 垫片 TO-220晶体管座 光电晶体座 电晶体座 IR晶体座 霍尔晶体座 硅胶帽套 功率晶体导热硅片 功率晶体压板 电源固定压条 晶体管固定弹片 五金弹片 电晶体固定弹片 晶体管夹

电子电脑塑胶五金零件目录

13.电容器垫片 垫圈 华司 电容器座 电容器帽套 电容器固定座 电容器盖 电容器护套 压敏护套 硅胶帽套

14.热敏电阻座 电阻保护座 保护电阻器 可变电阻盖

15.陶瓷零件垫片 零件垫片 垫圈 华司 零件垫座 IC座 桥式整流座 跳线座 线圈座 滤波器垫片 绝缘柱 螺丝垫片 滚轮 PC板垫片 球击缓冲垫片 尼龙垫圈 尼龙弹簧垫片 散热陶瓷垫片

16.功率IC盖 桥式整流盖 保护盖 开关盖 硅胶盖 绝缘盖 电池盖 末端套管 软质端子保护套PC端子保护套 喇叭座 拉柄箱扣 线圈固定座 DRAM固定带 十字型插件式固定器 轨道固定器

17.孔塞 扣式孔塞 扣式塞头 DVI防尘盖 螺丝孔孔塞 螺丝塞头 螺纹孔塞

18.电源线扣 电线固定夹 护线环 橡胶圈 护线圈 开口式护线环 橡胶线环 硅胶线环 硅胶护线环 天线护线环 方型护线环 U型护线环 抗震护线环 防震线环 抗震线环用插销 抗震线环用螺丝 硬盘驱动器防震座 透气压力平衡固定头 透气平衡压力固定扣

19.把手 机箱把手 仪器门拉手 纸箱把手 纸箱配件 打包扣 外箱护脚垫 纸箱外箱扣

20.阻尼齿轮 阻尼器 缓冲齿轮

21.电线扎带 电线束线带 固定带 扎线 电源线收线带 珠型扎带 水管座 扎带座 扎带扣 吊勾粘扣带 绑线带

22.USB座护盖 USB端口保护盖 USB端口防尘盖 MICRO USB防尘盖 MINI USB座护盖USB Type-C防尘盖 USB防尘盖 RJ-45防尘盖 RJ-11防尘盖 RJ-12防尘盖 RJ-22防尘盖 电源插头防尘盖 电源插头保护座 电源插头防尘座 电源插头防尘盖 光纤连接器护盖 光纤连接器护套 光纤防尘盖 PC板金手指防尘盖 HDMI防尘盖 Mini数位端子防尘盖 汽车点烟器防尘盖BBU防尘盖 DVI防尘盖 连接器盖 SIM Card Cap防尘盖 SD防尘盖 KVM防尘盖 CF防尘盖 防尘盖 端子盖 S端子盖 平衡端子盖 BNC绝缘座 SATA防尘盖 ESATA护盖 DP端子防尘盖 Mini D.P数位端子防尘盖 D.Type防尘盖 VGA防尘盖 IDE Connector防尘盖 PC端子防尘盖 端子防尘盖 1394端子防尘盖 零件盖 电源盖 机板电源保护盖 连接器座 PCMIC卡保护盖 面板 DDR防尘盖 D-Sub保护盖 高压防尘盖 SD保护盖 Micoro SD卡保护盖 SIM卡保护盖 防水帽盖 帽盖连接带 防水圈 电脑风扇防护盖 电脑风扇防尘座 电脑风扇框护垫 电脑风扇支架 开关遮板 光纤晶体座

电子电脑塑胶五金零件目录

23.插销 铆钉 尼龙铆钉 螺丝铆钉 散热片铆钉 塑料铆钉 电脑风扇铆钉 散热片扣件 弹簧铆钉 螺丝固定座 膨胀螺栓 墙塞 无帽鱼型膨胀管 墙面固定座 石膏板固定座

24.固定扣 门扣开关 机器门扣开关 弹簧固定座 旋转型门扣 门扣碰珠 磁铁门扣

55.工具 线扣工具 进口束线枪 旗型端子工具 国产束线枪 非绝缘端子工具 绝缘端子工具



电子电脑塑胶五金零件目录



1.LED间隔柱



2.LED导光柱



3.LED座



4.90°LED灯座



5.PC板间隔柱



6.塑料铜柱



7.排线固定座



8.PC板端子



9.仪表脚垫



10.塑料螺丝



11.PC板拉柄导槽



12.晶体管盖

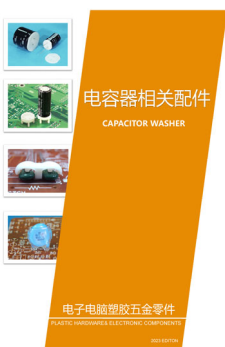

13.电容器垫片



14.热敏电阻座



15.陶瓷零件垫片



16.功率IC盖



电子电脑塑胶五金零件目录



17.孔塞



18.电源线扣



19.机箱把手



20.阻尼齿轮



21.电线扎带



22.USB座护盖



23.尼龙铆钉



24.门扣开关



55.工具

电子电脑塑胶五金零件

PLASTIC HARDWARE & ELECTRONIC COMPONENTS



南京诺金电气有限公司

Nanjing Nojinqing Electric Co., Ltd.

2023.03/17/18

选型手册总目录

本公司保留因质量改进、后续开发或生产要求引起的设计更改权力。本产品目录为元件的详细说明，不能做担保依据。使用者有义务审核该元件是否符合应用范围的规定。



微信



QQ

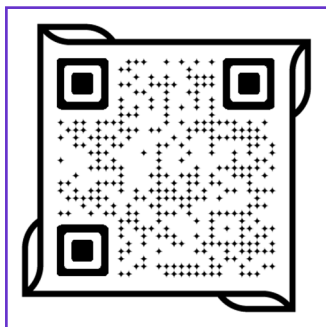

网站

南京诺金电气有限公司

Nanjing Nowking Electric Co., Ltd

- ◆ Tel: 025-85422485 85436028 85437901
- ◆ Wechat/Mobile :13770725488
- ◆ QQ:260678075
- ◆ E-mail: nk@nowking.com
- ◆ Http://www.nowking.com
- ◆ Http://www.kyphe.com