

# 电容器相关配件

CAPACITOR WASHER

电子电脑塑胶五金零件

PLASTIC HARDWARE & ELECTRONIC COMPONENTS

2023 EDITON

电容器垫片 垫圈 华司 电容器座 电容器帽套 电容器固定座 电容器盖 电容器护套 压敏护套 硅胶帽套

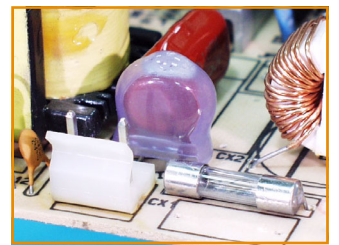
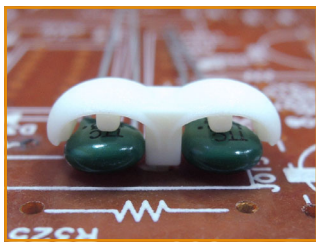
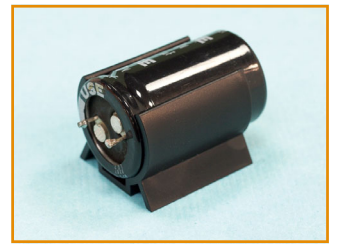
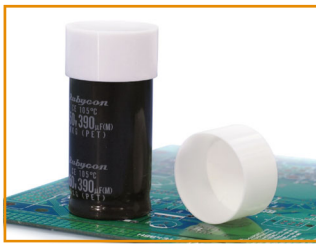
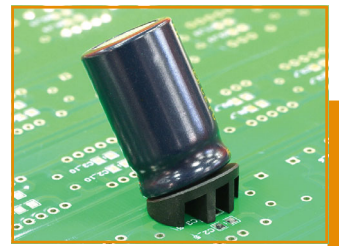
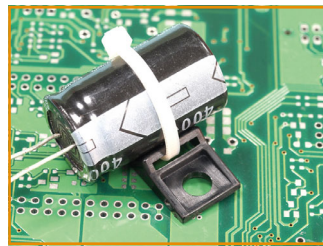
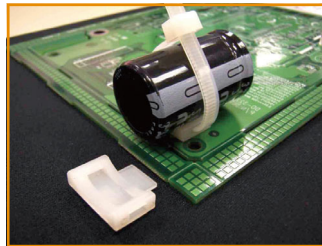
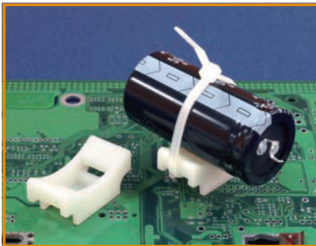
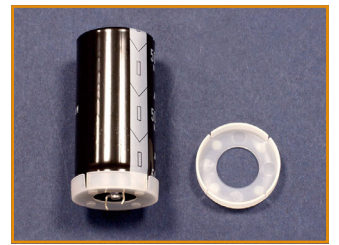
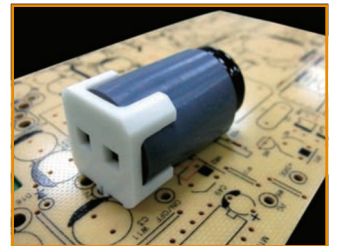
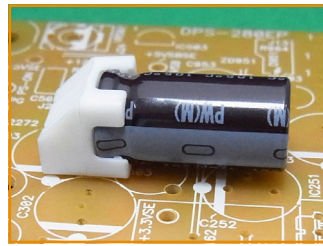
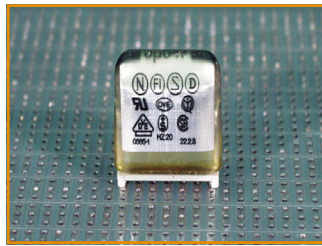
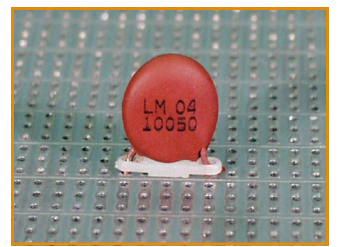
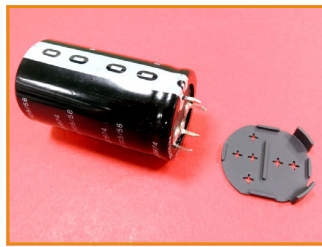
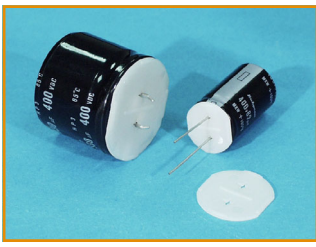

电容器垫片

电容器垫片 垫圈 华司 电容器座 电容器帽套 电容器固定座 电容器盖 电容器护套 压敏护套 硅胶帽套

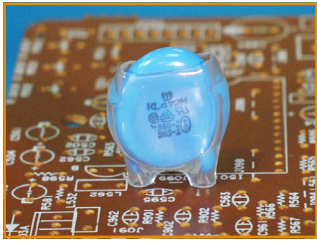



# 电容器垫片 CAPACITOR WASHER 垫圈 华司

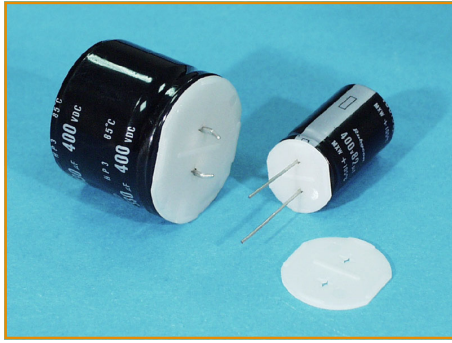

- ◆ MATERIAL : NYLON 66 (UL)
- ◆ FLAME CLASS : 94V-0/94V-2
- ◆ COLOR : NATURAL/BLACK
- ◆ UNIT: mm

用途： 电容器垫片，用于大电容器之垫座。

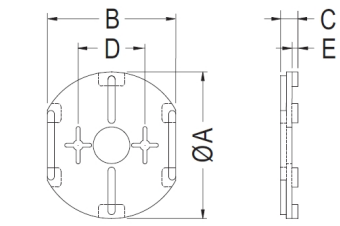
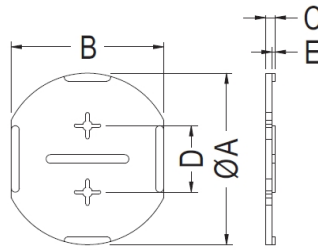

CITO-01

PART NO	A	B	C	D	E	PACKAGE
CITO-01	22.8	19.8	2.7	10.4	0.9	500
CITO-02	10.5	-	1.0	5.0	-	1000
CITO-03	16.2	14.6	1.5	7.5	0.5	1000
CITO-04	18.2	16.4	1.5	7.5	0.5	1000
CITO-05	22.2	20.0	1.5	10.0	0.5	500
CITO-06	25.7	23.0	1.5	10.0	0.5	500
CITO-07	25.7	23.0	0.8	10.0	-	500
CITO-08	30.3	27.2	1.5	10.0	0.5	500
CITO-09	35.3	31.8	1.5	10.0	0.5	500
CITO-10	35.3	31.8	2.0	10.0	1.0	500
CITO-11	12.0	-	1.2	5.5	-	1000

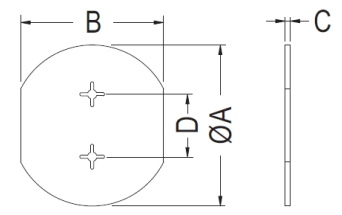

CITO-07

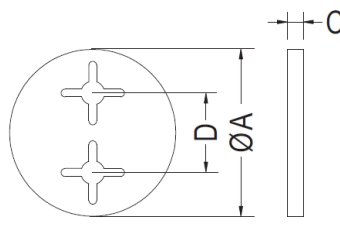

CITO-02

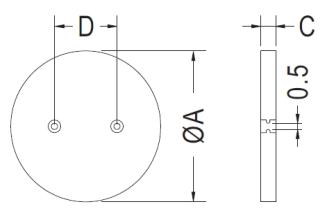

CITO-11

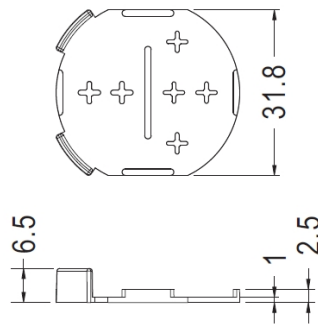
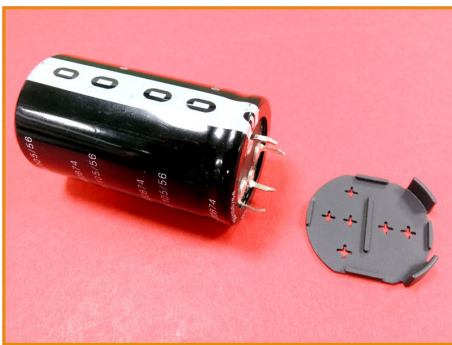

PART NO	PACKAGE
CITO-20	1000

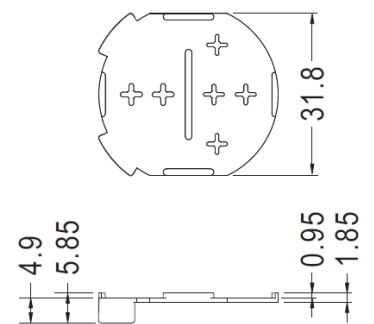

PART NO	PACKAGE
CITO-21	1000

电容器垫片



# 电容器垫片 CAPACITOR WASHER 垫圈 华司

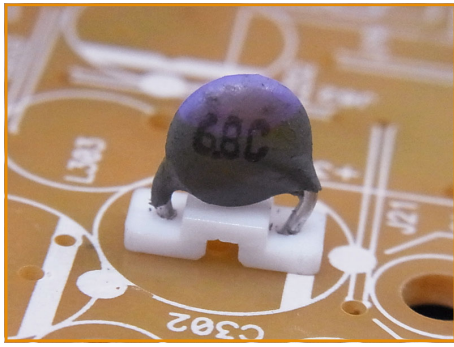

- ◆ MATERIAL : NYLON 66 (UL)
- ◆ FLAME CLASS : 94V-0/94V-2
- ◆ COLOR : NATURAL/BLACK
- ◆ UNIT: mm

用途： 电容器垫片，用于电容器接脚保护。

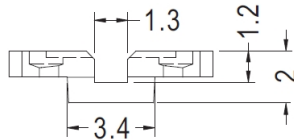
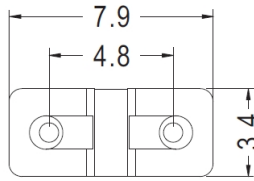

PART NO	PACKAGE
CITO-14	2000

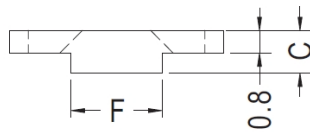
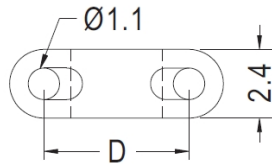
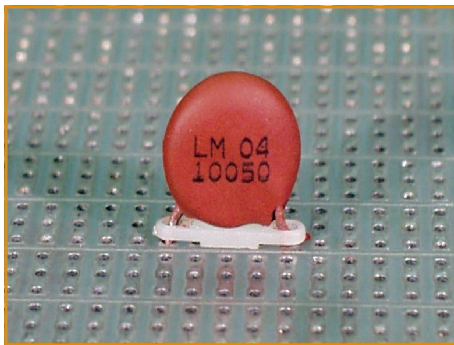

PART NO	C	D	F	PACKAGE
CITO-15	1.5	5.08	3.2	2000
CITO-16	1.2	7.6	4.0	2000
CITO-17	1.2	10.1	5.0	2000

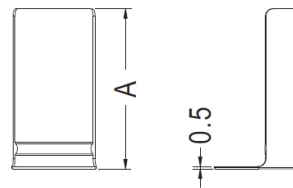
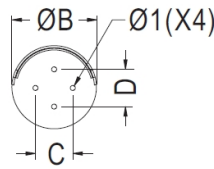

PART NO	A	B	D	E	PACKAGE
CITO-18	24.5	11.2	5.0	5.0	1000
CITO-19	31.8	16.5	7.4	7.7	1000

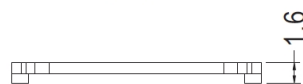
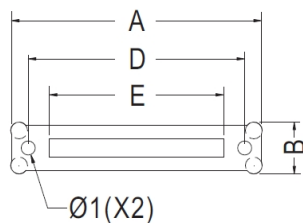
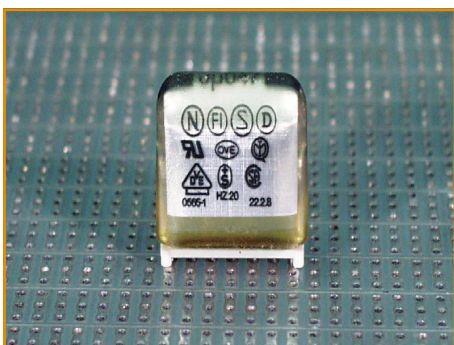

PART NO	A	B	D	E	PACKAGE
CITO-12	17.8	3.7	15.5	12.7	1000
CITO-13	25.0	7.0	22.5	17.0	1000

# 电容器座 CAPACITOR HOUSING

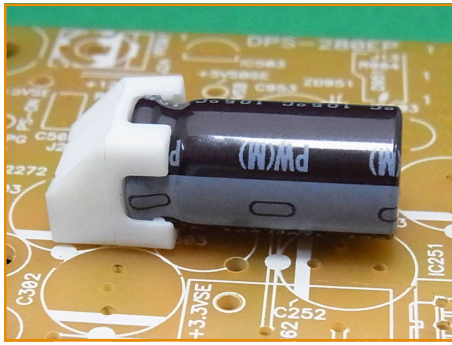

- ◆ MATERIAL : NYLON 66 (UL)
- ◆ FLAME CLASS : 94V-0/94V-2
- ◆ COLOR : NATURAL/BLACK
- ◆ UNIT: mm

用途：电容器座，用于电容器接脚保护。

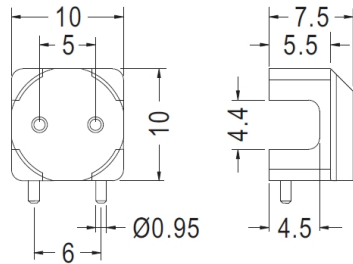

PART NO	PACKAGE
CAPHL-1	1000

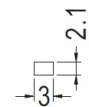
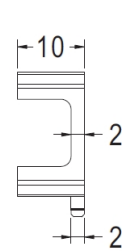
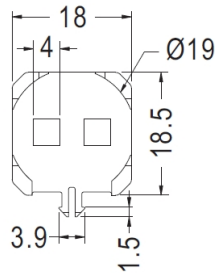
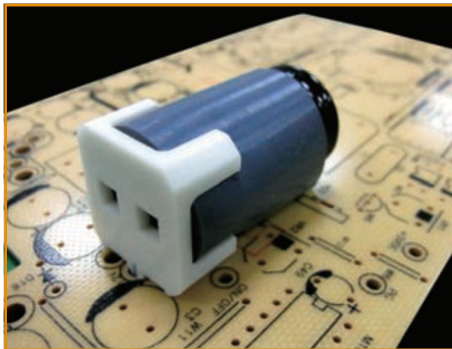

MOUNTING HOLE THICKNESS 1.6

PART NO	PACKAGE
CAPHL-2	500

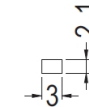
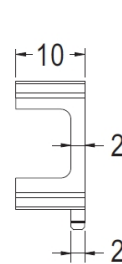
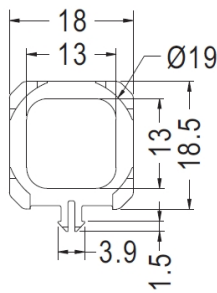

MOUNTING HOLE THICKNESS 1.6

PART NO	PACKAGE
CAPHL-3	1000

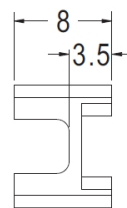
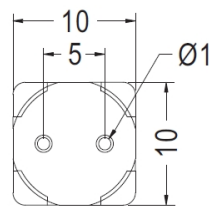

適用於 Ø10 的電容

PART NO	PACKAGE
CAPHL-4	1000

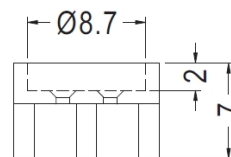
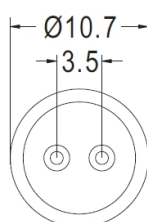

PART NO	PACKAGE
CAPHL-15	1000

# 电容器座 CAPACITOR HOUSING

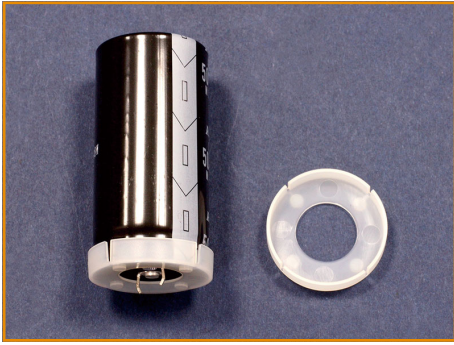

- ◆ MATERIAL : NYLON 66 (UL)
- ◆ FLAME CLASS : 94V-0/94V-2
- ◆ COLOR : NATURAL/BLACK
- ◆ UNIT: mm

用途：电容器座，用于电容器接脚保护。

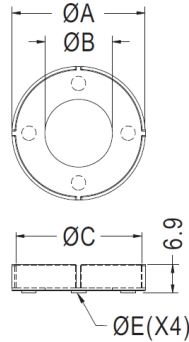

PART NO	A	B	D	E	PACKAGE
CAPHL-5	20.3	8.9	18.6	2.7	1000
CAPHL-17	27.3	13.9	25.6	3.5	500
CAPHL-18	32.3	16.4	30.5	3.5	500
CAPHL-19	18.3	8.9	16.6	2.7	1000
CAPHL-20	12.3	6.4	10.6	2.5	1000

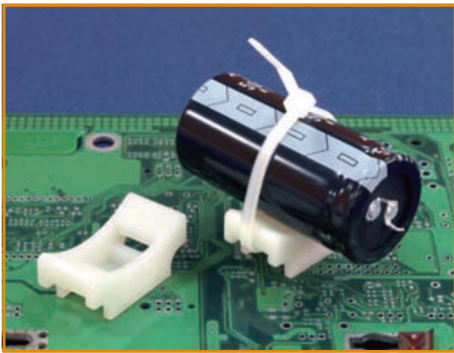

- ◆ MATERIAL : NYLON 66 (UL)
- ◆ FLAME CLASS : 94V-0/94V-2
- ◆ COLOR : NATURAL/BLACK
- ◆ UNIT: mm

用途：电容器座，用于电容器接脚保护，配合束线带固定使用。

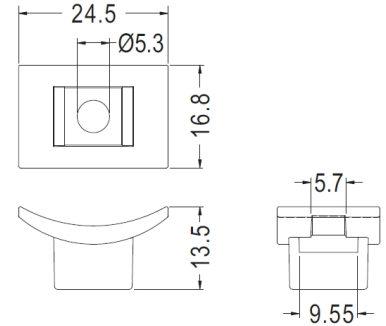
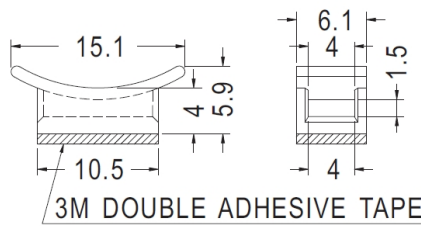

PART NO	PACKAGE
CAPHL-6	1000

PART NO	PACKAGE
CAPHL-14	1000

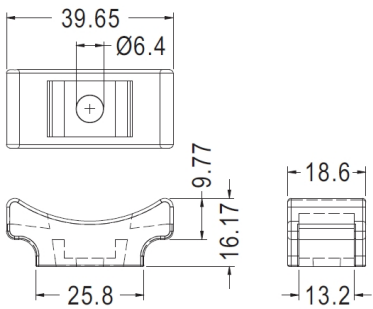

PART NO	PACKAGE
CAPHL-16	1000

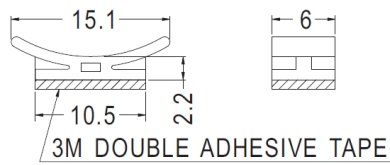

PART NO	PACKAGE
CAPHL-8	1000

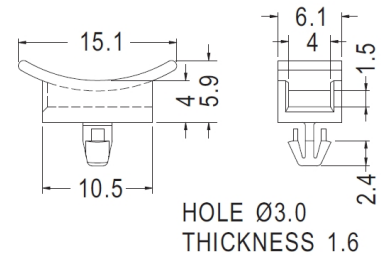

PART NO	PACKAGE
CAPHL-7	1000

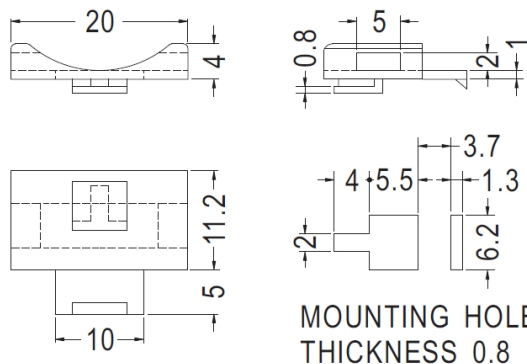
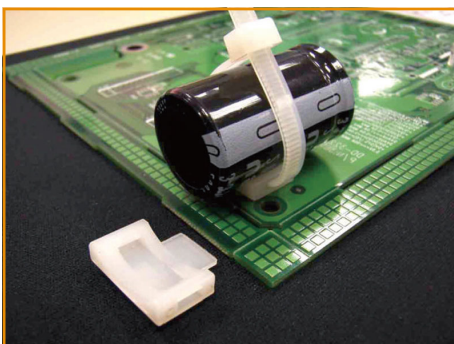

PART NO	PACKAGE
CAPHL-9	500



# 电容器座 CAPACITOR HOUSING

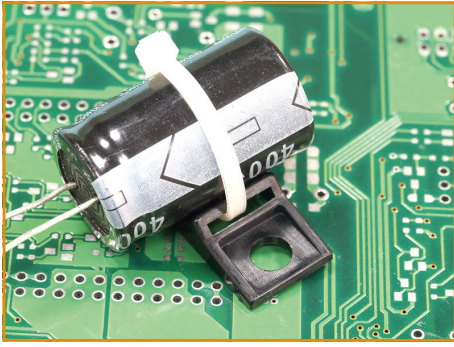

- ◆ MATERIAL : NYLON 66 (UL)
- ◆ FLAME CLASS : 94V-0/94V-2
- ◆ COLOR : NATURAL/BLACK
- ◆ UNIT: mm

用途： 电容器座，配合束线固定用。

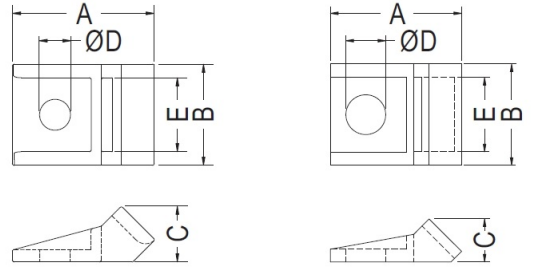

PART NO	A	B	C	D	E	SCREW SIZE	PACKAGE
CAPHL-10	17.4	13.5	5.7	5.3	10.1	#10	1000
CAPHL-11	27.4	21.4	10.3	8.4	16.7	5/16	500
CAPHL-21	23.0	16.4	9.04	5.2	12.0	M5	500
CAPHL-24	19.0	11.3	8.0	4.2	8.3	M4	1000

CAPHL-21  
CAPHL-24

Mounting Screw Size

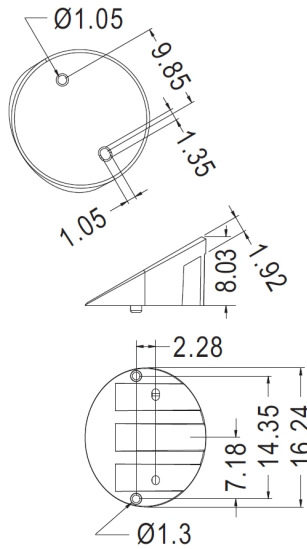
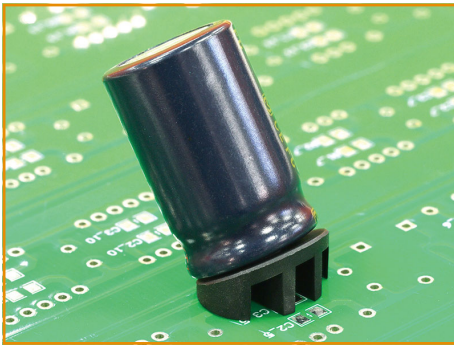

用途： 电容器座，用于电容器接脚保护。

PART NO	PACKAGE
CAPHL-12	1000

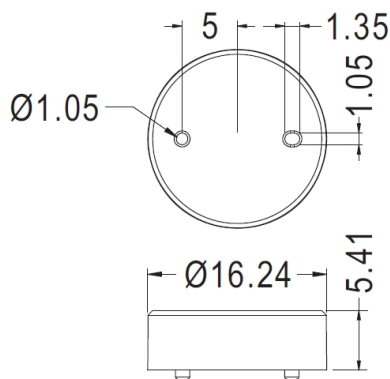

PART NO	PACKAGE
CAPHL-13	1000

## 电容器座 CAPACITOR HOUSING

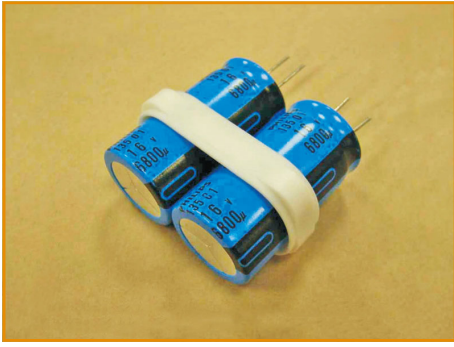

- ◆ MATERIAL : NYLON 66 (UL)
- ◆ FLAME CLASS : 94V-0/94V-2
- ◆ COLOR : NATURAL/BLACK
- ◆ UNIT: mm

用途： 电容器座，配合电容器固定用。

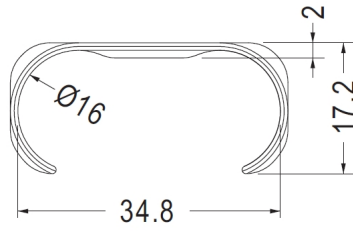

PART NO	PACKAGE
CAPHL-22	100

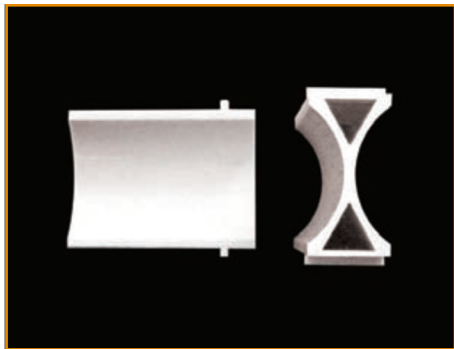

- ◆ MATERIAL : ABS (UL)
- ◆ FLAME CLASS : 94HB
- ◆ COLOR : GRAY
- ◆ UNIT: mm

用途： 电容器座，用于电容器固定。

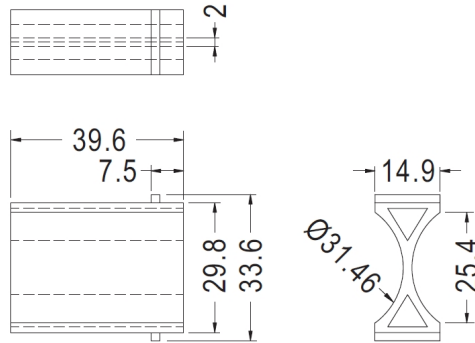

PART NO	PACKAGE
CAPHL-23	250

# 电容器帽套 CAPACITOR COVER

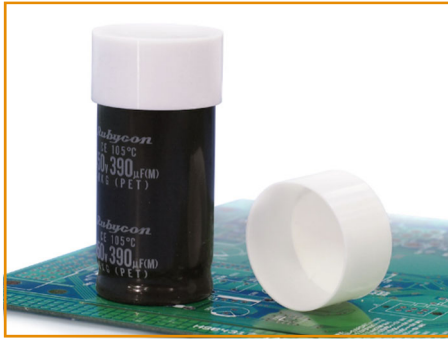

- ◆ MATERIAL : NYLON 66 (UL)
- ◆ FLAME CLASS : 94V-0/94V-2
- ◆ COLOR : NATURAL/BLACK
- ◆ UNIT: mm

用途： 电容器帽套，配合束线固定用。  
用于大电容器之绝缘与保护。

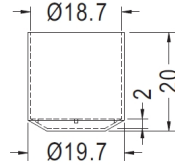
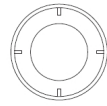
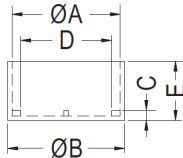
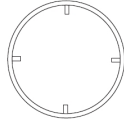
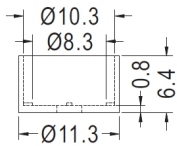
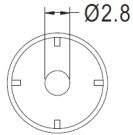

PART NO	A	B	C	D	E	PACKAGE
BCCT-01	16.7	18.2	1.75	13.7	10.2	500
BCCT-02	18.7	20.2	1.75	15.7	10.2	500
BCCT-03	22.0	23.4	1.05	18.0	8.0	2000
BCCT-04	26.0	27.2	0.75	22.0	8.0	2000
BCCT-05	16.5	17.5	1.5	12.4	20.0	500
BCCT-06	27.0	28.2	1.05	23.0	15.0	2000
BCCT-07	13.2	14.2	2.5	10.2	15.0	500
BCCT-08	10.3	11.3	0.8	8.3	6.4	500

PART NO	PACKAGE
BCCT-09	500

PART NO	PACKAGE
BCCT-10	500

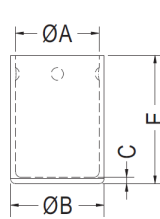
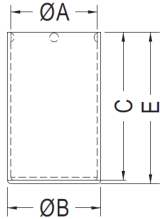
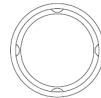
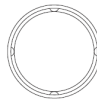
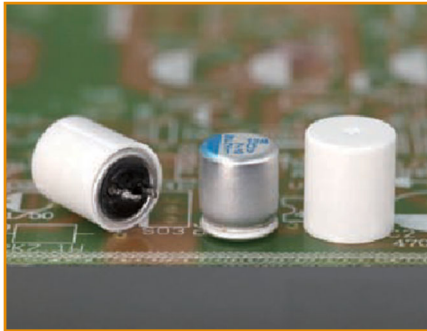

PART NO	A	B	C	E	PACKAGE
BCCT-12	6.5	7.3	0.5	10.0	1000
BCCT-13	6.5	7.3	0.4	12.0	1000
BCCT-14	8.2	9.0	0.5	10.0	1000
BCCT-15	8.2	9.0	0.4	13.4	1000
BCCT-16	10.3	11.1	0.4	18.0	1000

电容器帽套



- ◆ MATERIAL : SILICON RUBBER (UL)
- ◆ FLAME CLASS : 94V-0
- ◆ COLOR : BLACK
- ◆ UNIT: mm

用途： 电容器座，用于大电容器之绝缘与保护。

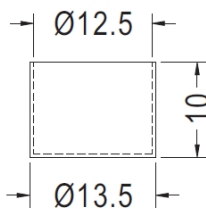
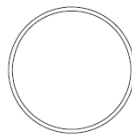

PART NO	PACKAGE
BCCT-11	500



# 电容器固定座 CAPACITOR MOUNT



- ◆ MATERIAL : NYLON 66 (UL)
- ◆ FLAME CLASS : 94V-0/94V-2
- ◆ COLOR : NATURAL/BLACK
- ◆ UNIT: mm

用途： 电容器固定座，固定电容器于机板上，维修方便，不占空间。

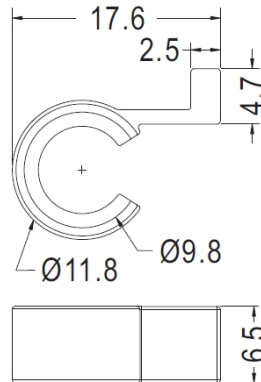

PART NO	PACKAGE
CW-K1	1000

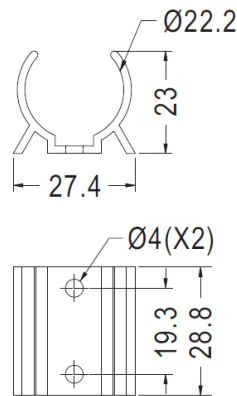

WALL THICKNESS 1.7

PART NO	PACKAGE
CW-K2	500

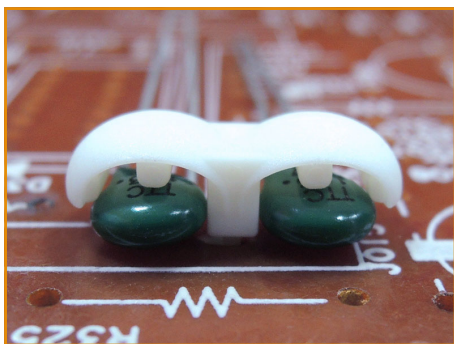

- ◆ MATERIAL : NYLON 66 (UL)
- ◆ FLAME CLASS : 94V-0/94V-2
- ◆ COLOR : NATURAL/BLACK
- ◆ UNIT: mm

用途： 电容器座，配合电容器固定用。

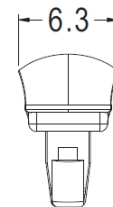
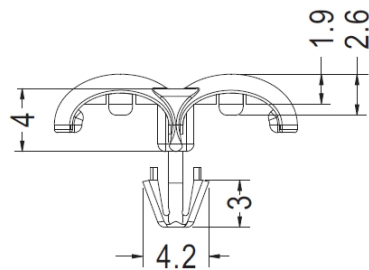

MOUNTING HOLE Ø3.0  
CHASSIS THICKNESS 1.5

PART NO	PACKAGE
CW-K3	1000

# 电容器盖 CAPACITOR COVER

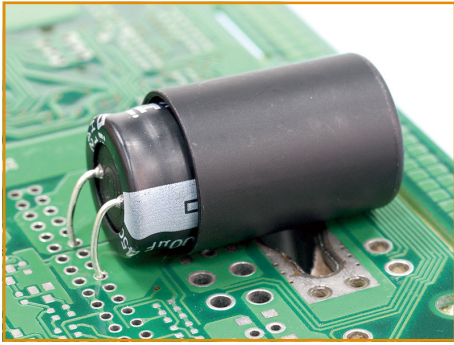

- ◆ MATERIAL : NYLON 66 (UL)
- ◆ FLAME CLASS : 94V-0/94V-2
- ◆ COLOR : NATURAL/BLACK
- ◆ UNIT: mm

用途： 电容器盖，用于电容器之绝缘与保护。

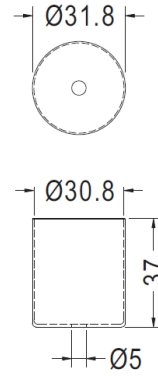
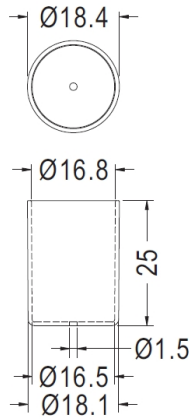

PART NO	PACKAGE
DRG-1	500

PART NO	PACKAGE
DRG-2	100

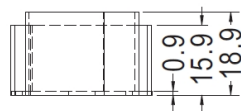
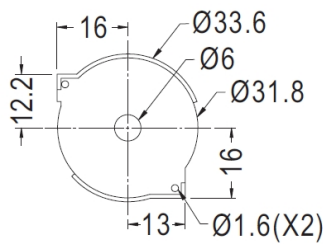

PART NO	PACKAGE
GFR-7	1000

# 电容器护套 CAPACITOR COVER 压敏护套

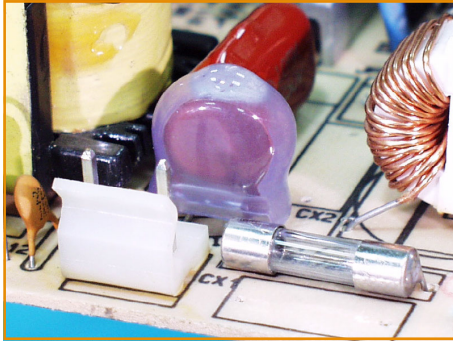

- ◆ MATERIAL : SOFT P.V.C
- ◆ COLOR : NATURAL
- ◆ UNIT: mm

用途： 电容器护套，用于电容器之绝缘与防尘。

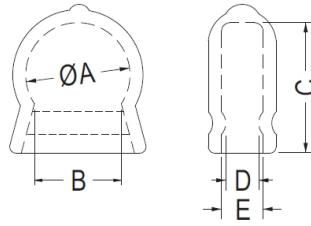

- 如需UL認可材質，請在料號尾碼加UL下單
- Please add UL after Part Number for UL certified material.

PART NO	A	B	C	D	E	PACKAGE
HUL-1	10.5	9.0	12.3	3.0	4.0	1000
HUL-4	8.5	7.5	10.0	3.0	3.0	1000
HUL-5	12.0	10.0	15.0	3.8	4.8	1000

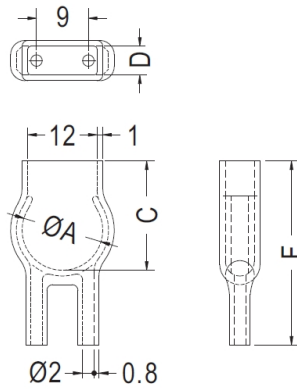
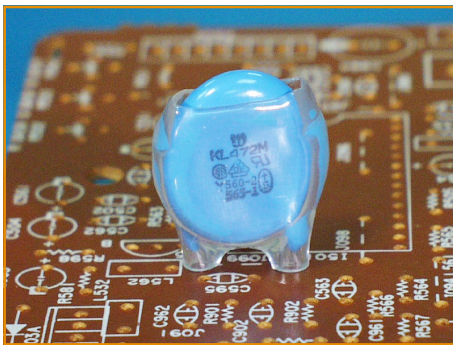

- 如需UL認可材質，請在料號尾碼加UL下單
- Please add UL after Part Number for UL certified material.

PART NO	A	C	D	F	PACKAGE
HUL-2	14.0	16.0	4.0	22.0	1000
HUL-3	16.0	19.0	5.0	32.0	1000



硅胶帽套 SILICON INSULATOR COVER 矽胶帽套

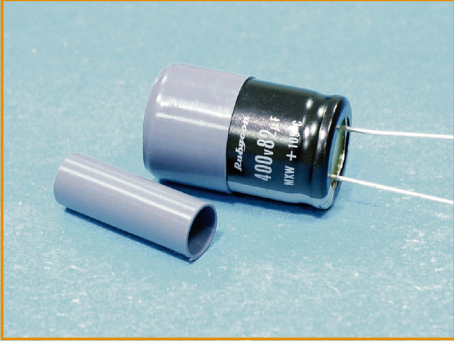

- ◆ MATERIAL : SILICON (UL)
- ◆ FLAME CLASS : 94V-0/94HB
- ◆ COLOR : GRAY
- ◆ UNIT: mm

用途：硅胶帽套，用于大电解电容之外壳绝缘，绝缘性特佳。

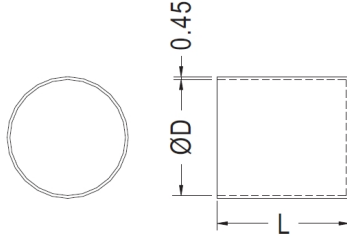

PART NO	D	L	PACKAGE
RUCT-1	7.8	26.0	500
RUCT-2	16.7	15.0	500
RUCT-3	18.5	25.0	500
RUCT-19	13.0	15.0	500

# 电子电脑塑胶五金零件目录

1.LED间隔柱

2.LED导光柱 LED导光盖 LED遮光罩

3.LED座 LED座套 红外线灯罩 光纤座

4.90°LED灯座 45°LED灯座

5. PC板间隔柱 PC板隔离柱

6. 塑料铜柱 尼龙柱 六角隔离柱 塑胶铜柱 铜柱 导光板隔离柱 圆体间隔柱 PC板固定定座 固定扣 电路板隔离柱 导电隔离柱

7. 排线固定座 自粘式配线固定座 排线固定夹 压线板 电线固定座 扭线固定座 扭式固定环 扎线固定座 电源线固定座 电源线固定座插头固定扣 天线固定座 T8灯管固定座 风扇束线座 光纤固定座

8. PC板端子 接线插片端子 PC板焊接端子 接地片 圆形连接片 弹片 测试针 探针 测试点 保险丝座 保险丝盖 插式电线连接头 闭端端子 弹簧螺纹端子 压线帽 端子台 快速接线夹 跳线

9. 仪表脚垫 插销式脚垫 螺丝固定脚垫 脚垫 抗震脚垫 磁铁脚垫 橡胶脚垫 自粘脚垫 银框脚垫 金框脚垫 橡胶垫圈 橡胶华司 橡胶垫片 硅胶脚垫

10. 塑料螺丝 塑胶螺丝 翼型塑料螺丝 塑料螺帽 塑料螺帽 蝶形螺母 止付螺丝 紧定螺钉 内牙螺丝 螺丝帽盖 手转螺丝 手拧螺丝 滚花螺丝 手转螺母 手拧螺母

11. PC板拉柄 PC板耳把 PC板导槽 电路板导轨 PCB导轨槽 直立式导槽 电路板导轨

12. 晶体管盖 电晶体盖 晶体管垫片 电晶体垫片 晶体管座 电晶体座 T-O3晶体管座 石英晶体垫片 垫圈 华司 垫片 TO-220晶体管座 光电晶体座 电晶体座 IR晶体座 霍尔晶体座 硅胶帽套 功率晶体导热硅片 功率晶体压板 电源固定压条 晶体管固定弹片 五金弹片 电晶体固定弹片 晶体管夹

# 电子电脑塑胶五金零件目录

13.电容器垫片 垫圈 华司 电容器座 电容器帽套 电容器固定座 电容器盖 电容器护套 压敏护套 硅胶帽套

14.热敏电阻座 电阻保护座 保护电阻器 可变电阻盖

15.陶瓷零件垫片 零件垫片 垫圈 华司 零件垫座 IC座 桥式整流座 跳线座 线圈座 滤波器垫片 绝缘柱 螺丝垫片 滚轮 PC板垫片 球击缓冲垫片 尼龙垫圈 尼龙弹簧垫片 散热陶瓷垫片

16.功率IC盖 桥式整流盖 保护盖 开关盖 硅胶盖 绝缘盖 电池盖 末端套管 软质端子保护套PC端子保护套 喇叭座 拉柄箱扣 线圈固定座 DRAM固定带 十字型插件式固定器 轨道固定器

17.孔塞 扣式孔塞 扣式塞头 DVI防尘盖 螺丝孔孔塞 螺丝塞头 螺纹孔塞

18.电源线扣 电线固定夹 护线环 橡胶圈 护线圈 开口式护线环 橡胶线环 硅胶线环 硅胶护线环 天线护线环 方型护线环 U型护线环 抗震护线环 防震线环 抗震线环用插销 抗震线环用螺丝 硬盘驱动器防震座 透气压力平衡固定头 透气平衡压力固定扣

19.把手 机箱把手 仪器门拉手 纸箱把手 纸箱配件 打包扣 外箱护脚垫 纸箱外箱扣

20.阻尼齿轮 阻尼器 缓冲齿轮

21.电线扎带 电线束线带 固定带 扎线 电源线收线带 珠型扎带 水管座 扎带座 扎带扣 吊勾粘扣带 绑线带

22.USB座护盖 USB端口保护盖 USB端口防尘盖 MICRO USB防尘盖 MINI USB座护盖USB Type-C防尘盖 USB防尘盖 RJ-45防尘盖 RJ-11防尘盖 RJ-12防尘盖 RJ-22防尘盖 电源插头防尘盖 电源插头保护座 电源插头防尘座 电源插头防尘盖 光纤连接器护盖 光纤连接器护套 光纤防尘盖 PC板金手指防尘盖 HDMI防尘盖 Mini数位端子防尘盖 汽车点烟器防尘盖BBU防尘盖 DVI防尘盖 连接器盖 SIM Card Cap防尘盖 SD防尘盖 KVM防尘盖 CF防尘盖 防尘盖 端子盖 S端子盖 平衡端子盖 BNC绝缘座 SATA防尘盖 ESATA护盖 DP端子防尘盖 Mini D.P数位端子防尘盖 D.Type防尘盖 VGA防尘盖 IDE Connector防尘盖 PC端子防尘盖 端子防尘盖 1394端子防尘盖 零件盖 电源盖 机板电源保护盖 连接器座 PCMIC卡保护盖 面板 DDR防尘盖 D-Sub保护盖 高压防尘盖 SD保护盖 Micoro SD卡保护盖 SIM卡保护盖 防水帽盖 帽盖连接带 防水圈 电脑风扇防护盖 电脑风扇防尘座 电脑风扇框护垫 电脑风扇支架 开关遮板 光纤晶体座



# 电子电脑塑胶五金零件目录

23.插销 铆钉 尼龙铆钉 螺丝铆钉 散热片铆钉 塑料铆钉 电脑风扇铆钉 散热片扣件 弹簧铆钉 螺丝固定座 膨胀螺栓 墙塞 无帽鱼型膨胀管 墙面固定座 石膏板固定座

24.固定扣 门扣开关 机器门扣开关 弹簧固定座 旋转型门扣 门扣碰珠 磁铁门扣

55.工具 线扣工具 进口束线枪 旗型端子工具 国产束线枪 非绝缘端子工具 绝缘端子工具



# 电子电脑塑胶五金零件目录



1.LED间隔柱



2.LED导光柱



3.LED座



4.90°LED灯座



5.PC板间隔柱



6.塑料铜柱



7.排线固定座



8.PC板端子



9.仪表脚垫



10.塑料螺丝



11.PC板拉柄导槽



12.晶体管盖

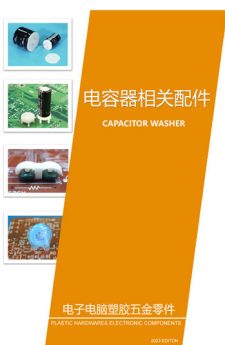

13.电容器垫片



14.热敏电阻座



15.陶瓷零件垫片



16.功率IC盖



# 电子电脑塑胶五金零件目录



17.孔塞



18.电源线扣



19.机箱把手



20.阻尼齿轮



21.电线扎带



22.USB座护盖



23.尼龙铆钉



24.门扣开关



55.工具

## 电子电脑塑胶五金零件

PLASTIC HARDWARE & ELECTRONIC COMPONENTS



南京诺金电气有限公司

Nanjing Nojinqing Electric Co., Ltd.

2021.03/17A

选型手册总目录

本公司保留因质量改进、后续开发或生产要求引起的设计更改权力。本产品目录为元件的详细说明，不能做担保依据。使用者有义务审核该元件是否符合应用范围的规定。



微信



QQ

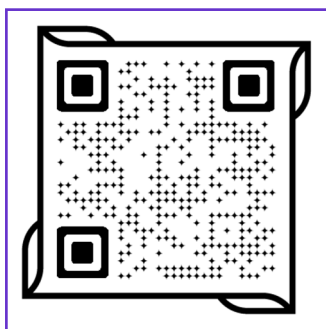

网站

## 南京诺金电气有限公司

Nanjing Nowking Electric Co., Ltd

- ◆ Tel: 025-85422485 85436028 85437901
- ◆ Wechat/Mobile :13770725488
- ◆ QQ:260678075
- ◆ E-mail: nk@nowking.com
- ◆ Http://www.nowking.com
- ◆ Http://www.kyphe.com