

陶瓷零件垫片

CERAMIC PARTS WASHER

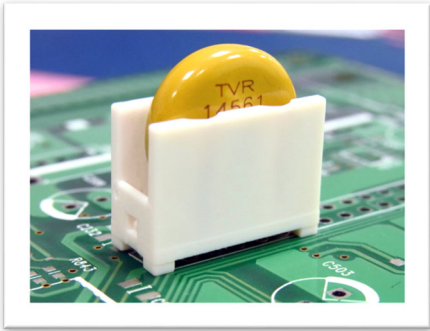

零件垫片

SHOULDER WASHER



PC板垫片

PCB WASHER



尼龙垫圈

WASHER

电子电脑塑胶五金零件

PLASTIC HARDWARE& ELECTRONIC COMPONENTS

2023 EDITON

陶瓷零件垫片 零件垫片 垫圈 华司 零件垫座 IC座 桥式整流座 跳线座 线圈座 滤波器垫片
 绝缘柱 螺丝垫片 滚轮 PC板垫片 球击缓冲垫片 尼龙垫圈 尼龙弹簧垫片 散热陶瓷垫片

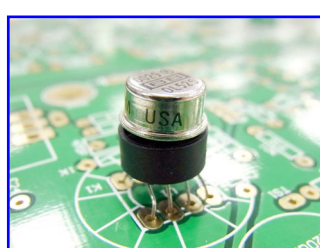
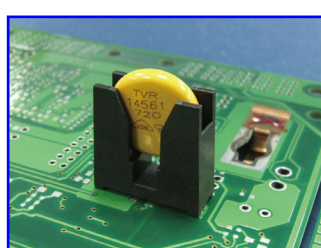
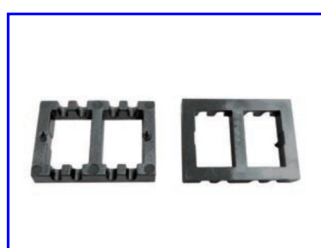
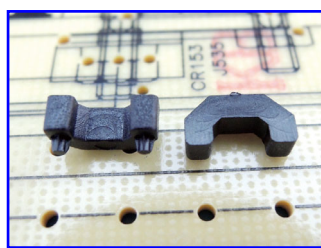
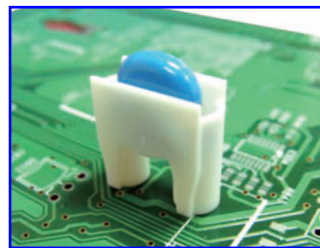
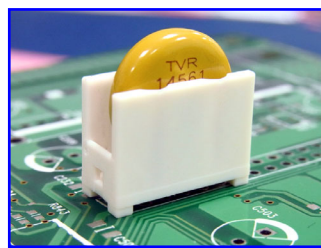
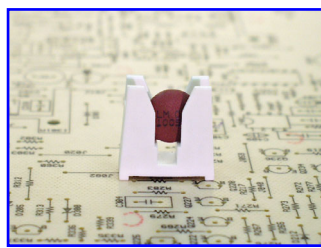
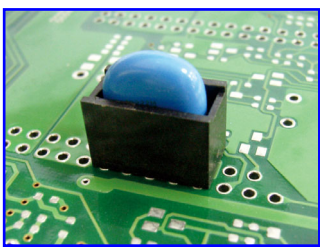
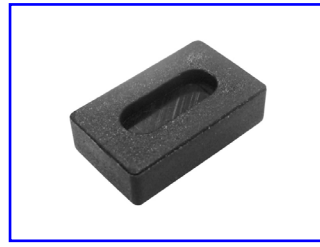
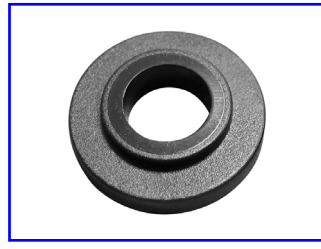
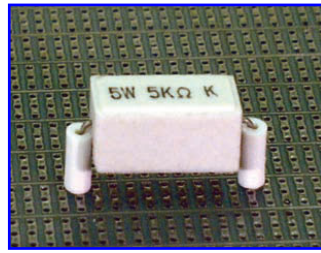
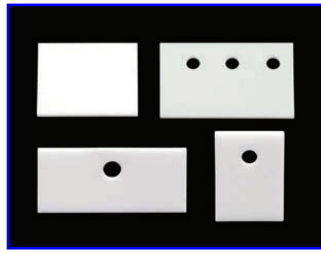
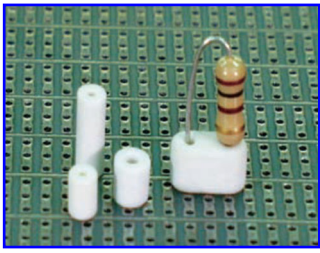

陶瓷零件垫片 零件垫片 垫圈 华司 零件垫座 IC座 桥式整流座 跳线座 线圈座 滤波器垫片
 绝缘柱 螺丝垫片 滚轮 PC板垫片 球击缓冲垫片 尼龙垫圈 尼龙弹簧垫片 散热陶瓷垫片

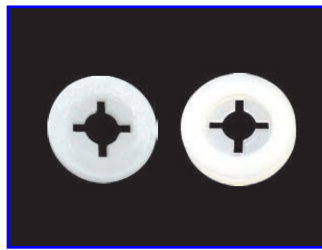
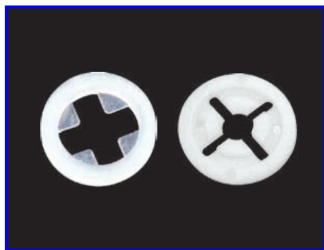
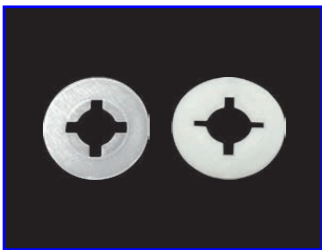
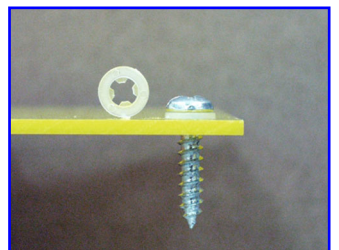
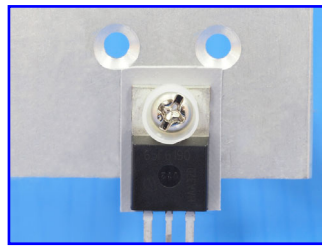
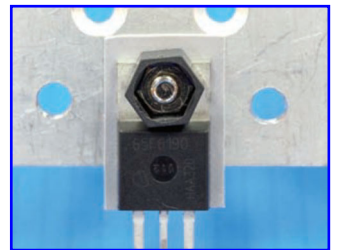
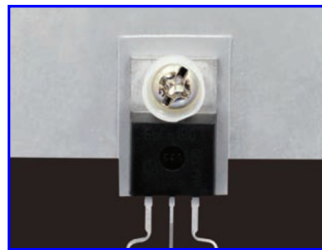
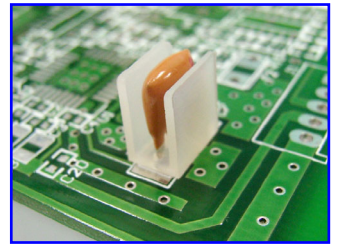
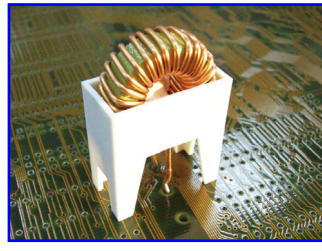
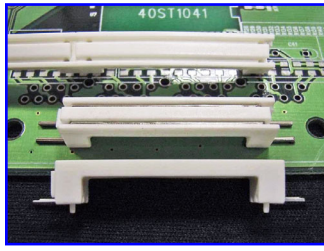
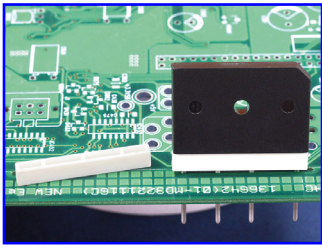
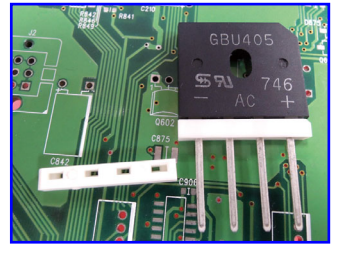
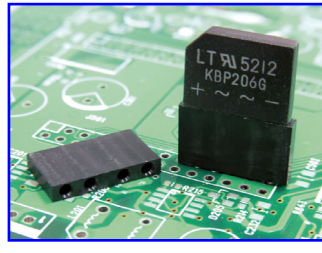
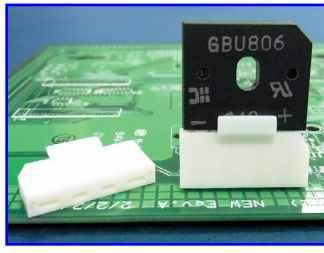
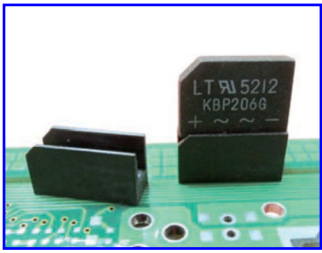

桥式整流座

陶瓷零件垫片 零件垫片 垫圈 华司 零件垫座 IC座 桥式整流座 跳线座 线圈座 滤波器垫片
 绝缘柱 螺丝垫片 滚轮 PC板垫片 球击缓冲垫片 尼龙垫圈 尼龙弹簧垫片 散热陶瓷垫片

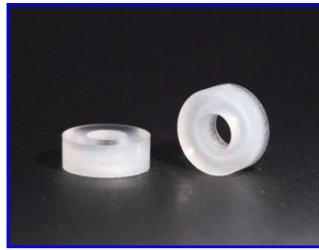
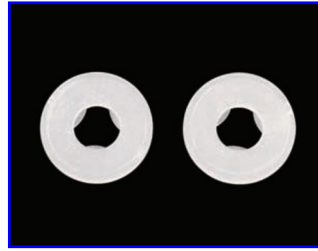
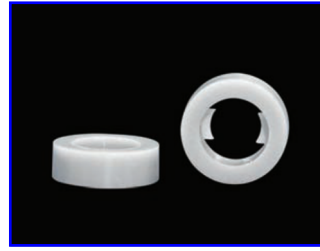
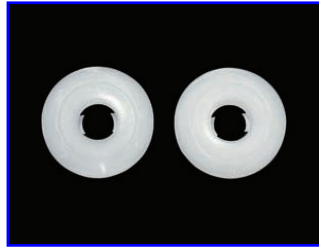
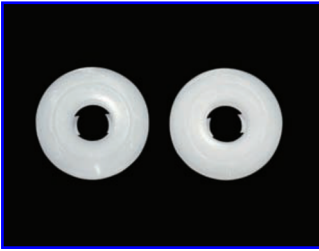
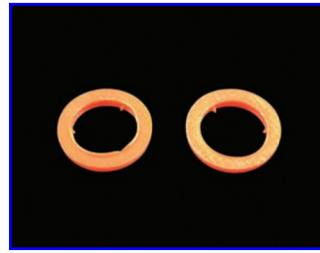

陶瓷零件垫片 零件垫片 垫圈 华司 零件垫座 IC座 桥式整流座 跳线座 线圈座 滤波器垫片
 绝缘柱 螺丝垫片 滚轮 PC板垫片 球击缓冲垫片 尼龙垫圈 尼龙弹簧垫片 散热陶瓷垫片

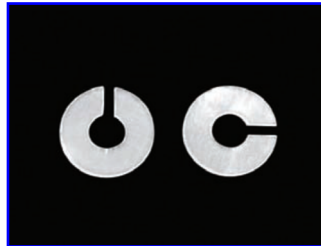
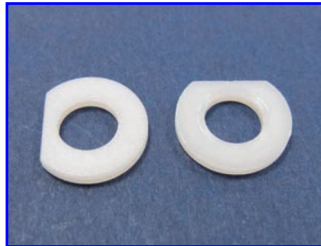
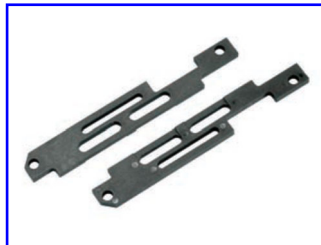
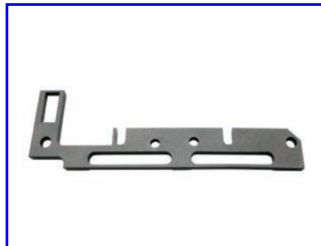
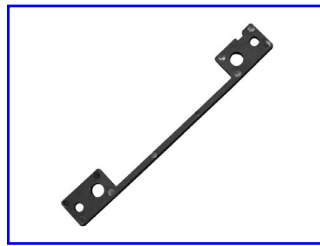
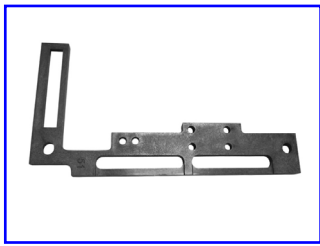

陶瓷零件垫片 零件垫片 垫圈 华司 零件垫座 IC座 桥式整流座 跳线座 线圈座 滤波器垫片
绝缘柱 螺丝垫片 滚轮 PC板垫片 球击缓冲垫片 尼龙垫圈 尼龙弹簧垫片 散热陶瓷垫片

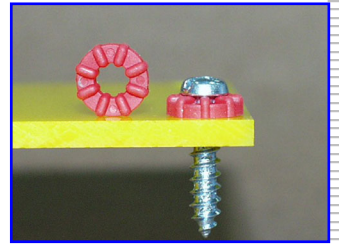
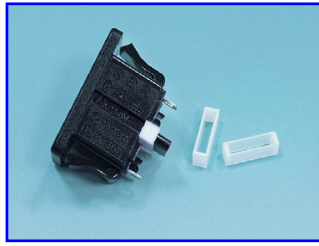

陶瓷零件垫片 零件垫片 垫圈 华司 零件垫座 IC座 桥式整流座 跳线座 线圈座 滤波器垫片
绝缘柱 螺丝垫片 滚轮 PC板垫片 球击缓冲垫片 尼龙垫圈 尼龙弹簧垫片 散热陶瓷垫片

陶瓷零件垫片 CERAMIC PARTS WASHER 垫圈 华司 零件垫片

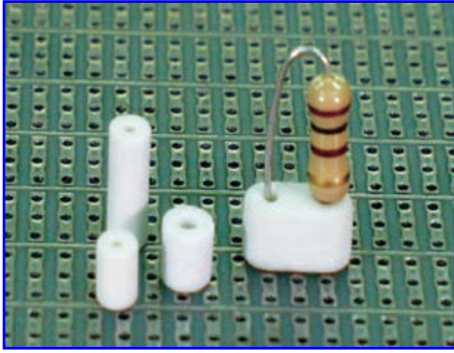

- ◆ MATERIAL : CERAMIC
- ◆ COLOR : NATURAL/WHITE
- ◆ UNIT: mm

用途：陶瓷零件垫片，用于零件，如高瓦特数电阻接脚之垫高，避免热气积存于PC板上。

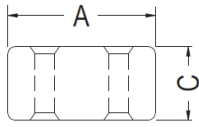
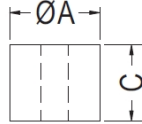
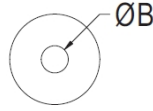
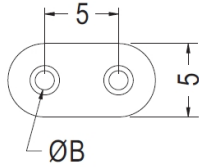

PART NO	A	B	C	PACKAGE
CHRS-6	10.0	1.3	5.0	2000

PART NO	A	B	C	PACKAGE
CHRS-1	3.8	1.0	4.5	2000
CHRS-2	3.8	1.0	9.0	2000
CHRS-3	4.5	1.8	3.0	2000
CHRS-4	4.5	1.8	4.5	2000
CHRS-5	4.5	1.8	9.0	2000
CHRS-7	2.6	0.9	6.9	2000
CHRS-8	2.5	1.1	3.1	2000
CHRS-9	4.1	1.9	15.4	2000
CHRS-10	4.1	1.9	13.0	1000
CHRS-15	4.0	1.6	15.0	1000
CHRS-16	4.5	1.8	2.0	2000

陶瓷零件垫片 CERAMIC PAD 垫圈 华司 零件垫片

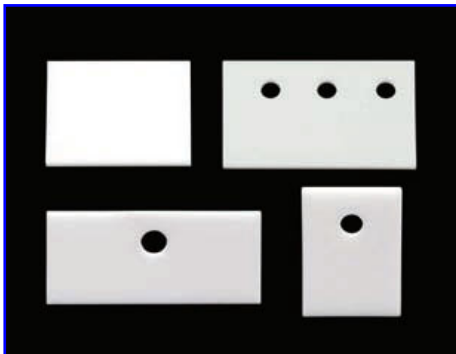

- ◆ MATERIAL : CERAMIC
- ◆ COLOR : NATURAL
- ◆ UNIT: mm

用途：陶瓷零件垫片，用于零件之绝缘散热，散热性佳。

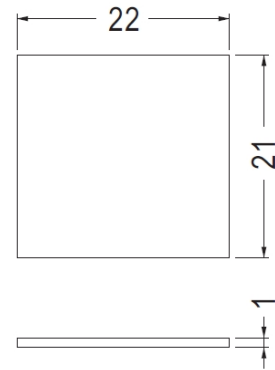
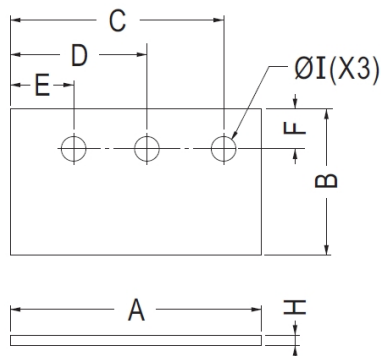

PART NO	PACKAGE
CHRS-14	100

PART NO	A	B	C	D	E	F	H	I	PACKAGE
CHRS-11	37.7	22.0	32.0	20.5	9.5	6.0	1.55	3.7	50
CHRS-12	34.8	20.0	28.8	17.3	5.8	4.0	1.0	3.7	100
CHRS-13	42.0	20.0	33.8	20.2	6.0	4.0	1.0	3.7	50
CHRS-17	30.0	13.6	-	15.0	-	4.5	1.0	3.5	100
CHRS-18	16.0	21.0	-	8.0	-	5.9	2.5	3.5	100

零件垫片 WASHER 垫圈 华司

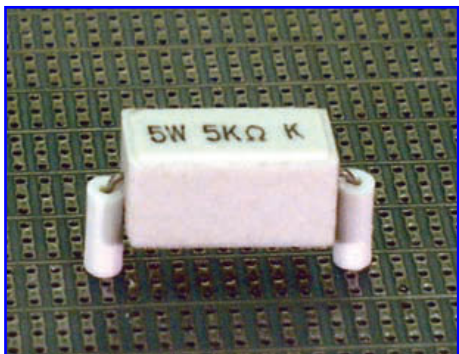

- ◆ MATERIAL : PTB (UL)
- ◆ FLAME CLASS : 94V-0
- ◆ COLOR : NATURAL
- ◆ UNIT: mm

用途：零件垫片，用于零件，如高瓦特数电阻接脚之垫高，避免热气积存于PC板上。

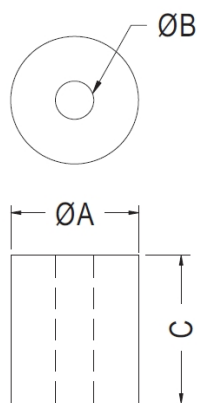

PART NO	A	B	C	PACKAGE
DPW01	4.0	1.4	4.2	2000
DPW02	4.5	1.8	4.2	2000
DPW03	4.0	1.4	8.0	1000
DPW04	4.0	1.3	3.0	2000
DPW05	3.5	1.3	3.6	2000
DPW06	5.0	2.0	2.0	2000
DPW07	3.2	1.4	2.5	2000
DPW08	3.2	1.4	1.0	2000
DPW09	2.4	1.3	3.1	2000
DPW10	4.4	1.6	7.0	1000
DPW11	2.5	1.25	5.0	2000
DPW12	2.2	0.8	5.0	2000
DPW13	2.8	1.3	1.8	2000
DPW22	2.5	1.1	2.5	2000
DPW24	2.2	0.9	10.5	1000

零件垫片



- ◆ MATERIAL : NYLON 6 (UL)
- ◆ FLAME CLASS : 94V-0/94V-2
- ◆ COLOR : NATURAL
- ◆ UNIT: mm

用途：零件垫片，用于零件，如高瓦特数电阻接脚之垫高，避免热气积存于PC板上。

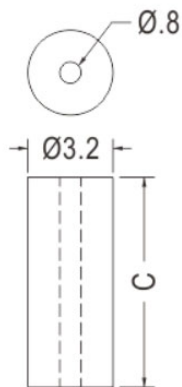

PART NO	C	PACKAGE
DPW23	7.9	1000
DPW25	1.5	2000

零件垫片 WASHER 垫圈 华司



- ◆ MATERIAL : NYLON 66 (UL)
- ◆ FLAME CLASS : 94V-0/94V-2
- ◆ COLOR : NATURAL/BLACK
- ◆ UNIT: mm

用途：零件垫片，用于零件，作为零件之垫片。

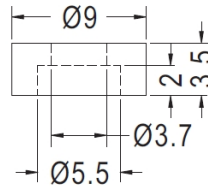
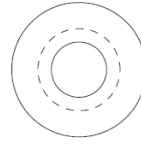

PART NO	PACKAGE
LTWC-01	2000

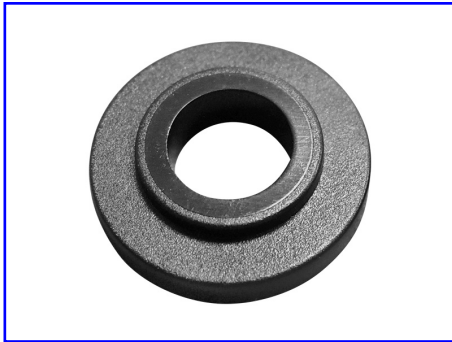

- ◆ MATERIAL : PC+ABS/NYLON 66(UL) 用途：零件垫片，作为零件之垫片。
- ◆ FLAME CLASS : 94V-0/94V-2
- ◆ COLOR : NATURAL/BLACK
- ◆ UNIT: mm

PART NO	A	B	C	D	E	MATERIAL	PACKAGE
LTWC-02	15.0	9.9	4.2	2.0	1.5	NYLON 66	2000
LTWC-08	13.0	8.5	5.5	1.0	2.0	PC+ABS	2000
LTWC-09	13.0	8.5	5.5	1.0	7.0	PC+ABS	2000
LTWC-10	14.6	10.1	4.5	0.4	1.9	PC+ABS	2000
LTWC-11	7.6	5.84	3.25	1.27	0.38	NYLON 66	2000
LTWC-15	19.2	9.4	6.5	0.8	1.2	NYLON 66	2000
LTWC-16	15.0	10.0	5.5	1.2	2.5	NYLON 66	2000
LTWC-19	9.52	6.35	4.32	0.81	0.81	NYLON 66	2000

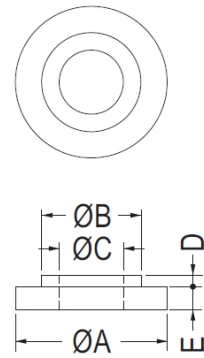

PART NO	A	B	C	D	E	PACKAGE
LTWC-05	16.8	12.5	9.5	2.0	2.0	1000
LTWC-06	11.1	7.9	6.4	0.81	0.81	1000

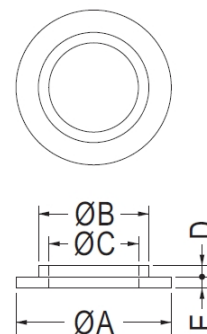



用途：零件垫片，作为零件之垫片。

- ◆ MATERIAL : NYLON 66 (UL)
- ◆ FLAME CLASS : 94V-0/04V-2
- ◆ COLOR : NATURAL/BLACK
- ◆ UNIT: mm

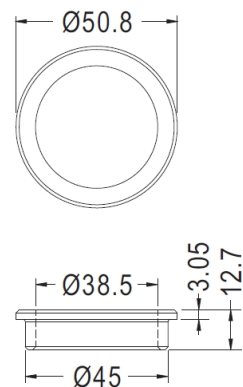

PART NO	PACKAGE
LTWC-03	1000



- ◆ MATERIAL : NYLON 66 (UL)
- ◆ FLAME CLASS : 94V-0/04V-2
- ◆ COLOR : NATURAL/BLACK
- ◆ UNIT: mm

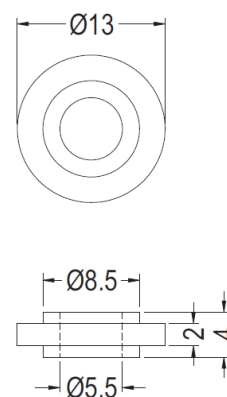

PART NO	PACKAGE
LTWC-12	2000



用途：零件垫片，作为零件之垫片。

- ◆ MATERIAL : PPS (UL)
- ◆ FLAME CLASS : 94V-0
- ◆ COLOR : NATURAL(BROWN)/BLACK
- ◆ UNIT: mm

- ◆ MATERIAL : NYLON 66 (UL)
- ◆ FLAME CLASS : 94V-0/94V-2
- ◆ COLOR : NATURAL/BLACK
- ◆ UNIT: mm

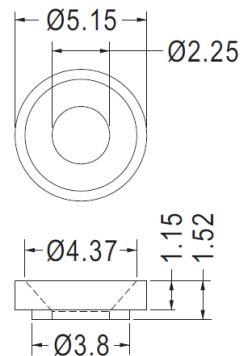
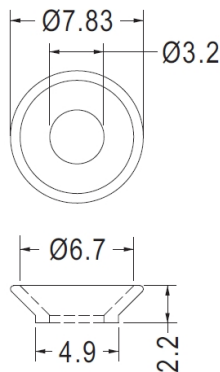

PART NO	PACKAGE
LTWC-04	2000

PART NO	PACKAGE
LTWC-13	1000

零件垫片 WASHER 垫圈 华司



用途：零件垫片，螺丝垫片，耐热性良好。

- ◆ MATERIAL : NYLON 66 (UL)
- ◆ FLAME CLASS : 94V-0/94V-2
- ◆ COLOR : NATURAL/BLACK
- ◆ UNIT: mm

- ◆ MATERIAL : POM (UL)
- ◆ FLAME CLASS : 94HB
- ◆ COLOR : NATURAL/BLACK
- ◆ UNIT: mm

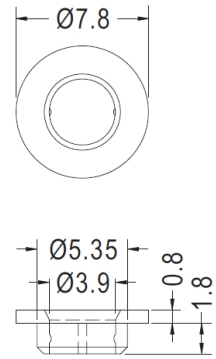
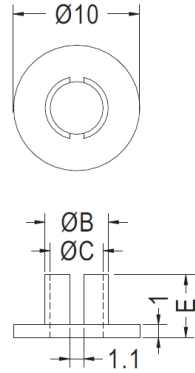

可配合M4螺絲

PART NO	B	C	E	PACKAGE
LTWC-14	5.0	4.2	5.0	2000
LTWC-17	6.0	5.0	6.0	2000

PART NO	PACKAGE
LTWC-18	2000

零件垫座 PARTS HOUSING



- ◆ MATERIAL : NYLON 66 (UL)
- ◆ FLAME CLASS : 94V-0/04V-2
- ◆ COLOR : NATURAL/BLACK
- ◆ UNIT: mm

用途：零件垫座，用于零件之垫高。

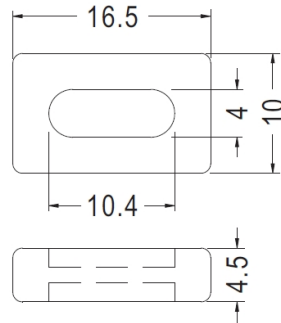

PART NO	PACKAGE
PAHO-001	1000

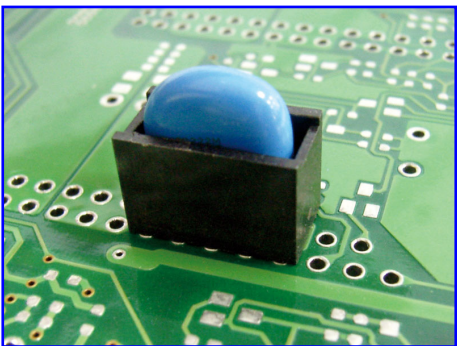

- ◆ MATERIAL : PPS (UL)
- ◆ FLAME CLASS : 94V-0
- ◆ COLOR : BLACK
- ◆ UNIT: mm

用途：零件垫片，用于零件之垫座。

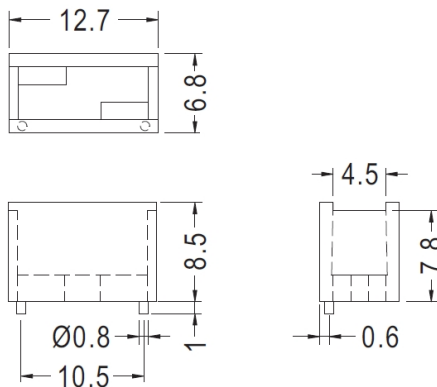

PART NO	PACKAGE
PAHO-027	1000

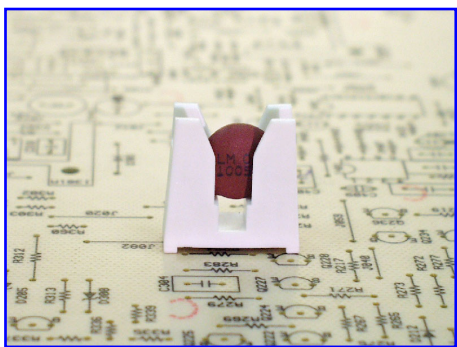

- ◆ MATERIAL : PBT (UL)
- ◆ FLAME CLASS : 94V-0
- ◆ COLOR : NATURAL
- ◆ UNIT: mm

用途：零件垫片，用于零件接脚之垫高与保护。

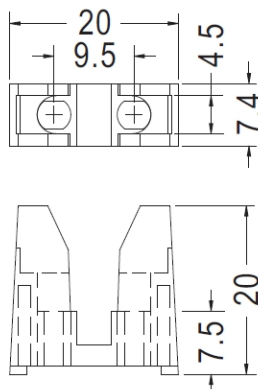

PART NO	PACKAGE
PAHO-033	500

零件垫座 PARTS HOUSING

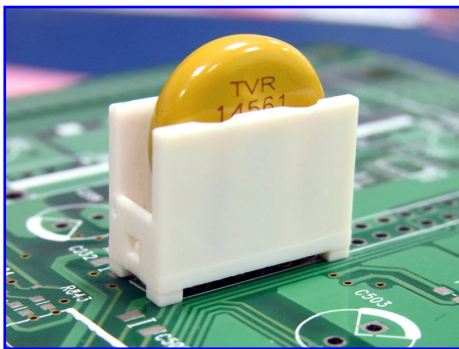

- ◆ MATERIAL : PBT(UL)/PPS(UL)
- ◆ FLAME CLASS : 94V-0
- ◆ COLOR : NATURAL/BLACK
- ◆ UNIT: mm

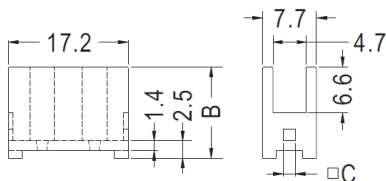
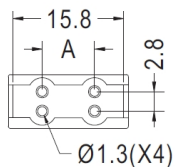

用途：零件垫座，用于零件接脚之垫高与保护。

PART NO	A	B	C	PACKAGE
PAHO-034	7.2	14.5	-	500
PAHO-035	7.5	13.1	1.7	500
PAHO-037	7.5	13.1	-	500

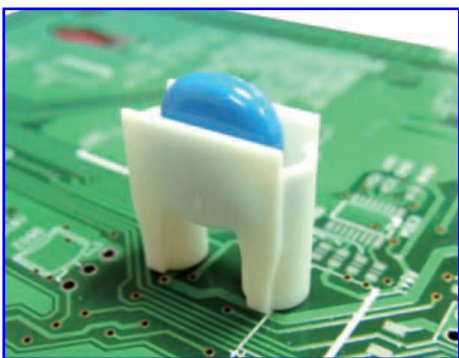

- ◆ MATERIAL : NYLON 66 (UL)
- ◆ FLAME CLASS : 94V-0/94V-2
- ◆ COLOR : NATURAL/BLACK
- ◆ UNIT: mm

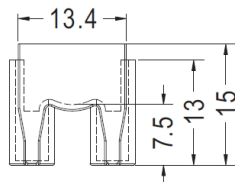
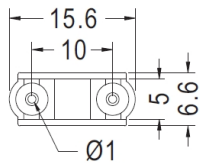

用途：零件垫座，用于零件接脚之垫高与保护。

PART NO	PACKAGE
PAHO-036	500



- ◆ MATERIAL : PBT (UL)
- ◆ FLAME CLASS : 94V-0/94V-2
- ◆ COLOR : NATURAL
- ◆ UNIT: mm

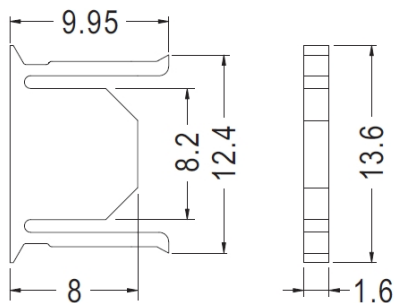

用途：零件垫座，做为零件之盖片。

PART NO	PACKAGE
PAHO-048	1000

零件垫座 PARTS HOUSING

用途：零件垫座，用于电源供应器，球击测试的保护。

- ◆ MATERIAL : PC (UL)
- ◆ FLAME CLASS : 94V-0
- ◆ COLOR : BLACK
- ◆ UNIT: mm

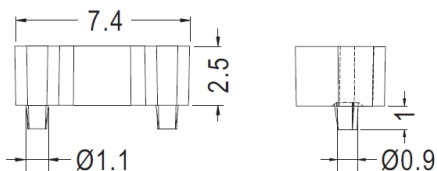
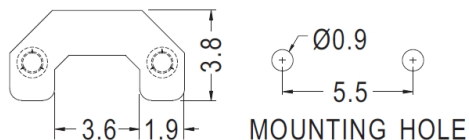
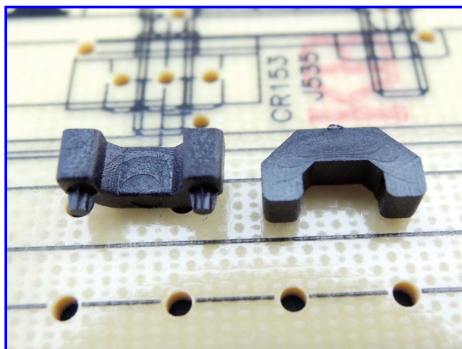

PART NO	PACKAGE
PAHO-051	2000

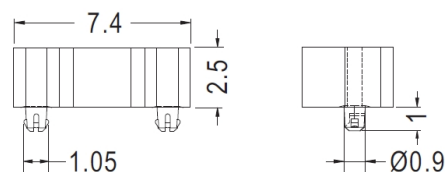
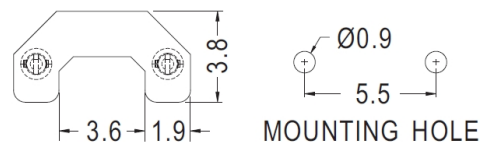

PART NO	PACKAGE
PAHO-052	2000

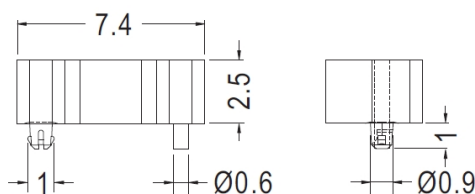
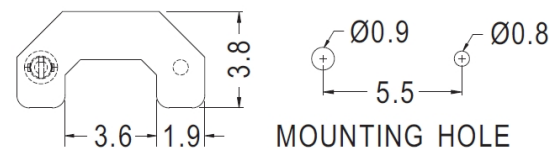

PART NO	PACKAGE
PAHO-053	2000

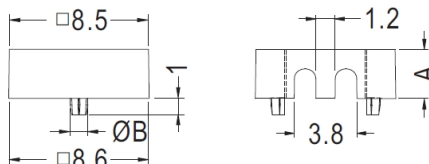
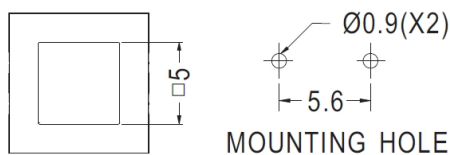

PART NO	B	C	PACKAGE
PAHO-054	2.5	0.9	2000
PAHO-055	3.0	1.08	2000

零件垫座 PARTS HOUSING

用途：零件垫座，用于电源供应器，球击测试的保护。

- ◆ MATERIAL : PC (UL)
- ◆ FLAME CLASS : 94V-0
- ◆ COLOR : BLACK
- ◆ UNIT: mm

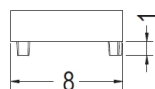
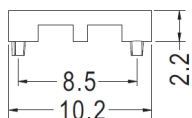
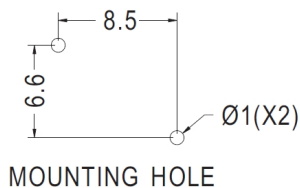
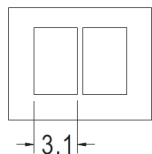

PART NO	PACKAGE
PAHO-056	2000

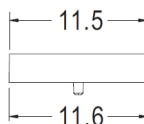
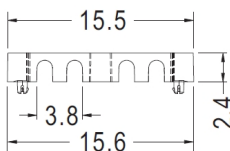
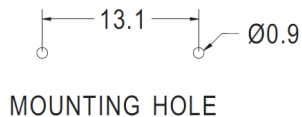
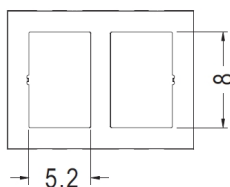
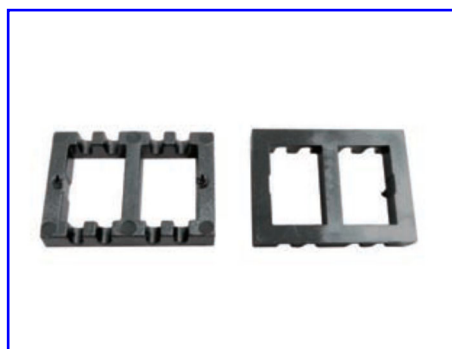

PART NO	PACKAGE
PAHO-057	1000

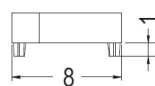
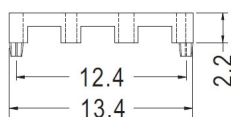
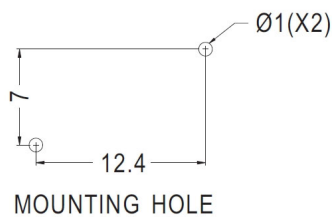
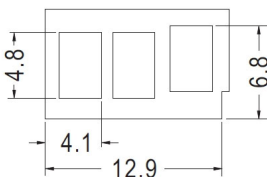

PART NO	PACKAGE
PAHO-058	1000

零件垫座 PARTS HOUSING



- ◆ MATERIAL : PC (UL)
- ◆ FLAME CLASS : 94V-0
- ◆ COLOR : BLACK
- ◆ UNIT: mm

用途：零件垫座，用于电源供应器，球击测试的保护。

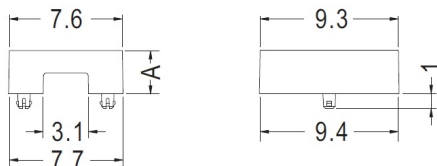
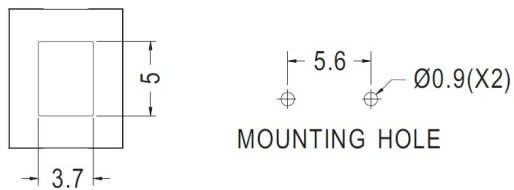

PART NO	A	PACKAGE
PAHO-059	2.4	2000
PAHO-060	2.9	2000

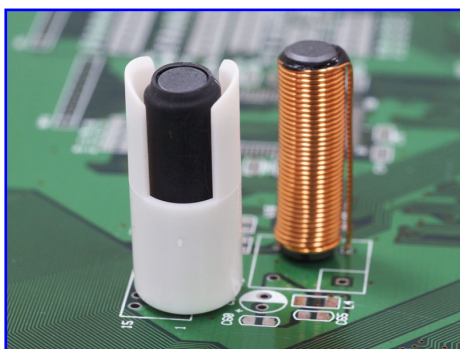

- ◆ MATERIAL : NYLON 66 (UL)
- ◆ FLAME CLASS : 94V-0/94V-2
- ◆ COLOR : NATURAL/BLACK/WHITE
- ◆ UNIT: mm

用途：零件垫座，用于电杆器绝缘并保护。

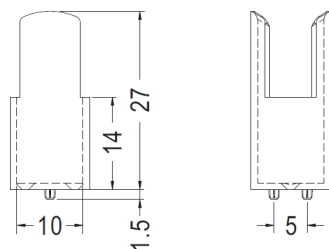

PART NO	PACKAGE
PAHO-077	500

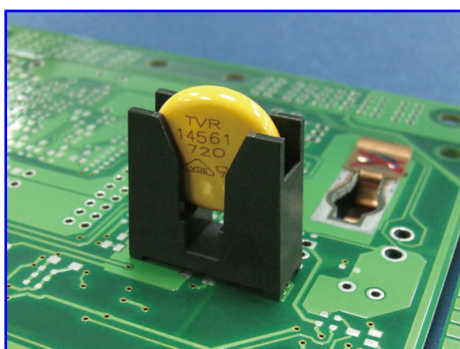

- ◆ MATERIAL : NYLON 66 (UL)
- ◆ FLAME CLASS : 94V-0/94V-2
- ◆ COLOR : NATURAL/BLACK
- ◆ UNIT: mm

用途：零件垫座，用于零件接脚之垫高与保护。

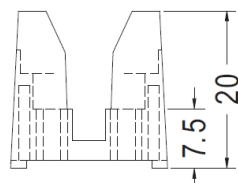
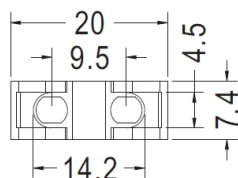

PART NO	PACKAGE
PAHO-078	1000

IC座 IC HOUSING

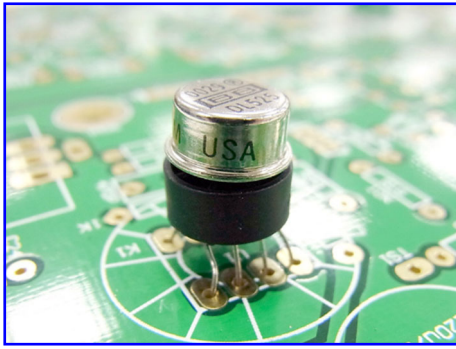

- ◆ MATERIAL : NYLON 66 (UL)
- ◆ FLAME CLASS : 94V-0/94V-2
- ◆ COLOR : NATURAL/BLACK
- ◆ UNIT: mm

用途： IC座, 8pin铁壳IC之架高与绝缘。

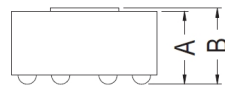
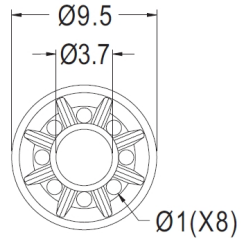

PART NO	A	B	PACKAGE
IC1001	2.0	2.2	1000
IC1002	4.8	5.0	1000

桥式整流座 BRIDGE RECTIFIER HOUSING

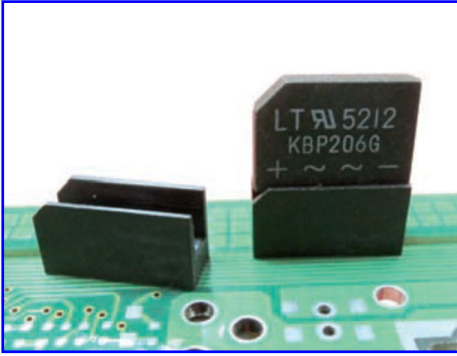

- ◆ MATERIAL : PBT (UL)
- ◆ FLAME CLASS : 94V-0
- ◆ COLOR : BLACK/NATURAL
- ◆ UNIT: mm

用途： 桥式整流座，保护桥式整流器
立于PC板上，使接脚不弯曲、
折断、短路、且高度一致。

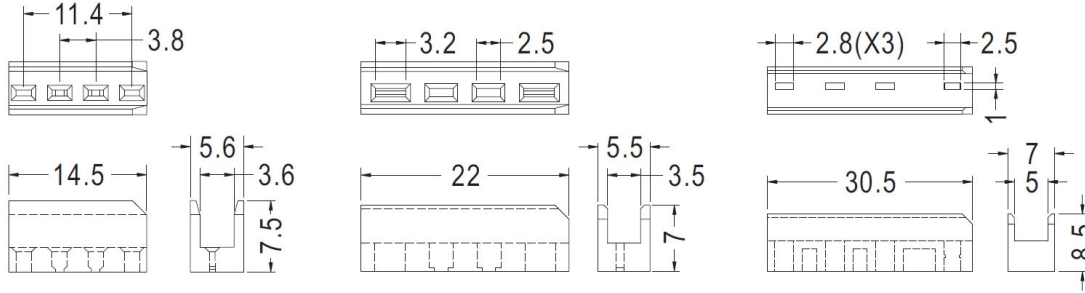

PART NO	PACKAGE
LBG03	500

PART NO	PACKAGE
LBG01	500

PART NO	PACKAGE
LBG02	500

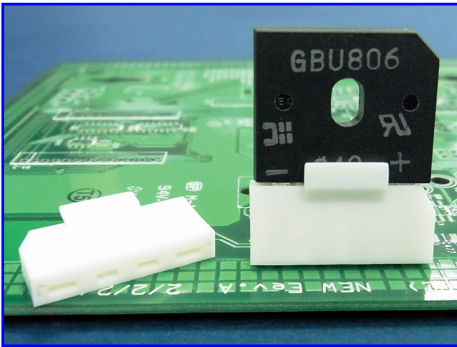

- ◆ MATERIAL : NYLON 66 (UL)
- ◆ FLAME CLASS : 94V-0/94V-2
- ◆ COLOR : NATURAL/BLACK/WHITE
- ◆ UNIT: mm

用途： 桥式整流座，保护桥式整流器
立于PC板上，使接脚不弯曲、
折断、短路、且高度一致。

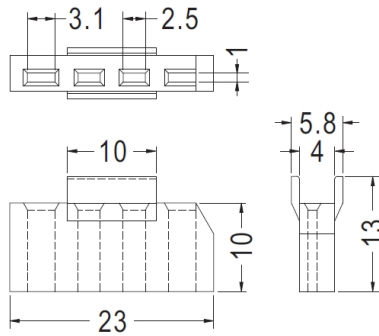

PART NO	PACKAGE
LBG05	500

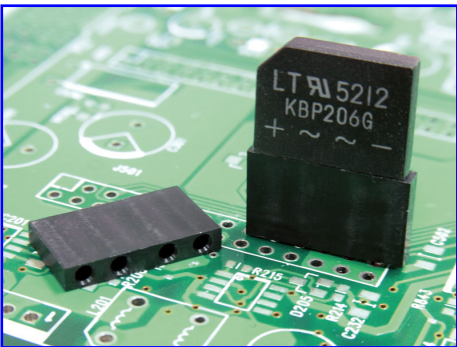

- ◆ MATERIAL : PBT (UL)
- ◆ FLAME CLASS : 94V-0
- ◆ COLOR : BLACK
- ◆ UNIT: mm

用途： 桥式整流座，保护桥式整流器
立于PC板上，使接脚不弯曲、
折断、短路、且高度一致。

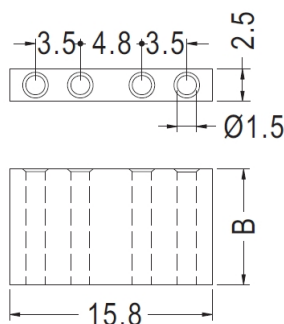

PART NO	B	PACKAGE
LBG04	9.0	1000
LBG06	18.0	1000

桥式整流座 BRIDGE RECTIFIER HOUSING

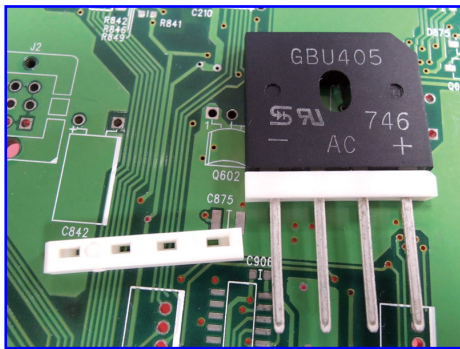

- ◆ MATERIAL : PBT (UL)
- ◆ FLAME CLASS : 94V-0
- ◆ COLOR : NATURAL
- ◆ UNIT: mm

用途： 桥式整流座，保护桥式整流器立于PC板上，使接脚不弯曲、折断、短路、且高度一致。

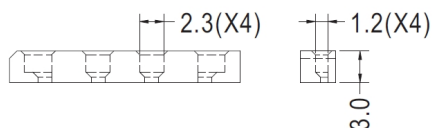
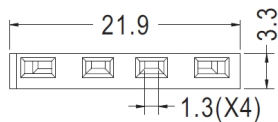

PART NO	PACKAGE
LBG07	1000

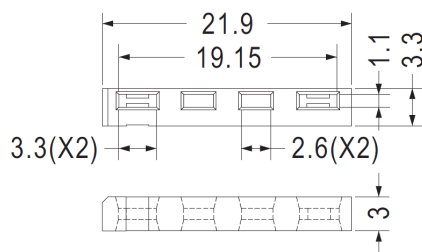

PART NO	PACKAGE
LBG10	1000

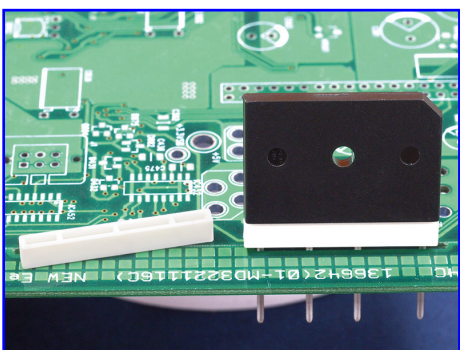

- ◆ MATERIAL : PBT (UL)
- ◆ FLAME CLASS : 94V-0
- ◆ COLOR : WHITE
- ◆ UNIT: mm

用途： 桥式整流座，保护桥式整流器立于PC板上，使接脚不弯曲、折断、短路、且高度一致。

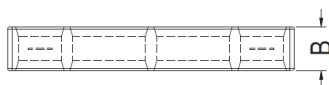
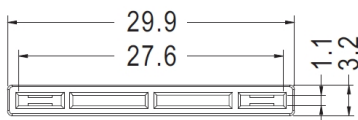

PART NO	B	PACKAGE
LBG08	4.5	1000
LBG09	8.5	1000

跳线座 JUMPER HOUSING

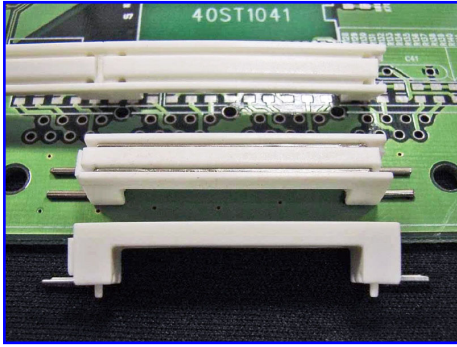

- ◆ MATERIAL : PBT (UL)
- ◆ FLAME CLASS : 94V-0
- ◆ COLOR : NATURAL
- ◆ UNIT: mm

用途：跳线座，立于PC板上，将两跳线做隔离与保护固定用。

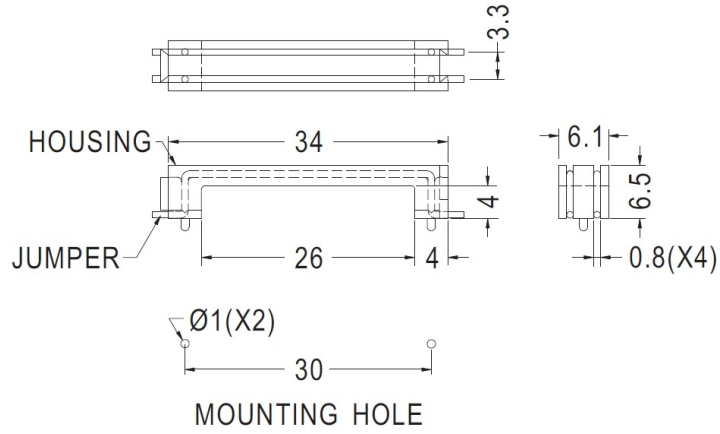

PART NO	PACKAGE
JUPZ-1	1000

线圈座 COIL HOLDER

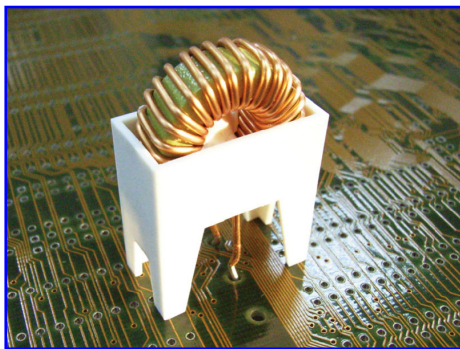

- ◆ MATERIAL : PBT (UL)
- ◆ FLAME CLASS : 94V-0
- ◆ COLOR : NATURAL
- ◆ UNIT: mm

用途：线圈座，用于零件接脚之垫高与保护。

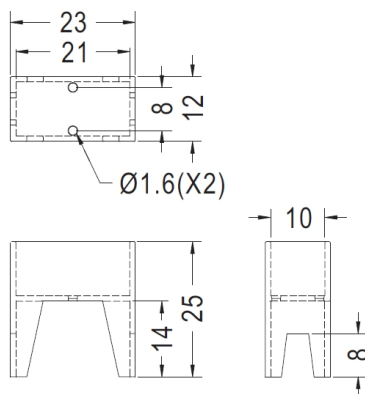

PART NO	PACKAGE
LTRMH-2	500

滤波器垫片 CRYSTAL WASHER 垫圈 华司

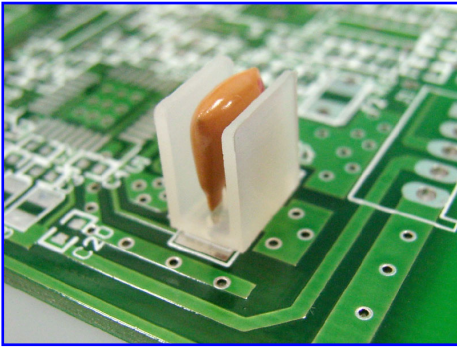

- ◆ MATERIAL : NYLON 66 (UL)
- ◆ FLAME CLASS : 94V-0/94V-2
- ◆ COLOR : NATURAL/BLACK
- ◆ UNIT: mm

用途：滤波器垫片，用于滤波器绝缘，立于PC板上，且高度一致增加可靠度。

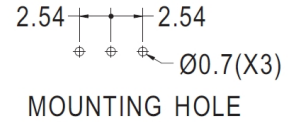
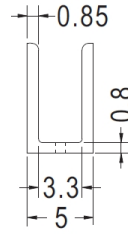
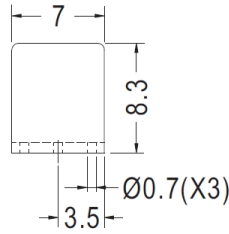

MOUNTING HOLE

PART NO	PACKAGE
LQCL-1	1000

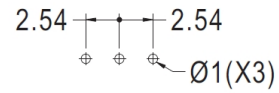
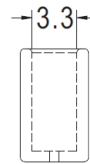
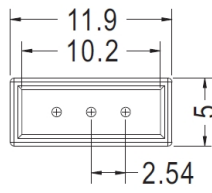

MOUNTING HOLE

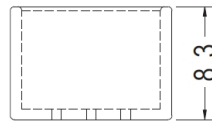

PART NO	PACKAGE
LQCL-2	1000

绝缘柱 ROUNDER WASHER 垫圈 垫片 华司



- ◆ MATERIAL : NYLON 66 (UL)
- ◆ FLAME CLASS : 94V-0/94V-2
- ◆ COLOR : NATURAL/BLACK
- ◆ UNIT: mm

用途: 绝缘柱, 用于零件接脚之垫高与保护。

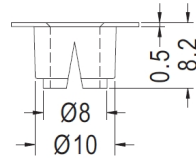
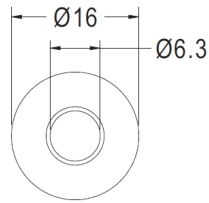

PART NO	PACKAGE
RDSC-01	1000

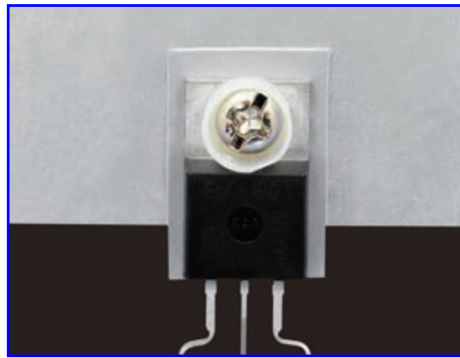

- ◆ MATERIAL : NYLON 46 (UL)/PPS(UL)
- ◆ FLAME CLASS : 94V-0
- ◆ COLOR : NATURAL
- ◆ UNIT: mm

用途: 绝缘柱, 用于螺丝之绝缘使用。

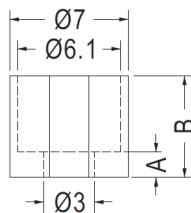

PART NO	A	B	PACKAGE
RDSC-11	1.5	6.0	2000
RDSC-12	1.4	3.5	2000
RDSC-18	0.8	3.8	2000
RDSC-19	0.3	2.3	2000
RDSC-20	0.3	2.3	2000
RDSC-22	0.3	1.9	2000

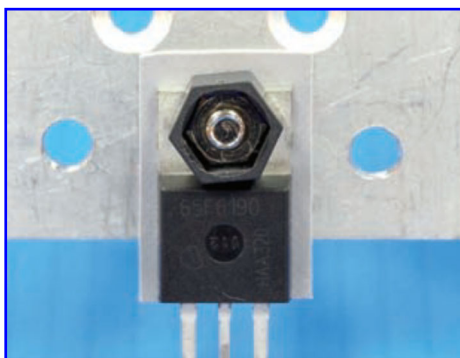

- ◆ MATERIAL : NYLON 46 (UL)/PPS(UL)
- ◆ FLAME CLASS : 94V-0
- ◆ COLOR : NATURAL
- ◆ UNIT: mm

用途: 绝缘柱, 用于M3螺母之绝缘使用。

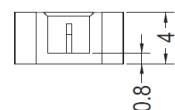
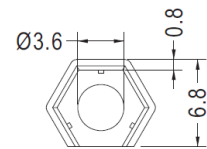
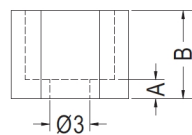

PART NO	A	B	PACKAGE
RDSC-13	1.5	6.4	2000
RDSC-14	0.8	5.2	2000

PART NO	PACKAGE
RDSC-74	2000

绝缘柱 ROUNDER WASHER 垫圈 垫片 华司

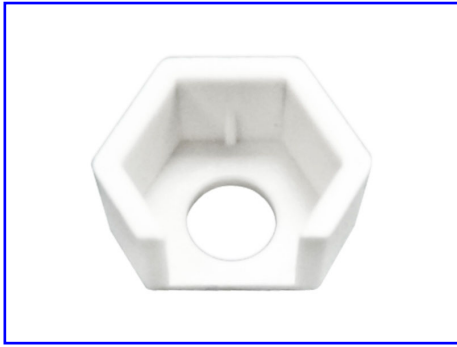

- ◆ MATERIAL : NYLON 46 (UL)
- ◆ FLAME CLASS : 94V-0
- ◆ COLOR : NATURAL
- ◆ UNIT: mm

用途：垫片，用于M3螺母之绝缘使用。

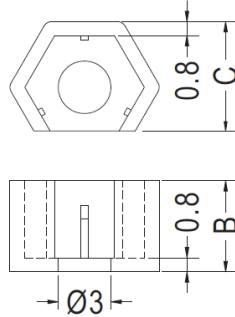

PART NO	B	C	PACKAGE
RDSC-15	5.2	6.25	2000
RDSC-16	4.0	5.8	2000
RDSC-17	4.0	6.25	2000



- ◆ MATERIAL : NYLON 66 (UL)
- ◆ FLAME CLASS : 94V-0/94V-2
- ◆ COLOR : NATURAL/BLACK
- ◆ UNIT: mm

用途：绝缘柱，用于零件之绝缘使用。

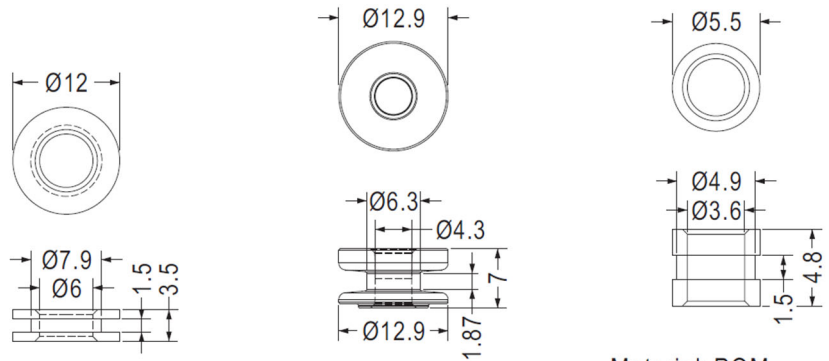

• Material: POM

PART NO	PACKAGE
RDSC-34	1000

PART NO	PACKAGE
RDSC-24	1000

PART NO	PACKAGE
RDSC-73	1000

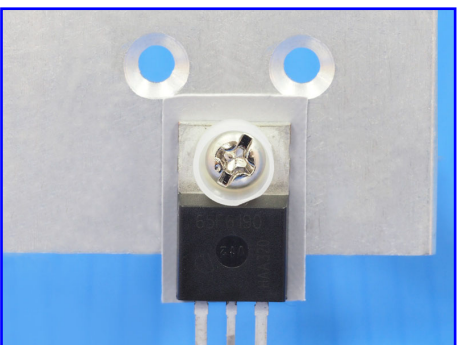

- ◆ MATERIAL : NYLON 46 (UL)
- ◆ FLAME CLASS : 94V-0
- ◆ COLOR : NATURAL
- ◆ UNIT: mm

用途：垫片，用于M3螺丝或螺母之绝缘使用。

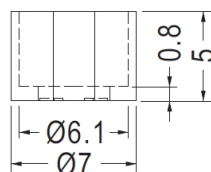
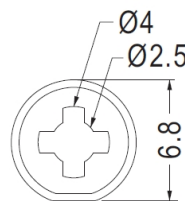

PART NO	PACKAGE
RDSC-35	1000

绝缘柱 ROUNDER WASHER 垫圈 垫片 华司



- ◆ MATERIAL : NYLON 66 (UL)/ NYLON 6(UL)/PC (UL)
- ◆ FLAME CLASS : 94V-0/94V-2
- ◆ COLOR : NATURAL/BLACK
- ◆ UNIT: mm

用途：绝缘柱，做为PC板与机板之绝缘使用。

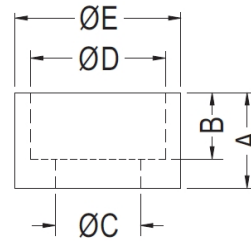

PART NO	A	B	C	D	E	PACKAGE
RDSC-36	4.9	3.8	3.2	5.7	7.0	2000
RDSC-37	4.6	3.2	4.1	6.5	8.0	2000
RDSC-38	10.0	7.0	3.0	8.5	11.0	1000
RDSC-39	3.1	2.1	3.0	5.5	7.5	2000
RDSC-40	3.0	1.5	3.7	7.4	9.4	2000
RDSC-41	4.6	3.6	3.6	7.6	9.1	2000
RDSC-42	4.0	3.0	2.9	6.3	7.8	2000
RDSC-43	4.2	2.7	3.2	5.3	8.74	2000
RDSC-44	6.5	6.0	6.0	8.0	9.0	2000
RDSC-45	7.1	5.1	4.8	8.9	15.7	2000
RDSC-46	5.1	4.0	7.0	10.0	12.0	2000
RDSC-47	3.8	2.25	3.4	5.95	8.0	2000

PART NO	A	B	C	D	E	PACKAGE
RDSC-48	4.8	3.3	3.4	6.5	9.5	2000
RDSC-49	3.8	3.05	3.2	5.4	7.0	2000
RDSC-50	6.4	3.4	3.2	5.0	7.0	2000
RDSC-51	6.0	3.0	2.8	5.1	7.5	2000
RDSC-52	4.8	2.5	6.8	4.5	12.5	2000
RDSC-53	4.5	3.75	3.1	4.2	6.0	2000
RDSC-54	6.5	6.0	3.5	6.0	8.0	2000
RDSC-55	3.75	2.65	3.2	5.4	7.0	2000
RDSC-56	2.3	1.7	3.25	5.5	6.7	2000
RDSC-57	5.0	4.6	-	4.5	5.2	2000
RDSC-69	2.5	2.0	3.5	6.0	7.0	2000
RDSC-70	5.1	4.0	3.2	10.0	12.0	2000
RDSC-71	3.5	3.0	-	7.0	8.7	2000
RDSC-72	20.0	17.5	5.2	14.0	17.0	1000

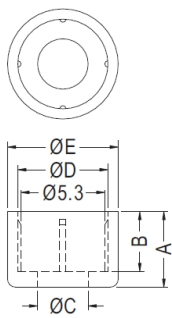

RDSC-36

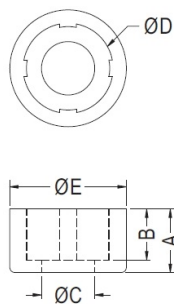

RDSC-49 RDSC-50 RDSC-51

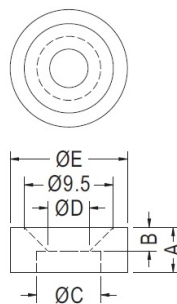

RDSC-52

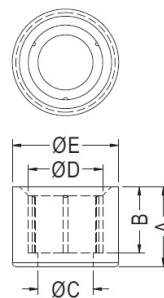

RDSC-53

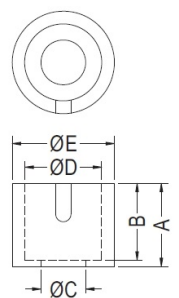

RDSC-54

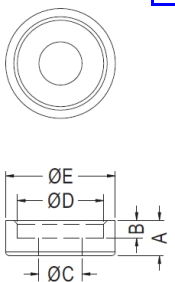

RDSC-40
RDSC-43

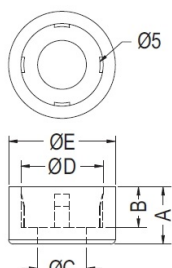

RDSC-55

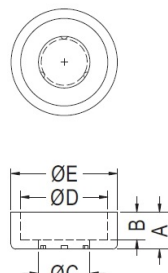

RDSC-56

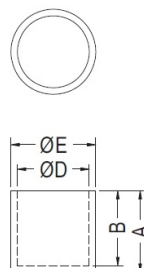

RDSC-57

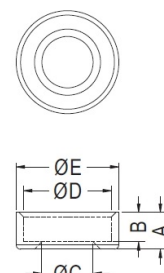

RDSC-69

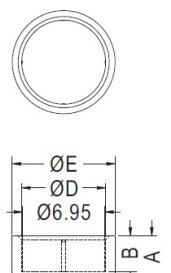

RDSC-71

绝缘柱 ROUNDER WASHER 垫圈 垫片 华司



- ◆ MATERIAL : PC (UL)
- ◆ FLAME CLASS : 94V-0/94V-2
- ◆ COLOR : TRANSPARENT
- ◆ UNIT: mm

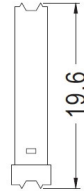
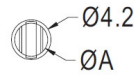

PART NO	B	PACKAGE
RDSC-65	3.5	1000
RDSC-66	3.0	1000

用途：绝缘柱，做为PC板与机板之绝缘使用。

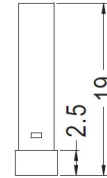
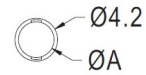

PART NO	B	PACKAGE
RDSC-61	3.5	1000
RDSC-62	3.0	1000

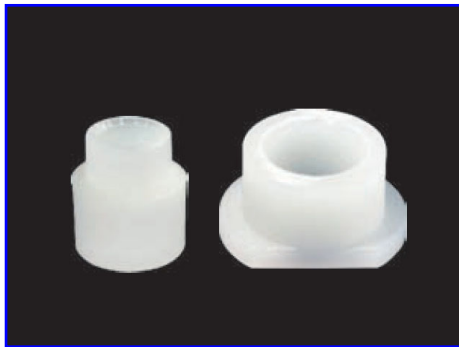

- ◆ MATERIAL : NYLON 66 (UL)
- ◆ FLAME CLASS : 94V-0/94V-2
- ◆ COLOR : NATURAL/BLACK
- ◆ UNIT: mm

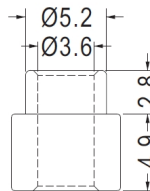
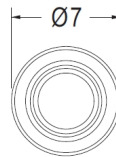

PART NO	PACKAGE
TORC-267	2000

用途：绝缘柱，用于零件之绝缘使用。

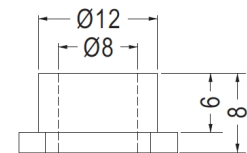
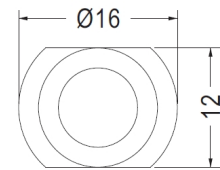

PART NO	PACKAGE
RDSC-68	1000

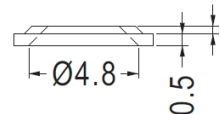
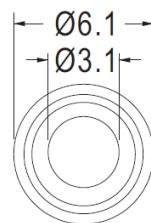
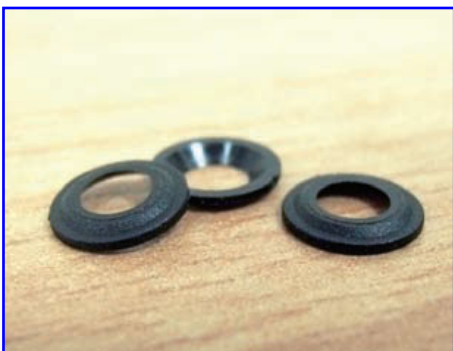

PART NO	PACKAGE
TORC-268	2000

绝缘柱 ROUNDER WASHER 垫圈 垫片 华司



- ◆ MATERIAL : PC (UL)
- ◆ FLAME CLASS : 94V-2
- ◆ COLOR : NATURAL
- ◆ UNIT: mm

用途：绝缘柱，用于零件之绝缘使用。

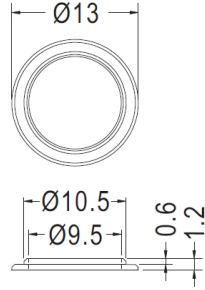

PART NO	PACKAGE
RDSC-10	1000



- ◆ MATERIAL : NYLON 66 (UL)/PPS(UL)
- ◆ FLAME CLASS : 94V-0
- ◆ COLOR : NATURAL/BLACK
- ◆ UNIT: mm

用途：绝缘柱，做为PC板与机板之绝缘使用。

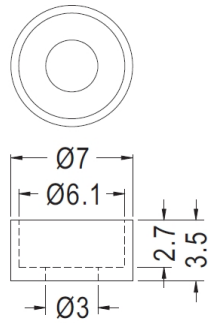

PART NO	PACKAGE
TORC-270	2000

螺丝垫片 CUP WASHER 垫圈 垫片 华司



- ◆ MATERIAL : PC (UL)
- ◆ FLAME CLASS : 94V-0/94V-2
- ◆ COLOR : NATURAL
- ◆ UNIT: mm

用途: 螺丝垫片, 作为螺丝之垫片。

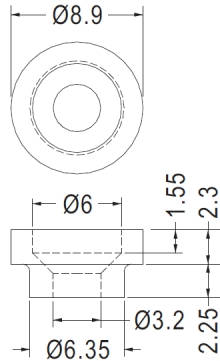

PART NO	PACKAGE
COCS-04	1000



- ◆ MATERIAL : NYLON 6 (UL)
- ◆ FLAME CLASS : 94HB
- ◆ COLOR : NATURAL
- ◆ UNIT: mm

用途: 螺丝垫片, 可配合螺丝使用之垫片。

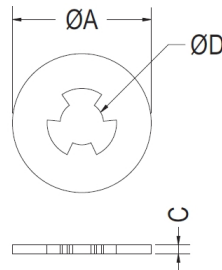

PART NO	A	C	D	PACKAGE
LKWS-1	4.8	0.5	2.2	2000
LKWS-2	4.8	0.8	2.2	2000
LKWS-3	4.8	1.0	2.2	2000
LKWS-4	8.0	0.5	2.5	2000

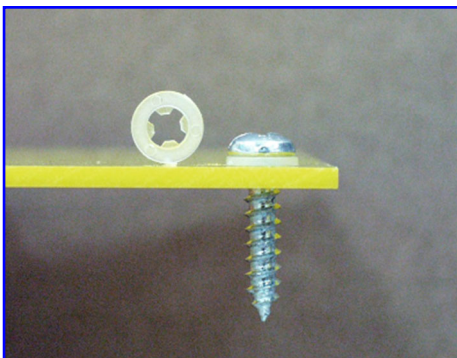

- ◆ MATERIAL : NYLON 66 (UL)
- ◆ FLAME CLASS : 94V-0/94V-2
- ◆ COLOR : NATURAL/BLACK
- ◆ UNIT: mm

用途: 螺丝垫片, 可配合螺丝使用, 垫片不脱落。

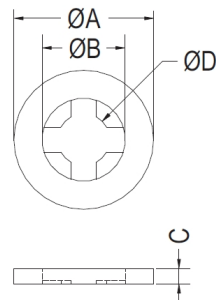

RECOMMENDED MATING SCREW: S

PART NO	A	B	C	D	S	PACKAGE
LKWS-5	5.0	4.0	0.6	2.5	M3	2000
LKWS-6	6.7	4.0	0.8	2.5	M3	2000
LKWS-7	6.7	3.5	1.2	2.5	M3	2000
LKWS-8	8.0	5.0	1.0	3.3	M4	2000
LKWS-9	15.0	9.5	0.9	4.6	M4	2000
LKWS-10	15.0	9.5	0.9	5.0	M5	2000
LKWS-11	15.0	9.5	0.9	5.8	M6	2000
LKWS-12	8.3	5.0	0.8	3.2	6-32 UNC	2000
LKWS-24	8.35	4.96	1.64	3.15	6-32 UNC	2000

螺丝垫片 CUP WASHER 垫圈 垫片 华司

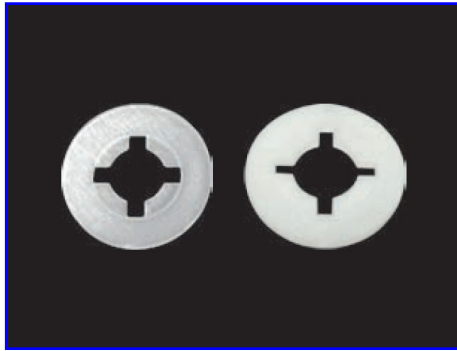

- ◆ MATERIAL : NYLON 66 (UL)
- ◆ FLAME CLASS : 94V-0/94V-2
- ◆ COLOR : NATURAL/BLACK
- ◆ UNIT: mm

用途：螺丝垫片，可配合螺丝使用，垫片不脱落。

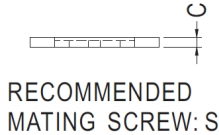
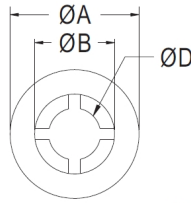

RECOMMENDED MATING SCREW: S

PART NO	A	B	C	D	S	PACKAGE
LKWS-13	11.45	7.1	0.85	4.6	M5	2000
LKWS-25	9.92	5.97	0.81	3.86	M4	2000
LKWS-43	8.5	5.8	0.9	4.4	M5	2000
LKWS-49	9.91	5.97	0.81	3.43	8-32 NUC	2000
LKWS-50	16.0	7.03	1.6	4.5	M5	2000

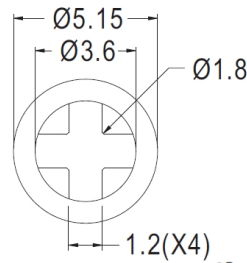

RECOMMENDED MATING SCREW: M2

PART NO	PACKAGE
LKWS-34	2000

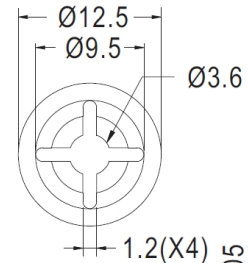

RECOMMENDED MATING SCREW: M4

PART NO	PACKAGE
LKWS-23	2000

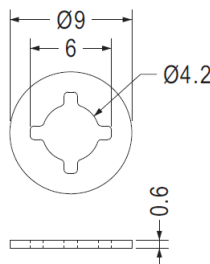
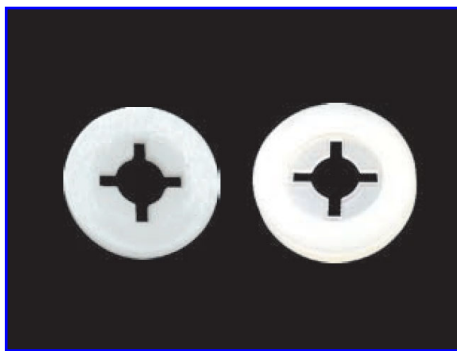

RECOMMENDED MATING SCREW: M5

PART NO	PACKAGE
LKWS-53	2000

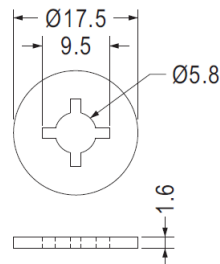

RECOMMENDED MATING SCREW: M5

PART NO	PACKAGE
LKWS-26	2000

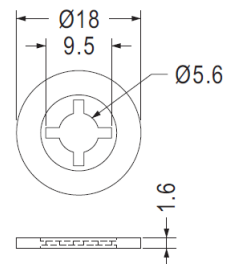

RECOMMENDED MATING SCREW: M5

PART NO	PACKAGE
LKWS-27	2000

螺丝垫片 CUP WASHER 垫圈 垫片 华司



- ◆ MATERIAL : NYLON 66 (UL)
- ◆ FLAME CLASS : 94V-0/94V-2
- ◆ COLOR : NATURAL/BLACK
- ◆ UNIT: mm

用途: 螺丝垫片, 可配合螺丝使用之垫片。

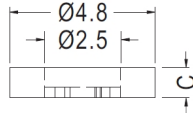
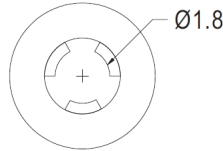

RECOMMENDED MATING SCREW: M2

PART NO	C	PACKAGE
LKWS-14	0.5	2000
LKWS-15	0.8	2000
LKWS-16	1.0	2000
LKWS-17	1.5	2000
LKWS-18	2.0	2000
LKWS-19	2.5	2000



- ◆ MATERIAL : NYLON 6 (UL)/PE/LDPE 用途: 螺丝垫片, 可配合螺丝使用之垫片。
- ◆ FLAME CLASS : 94V-2/94V-0
- ◆ COLOR : NATURAL/BLACK/BULE
- ◆ UNIT: mm

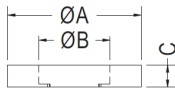
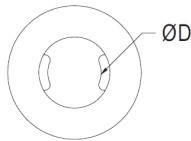

RECOMMENDED MATING SCREW: S

PART NO	A	B	C	D	S	PACKAGE
LKWS-20	6.0	3.2	1.0	2.4	M3	2000
LKWS-21	5.0	2.7	1.0	2.0	M2.6	2000
LKWS-22	18.0	10.5	1.5	8.7	M9	1000
LKWS-31	5.0	2.7	1.0	2.2	M2.6	2000
LKWS-32	5.0	2.7	1.5	2.2	M2.6	2000
LKWS-36	6.5	2.7	1.1	2.2	M2.6	2000



- ◆ MATERIAL : NYLON 66 (UL)/ NYLON 6 (UL)
- ◆ FLAME CLASS : 94V-0/94V-2
- ◆ COLOR : BLACK
- ◆ UNIT: mm

用途: 螺丝垫片, 可配合螺丝使用之垫片。

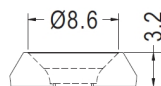
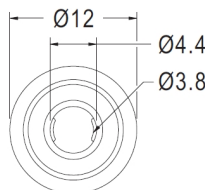

RECOMMENDED MATING SCREW: M4

PART NO	PACKAGE
LKWS-28	1000

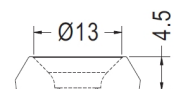
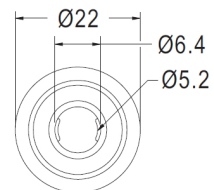

RECOMMENDED MATING SCREW: M6

PART NO	PACKAGE
LKWS-35	500

螺丝垫片 CUP WASHER 垫圈 垫片 华司

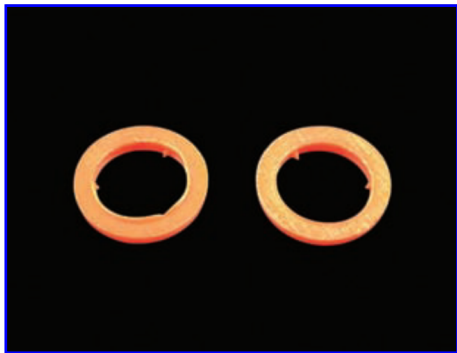

- ◆ MATERIAL : NYLON 66 (UL)
- ◆ FLAME CLASS : 94V-0/94V-2
- ◆ COLOR : NATURAL/BLACK/ORANGE
- ◆ UNIT: mm

用途： 螺丝垫片，可配合M3螺丝使用之垫片。

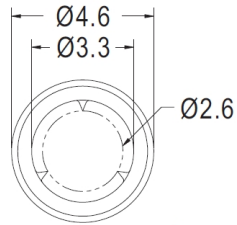

MATING SCREW: M3

PART NO	PACKAGE
LKWS-29	1000



- ◆ MATERIAL : NYLON 66 (UL)
- ◆ FLAME CLASS : 94V-2/94V-0
- ◆ COLOR : NATURAL/BLACK
- ◆ UNIT: mm

用途： 螺丝垫片，可配合M3.5螺丝使用之垫片。

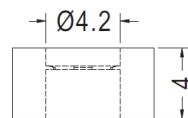
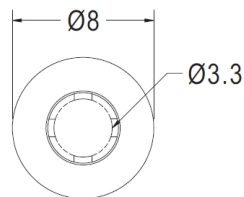

PART NO	PACKAGE
LKWS-30	1000

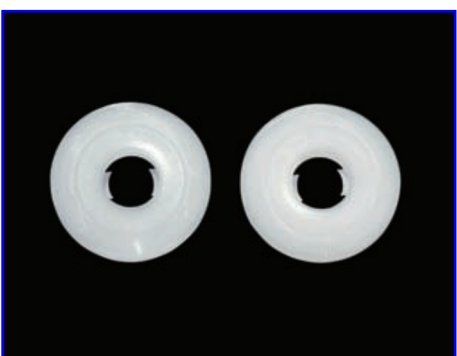

- ◆ MATERIAL : NYLON 66 (UL)
- ◆ FLAME CLASS : 94V-2/94V-0
- ◆ COLOR : NATURAL/BLACK
- ◆ UNIT: mm

用途： 螺丝垫片，可配合螺丝使用之垫片。

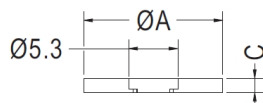
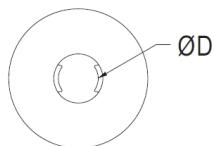

RECOMMENDED MATING SCREW: M5

PART NO	A	C	D	PACKAGE
LKWS-33	15.0	1.5	4.3	2000
LKWS-41	10.0	1.0	4.1	2000

螺丝垫片 CUP WASHER 垫圈 垫片 华司



- ◆ MATERIAL : NYLON 66 (UL)/PE
- ◆ FLAME CLASS : 94V-0/94V-2
- ◆ COLOR : NATURAL/BLACK
- ◆ UNIT: mm

用途: 螺丝垫片, 可配合螺丝使用之垫片。

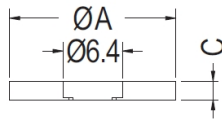
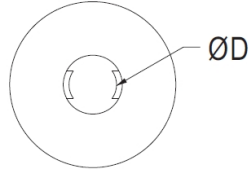

PART NO	A	C	D	PACKAGE
LKWS-42	18.0	2.0	5.15	2000
LKWS-45	12.0	1.6	5.0	2000

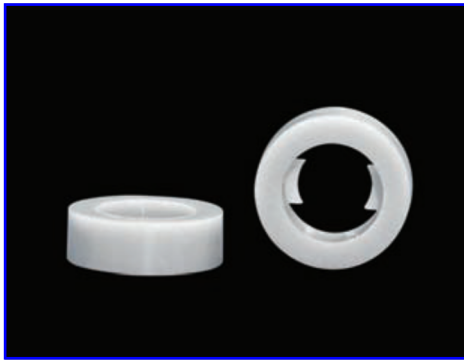

- ◆ MATERIAL : NYLON 6 (UL)/ NYLON 66(UL)/PE
- ◆ FLAME CLASS : 94V-2/94V-0/94HB
- ◆ COLOR : NATURAL/BLACK/GRAY
- ◆ UNIT: mm

用途: 螺丝垫片, 可配合螺丝使用之垫片。

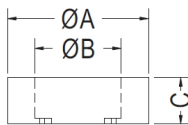
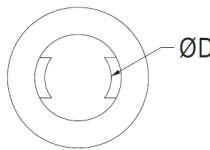

RECOMMENDED MATING SCREW: S

PART NO	A	B	C	D	S	PACKAGE
LKWS-39	12.0	4.3	1.4	3.3	M4	1000
LKWS-40	7.0	4.3	2.3	3.3	M4	1000
LKWS-44	9.0	3.2	1.5	2.6	M3	1000
LKWS-54	21.0	10.5	2.5	8.9	M10	1000

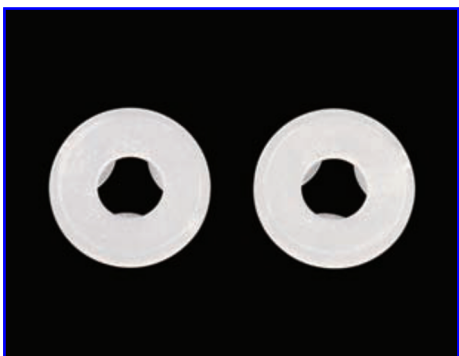

- ◆ MATERIAL : PE
- ◆ COLOR : NATURAL
- ◆ UNIT: mm

用途: 螺丝垫片, 可配合螺丝使用之垫片。

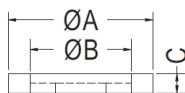
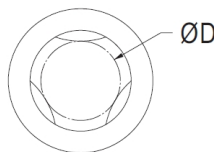

RECOMMENDED MATING SCREW: S

PART NO	A	B	C	D	S	PACKAGE
LKWS-37	12.0	8.4	1.6	6.6	M8	2000
LKWS-46	20.0	5.3	1.0	4.2	M5	2000
LKWS-47	12.0	6.4	1.6	5.2	M6	2000
LKWS-48	27.0	12.8	2.5	10.4	M12	500
LKWS-52	8.0	3.2	0.8	2.5	M3	2000

螺丝垫片 CUP WASHER 垫圈 垫片 华司



- ◆ MATERIAL : PP (UL)
- ◆ FLAME CLASS : 94HB
- ◆ COLOR : BLACK
- ◆ UNIT: mm

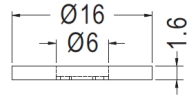
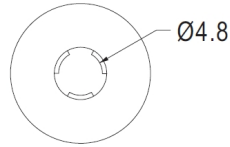

RECOMMENDED
MATING SCREW: M6

用途：螺丝垫片，可配合螺丝使用之垫片。

PART NO	PACKAGE
LKWS-38	2000

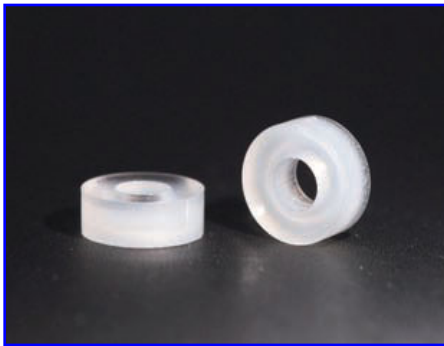

- ◆ MATERIAL : NYLON 66 (UL)
- ◆ FLAME CLASS : 94V-2/94V-0
- ◆ COLOR : NATURAL/BLACK
- ◆ UNIT: mm

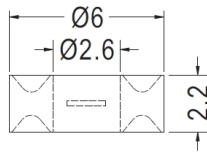
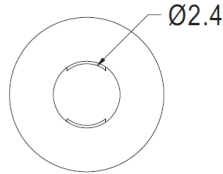

用途：螺丝垫片，可配合螺丝使用之垫片。

PART NO	PACKAGE
LKWS-51	2000

滚轮 CUP WASHER 垫圈 垫片 华司



用途：滚轮，用于机柜当滚轮使用。

- ◆ MATERIAL : PC(UL)
- ◆ FLAME CLASS : 94V-0/94V-2
- ◆ COLOR : BLACK
- ◆ UNIT: mm

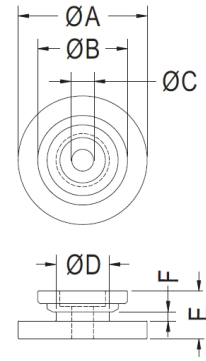

PART NO	A	B	C	D	E	F	PACKAGE
RDSC-09	25.4	17.67	4.3	11.07	9.36	1.79	1000
RDSC-31	25.4	17.7	4.3	11.0	9.4	1.95	1000

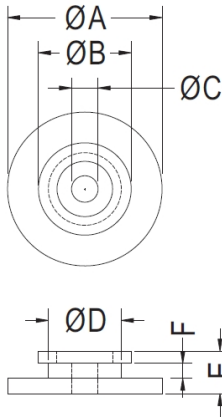

- ◆ MATERIAL : PTB(UL)
- ◆ FLAME CLASS : 94V-0/94V-2
- ◆ COLOR : BLACK
- ◆ UNIT: mm

PART NO	A	B	C	D	E	F	PACKAGE
RDSC-25	25.0	15.0	4.3	11.8	6.9	2.4	1000

- ◆ MATERIAL : POM
- ◆ FLAME CLASS : 94V-0/94V-2
- ◆ COLOR : BLACK
- ◆ UNIT: mm

PART NO	A	B	C	D	E	F	PACKAGE
RDSC-32	24.2	14.7	4.1	11.4	6.6	2.4	1000

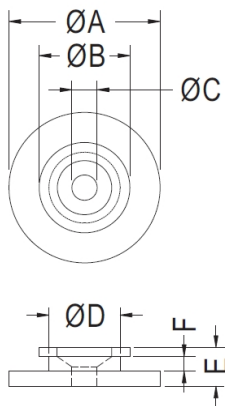

- ◆ MATERIAL : NYLON 66(UL)
- ◆ FLAME CLASS : 94V-0/94V-2
- ◆ COLOR : BLACK
- ◆ UNIT: mm

PART NO	A	B	C	D	E	F	PACKAGE
RDSC-23	25.0	15.0	4.2	11.8	6.45	2.45	1000

PC板垫片 PCB WASHER 垫圈 垫片 华司

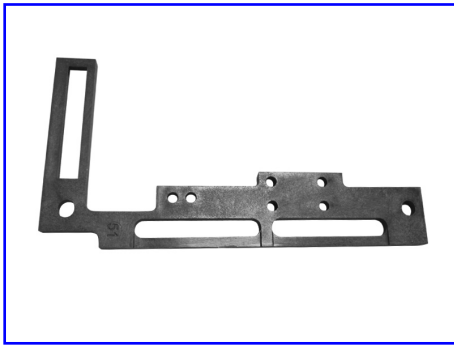

- ◆ MATERIAL : NYLON 46 (UL)
- ◆ FLAME CLASS : 94V-0
- ◆ COLOR : NATURAL/BLACK
- ◆ UNIT: mm

用途：PC板垫片，用于零件之垫片。

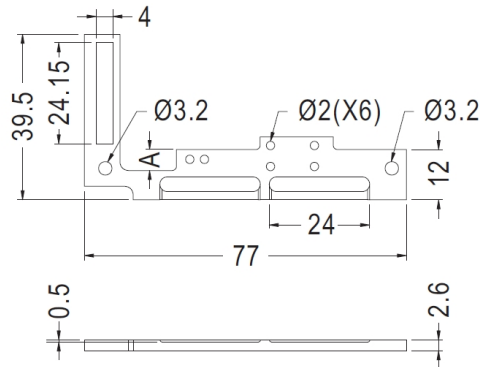

PART NO	A	PACKAGE
PCM-1	5.0	500
PCM-2	5.5	500



- ◆ MATERIAL : NYLON 6T (UL)
- ◆ FLAME CLASS : 94V-0
- ◆ COLOR : NATURAL/BLACK
- ◆ UNIT: mm

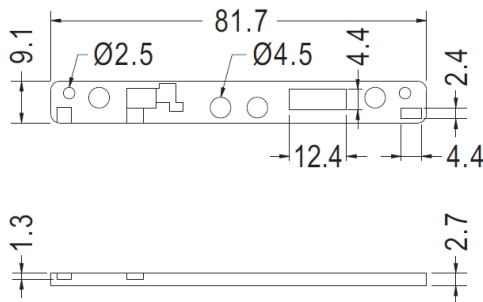

PART NO	PACKAGE
PCM-3	500

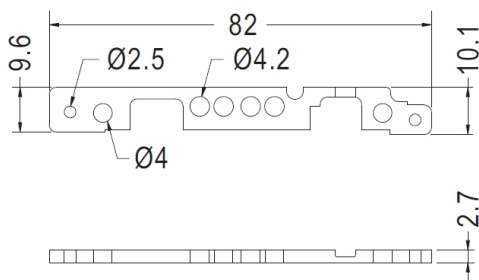

PART NO	PACKAGE
PCM-4	500

PC板垫片 PCB WASHER 垫圈 垫片 华司

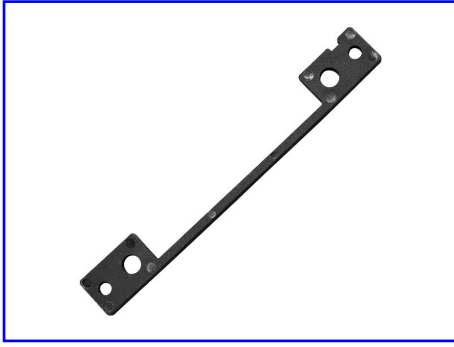

- ◆ MATERIAL : NYLON 6T (UL)
- ◆ FLAME CLASS : 94V-0
- ◆ COLOR : NATURAL/BLACK/WHITE
- ◆ UNIT: mm

用途：PC板垫片，用于零件之垫片。

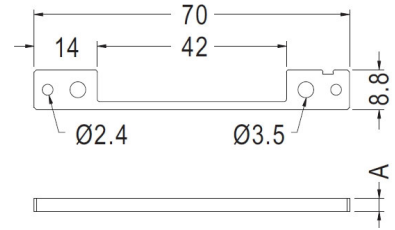
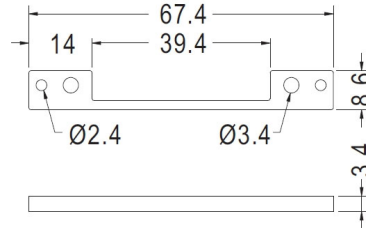

PART NO	PACKAGE
PCM-9	500

PART NO	A	PACKAGE
PCM-10	2.9	500
PCM-11	3.4	500

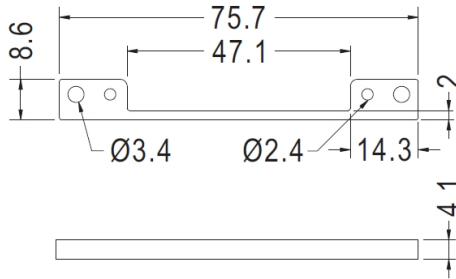

PART NO	PACKAGE
PCM-14	500

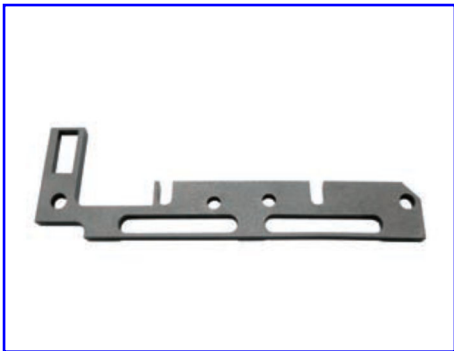

- ◆ MATERIAL : NYLON 46 (UL)
- ◆ FLAME CLASS : 94V-0
- ◆ COLOR : NATURAL/BLACK
- ◆ UNIT: mm

用途：PC板垫片，用于零件之垫片。

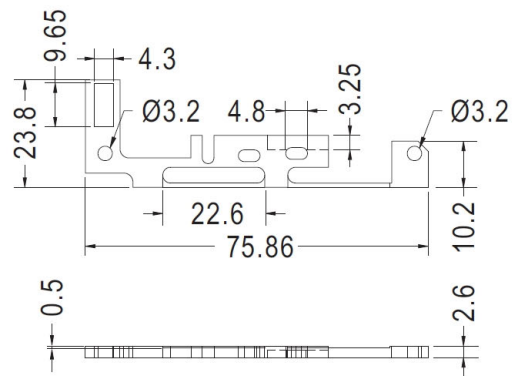
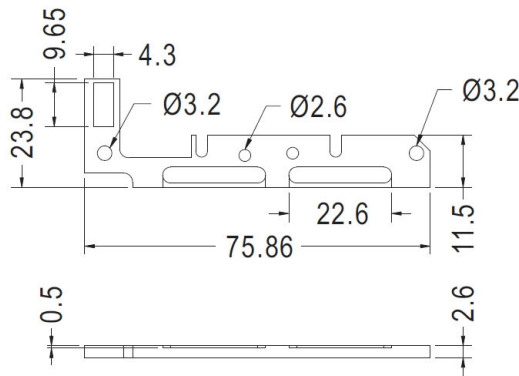

PART NO	PACKAGE
PCM-6	200

PART NO	PACKAGE
PCM-7	200

PC板垫片 PCB WASHER 垫圈 垫片 华司



- ◆ MATERIAL : NYLON 46 (UL)
- ◆ FLAME CLASS : 94V-0
- ◆ COLOR : NATURAL/BLACK
- ◆ UNIT: mm

用途：PC板垫片，用于零件之垫片。

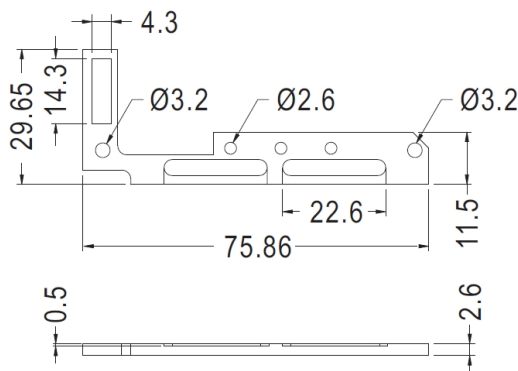

PART NO	PACKAGE
PCM-8	200

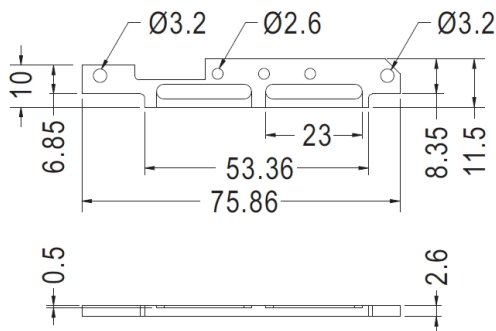

PART NO	PACKAGE
PCM-5	500

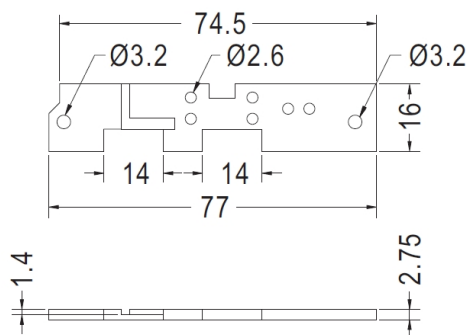

PART NO	PACKAGE
PCM-12	500

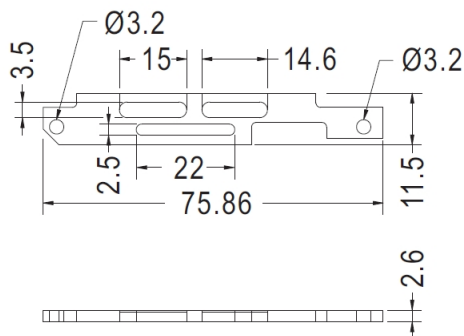
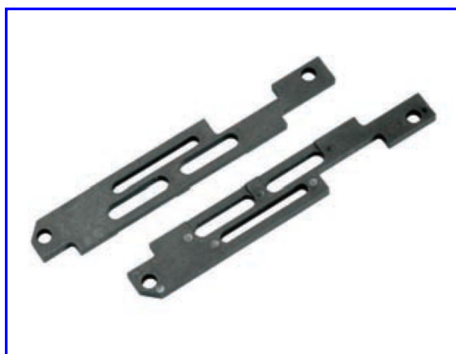

PART NO	PACKAGE
PCM-13	500

球击缓冲垫片 IMPACT BUFFER PAD 垫圈 垫片 华司



- ◆ MATERIAL : NYLON 66 (UL)
- ◆ FLAME CLASS : 94V-0/94V-2
- ◆ COLOR : BLACK
- ◆ UNIT: mm

用途：球击缓冲垫片，做为球击测试之缓冲垫片。

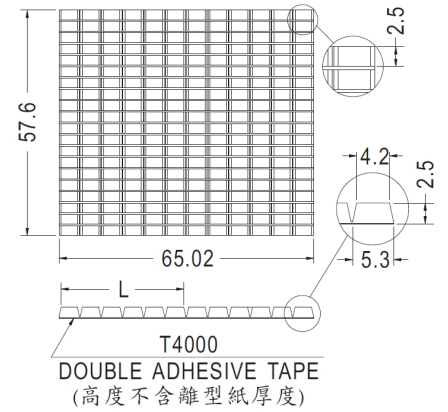
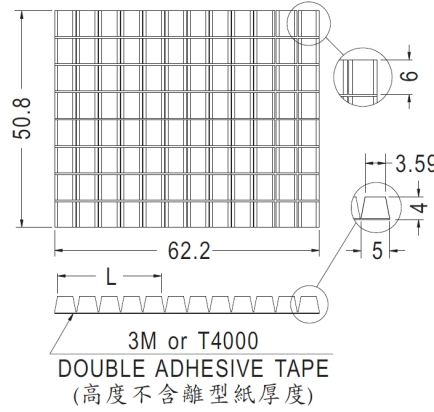
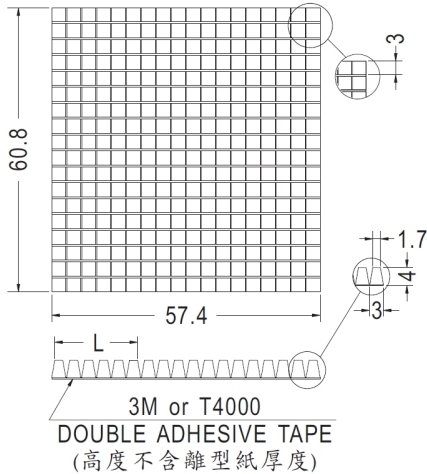

PART NO	A	PACKAGE
EMT-20	1.7	324 PCS
EMT-26	4.9	324 PCS
EMT-27	8.1	324 PCS
EMT-28	11.3	324 PCS
EMT-29	14.5	324 PCS
EMT-30	17.7	324 PCS

PART NO	A	PACKAGE
EMT-1	3.59	96 PCS
EMT-21	8.79	96 PCS
EMT-22	13.99	96 PCS
EMT-23	19.19	96 PCS
EMT-24	24.39	96 PCS
EMT-25	29.59	96 PCS

PART NO	A	PACKAGE
EMT-2	4.2	240 PCS
EMT-3	9.65	240 PCS
EMT-4	15.1	240 PCS
EMT-5	20.5	240 PCS
EMT-6	25.95	240 PCS
EMT-7	31.4	240 PCS

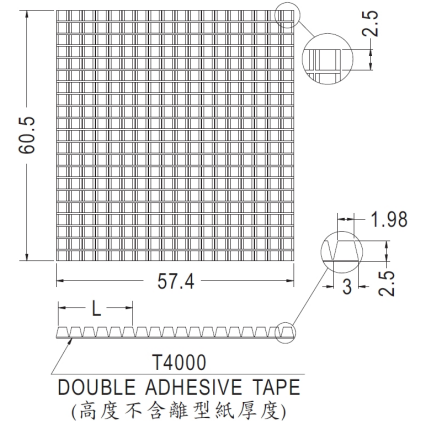
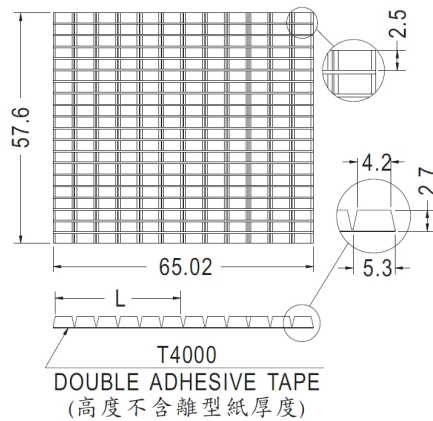

PART NO	A	PACKAGE
EMT-8	4.2	240 PCS
EMT-9	9.65	240 PCS
EMT-10	15.1	240 PCS
EMT-11	20.5	240 PCS
EMT-12	25.95	240 PCS
EMT-13	31.4	240 PCS

PART NO	A	PACKAGE
EMT-14	1.98	378 PCS
EMT-15	5.18	378 PCS
EMT-16	8.38	378 PCS
EMT-17	11.58	378 PCS
EMT-18	14.78	378 PCS
EMT-19	17.98	378 PCS

尼龙垫圈 WASHER 垫圈 垫片 华司 尼龙弹簧垫片



- MATERIAL : NYLON 46 (UL)/
 ◆ NYLON 6(UL)/PE/PBT(UL)/PP(UL)/
 POM(UL)
 ◆ COLOR : NATURAL/BLACK
 ◆ UNIT: mm

用途：尼龙垫圈，用于零件之垫片。

可依客户需求订製不同材質。
 Different materials available per request.

PART NO	A	B	C
WSS-1	3.7	2.2	1.0
WSS-2	5.0	3.2	0.5
WSS-13	5.6	3.73	0.3
WSS-14	4.0	2.5	0.5
WSS-15	4.5	2.5	0.5
WSS-16	6.0	2.5	0.5
WSS-24	4.5	2.1	0.8
WSS-36	6.0	3.1	1.5
WSS-42	4.5	2.0	0.8
WSS-43	5.0	2.1	2.0
WSS-47	4.0	2.6	2.0
WSS-48	5.5	2.3	0.5
WSS-49	4.5	2.1	0.9
WSS-50	4.5	2.1	1.2
WSS-51	5.0	2.1	1.0
WSS-53	6.0	2.7	3.0
WSS-54	4.1	3.1	1.2
WSS-55	5.0	3.0	2.5
WSS-60	5.0	3.1	1.0
WSS-83	5.6	3.1	1.5
WSS-92	5.0	2.5	1.1
WSS-100	3.7	2.2	1.2
WSS-101	5.0	2.5	1.3
WSS-107	4.2	1.9	0.5
WSS-111	6.0	2.3	0.8
WSS-220	14.2	6.35	1.5
WSS-221	22.0	13.0	5.0

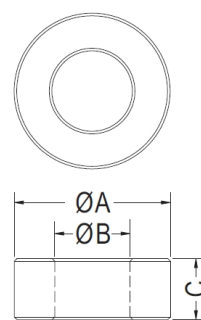
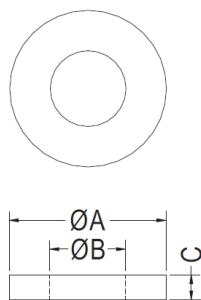

WSS-124
 WSS-125

PART NO	A	B	C
WSS-114	6.0	3.1	0.5
WSS-124	6.0	2.9	2.35
WSS-125	6.0	3.6	1.4
WSS-128	5.5	3.2	2.8
WSS-133	4.5	2.9	1.2
WSS-140	4.5	2.1	1.1
WSS-141	4.5	2.1	1.7
WSS-143	6.0	3.0	0.8
WSS-145	4.9	3.7	1.5
WSS-146	5.0	3.1	1.8
WSS-147	4.5	2.1	1.1
WSS-148	4.5	2.1	1.3
WSS-149	4.0	3.1	1.0
WSS-150	3.5	1.7	0.5
WSS-154	7.5	4.7	0.8
WSS-163	3.5	1.8	1.0
WSS-193	4.5	2.1	1.8
WSS-204	5.0	3.1	2.0
WSS-3	6.35	2.3	2.5
WSS-4	6.35	3.05	1.27
WSS-17	6.5	3.8	0.5
WSS-18	7.0	2.2	0.5
WSS-19	7.1	3.7	0.5
WSS-20	7.5	3.5	0.5
WSS-27	6.8	4.2	1.0
WSS-28	7.0	3.0	1.0

尼龙垫圈 WASHER 垫圈 垫片 华司 尼龙弹簧垫片

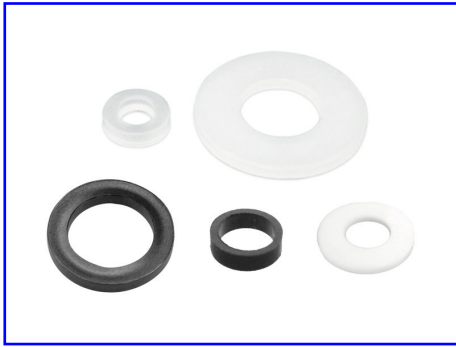

- MATERIAL : NYLON 46 (UL)/
 ◆ NYLON 6(UL)/PE/PBT(UL)/PP(UL)/
 POM(UL)
 ◆ COLOR : NATURAL/BLACK
 ◆ UNIT: mm

用途：尼龙垫圈，用于零件之垫片。

可依客户需求订製不同材質。
 Different materials available per request.

PART NO	A	B	C
WSS-41	6.5	4.0	1.65
WSS-44	6.0	3.1	2.0
WSS-52	6.5	4.0	2.5
WSS-56	7.0	3.0	0.8
WSS-61	6.5	3.1	2.0
WSS-64	7.0	3.3	2.0
WSS-65	6.0	3.1	3.4
WSS-66	7.0	3.6	3.2
WSS-70	6.0	3.8	1.0
WSS-75	7.0	5.0	1.6
WSS-116	6.0	3.8	1.5
WSS-117	6.3	4.2	1.55
WSS-121	7.5	4.3	0.65
WSS-34	6.1	3.7	1.2
WSS-126	6.5	3.25	0.9
WSS-134	6.0	4.5	1.0
WSS-136	6.35	3.18	1.58
WSS-137	7.11	3.05	1.57
WSS-138	7.13	5.53	1.58
WSS-139	6.5	4.0	2.2
WSS-142	7.0	3.1	0.5
WSS-144	6.0	3.2	1.4
WSS-151	6.0	4.0	0.6
WSS-152	6.0	3.2	0.5
WSS-153	7.0	4.3	2.3

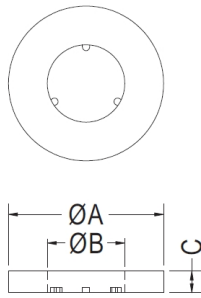
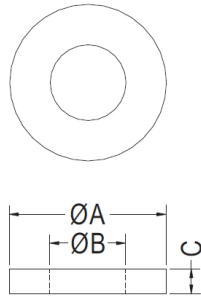

WSS-126

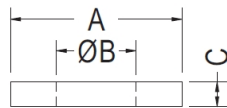
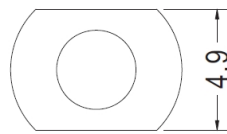

WSS-208

PART NO	A	B	C
WSS-194	6.0	4.0	0.6
WSS-195	7.0	3.2	0.5
WSS-196	7.0	4.3	2.0
WSS-197	7.4	4.5	0.5
WSS-208	6.9	3.2	1.0
WSS-21	8.0	5.2	0.5
WSS-22	9.0	4.5	0.5
WSS-29	9.0	2.5	1.0
WSS-37	8.8	2.0	1.5
WSS-57	8.0	4.6	0.3
WSS-67	8.0	3.6	2.5
WSS-68	8.0	3.6	0.8
WSS-71	8.0	4.0	2.0
WSS-73	8.65	4.1	1.0
WSS-74	10.0	4.3	4.0
WSS-76	8.0	3.1	0.5
WSS-77	8.0	4.1	0.5
WSS-78	8.0	5.0	1.0
WSS-79	8.0	5.0	5.0
WSS-84	8.0	5.1	2.0
WSS-89	9.0	6.7	2.0
WSS-90	8.0	3.1	0.8
WSS-91	8.0	4.1	0.8
WSS-93	8.0	3.1	1.0
WSS-94	8.0	4.1	1.0

尼龙垫圈 WASHER 垫圈 垫片 华司 尼龙弹簧垫片



- MATERIAL : NYLON 46 (UL)/
 ◆ NYLON 6(UL)/PE/PBT(UL)/PP(UL)/
 POM(UL)
 ◆ COLOR : NATURAL/BLACK
 ◆ UNIT: mm

用途：尼龙垫圈，用于零件之垫片。

可依客户需求订製不同材質。
 Different materials available per request.

PART NO	A	B	C
WSS-96	10.0	3.1	1.0
WSS-103	8.0	3.1	1.5
WSS-104	8.0	4.1	1.5
WSS-108	8.0	3.1	2.0
WSS-109	8.0	4.1	2.0
WSS-118	9.6	4.4	0.8
WSS-122	8.0	5.5	1.8
WSS-129	7.1	3.7	0.5
WSS-131	8.0	5.5	1.5
WSS-155	8.0	2.0	2.0
WSS-164	8.0	5.5	0.75
WSS-165	9.0	5.5	0.75
WSS-166	10.0	5.1	2.4
WSS-173	8.0	4.2	2.85
WSS-176	8.3	5.65	1.0
WSS-177	8.3	6.1	1.0
WSS-185	10.0	4.5	1.5
WSS-198	9.0	3.2	0.5
WSS-199	9.0	4.3	1.0
WSS-203	7.7	5.3	0.7
WSS-205	8.0	5.2	0.5
WSS-5	10.0	6.4	2.8
WSS-6	11.0	5.2	1.5
WSS-7	11.0	7.0	0.8
WSS-8	12.7	6.48	1.52
WSS-9	12.7	6.48	2.0
WSS-10	12.7	6.5	6.5
WSS-11	12.7	7.9	1.57
WSS-25	12.8	6.4	0.8
WSS-30	10.0	5.2	1.0
WSS-45	10.0	5.2	2.0
WSS-80	11.3	5.4	1.3

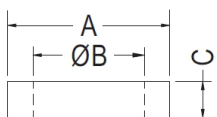
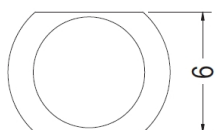
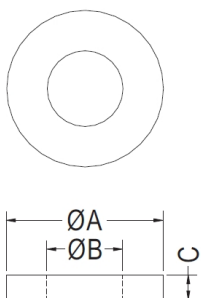

WSS-122

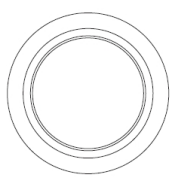

WSS-129

PART NO	A	B	C
WSS-81	12.0	5.0	2.0
WSS-85	10.0	5.2	0.8
WSS-98	14.7	11.5	1.0
WSS-115	11.5	3.5	4.0
WSS-120	14.0	8.0	1.2
WSS-132	10.0	6.4	0.8
WSS-156	11.6	3.2	1.0
WSS-157	11.6	7.6	1.0
WSS-158	12.0	5.2	0.8
WSS-159	15.0	4.3	1.5
WSS-167	10.0	5.7	2.0
WSS-168	10.2	5.2	1.5
WSS-169	12.8	6.4	2.0
WSS-170	14.0	8.0	2.0
WSS-174	10.0	5.7	1.0
WSS-175	10.0	8.0	1.6
WSS-178	10.0	5.5	0.8
WSS-179	10.0	6.1	1.6
WSS-183	11.0	7.2	2.5
WSS-186	12.0	6.4	1.4
WSS-187	11.0	7.2	1.2
WSS-188	11.3	7.6	0.5
WSS-189	12.0	4.3	1.0
WSS-200	12.0	5.3	2.0
WSS-201	13.4	12.5	1.0
WSS-211	10.15	6.35	1.6
WSS-212	12.8	6.48	3.0
WSS-213	13.0	8.1	1.6
WSS-214	14.0	8.1	0.8
WSS-216	10.9	4.4	0.8
WSS-23	21.8	19.1	0.5
WSS-26	16.0	10.0	0.8

尼龙垫圈 WASHER 垫圈 垫片 华司 尼龙弹簧垫片



- ◆ MATERIAL : NYLON 66 (UL)
- ◆ FLAME CLASS : 94V-0/94V-2
- ◆ COLOR : NATURAL/BLACK
- ◆ UNIT: mm

用途：尼龙垫圈，用于零件之垫片。

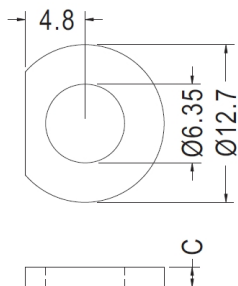

PART NO	C	PACKAGE
WSS-217	1.58	1000
WSS-218	6.35	1000

硅胶垫圈 Silicon Washer 垫圈 垫片 华司 尼龙弹簧垫片



- ◆ MATERIAL : SILICON RUBBER
- ◆ COLOR : BLUE
- ◆ UNIT: mm

用途：硅胶垫圈，用于零件之垫片。

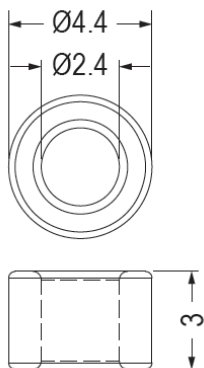

PART NO	PACKAGE
WSS-219	5000

垫圈 WASHER 垫圈 垫片 华司 尼龙弹簧垫片

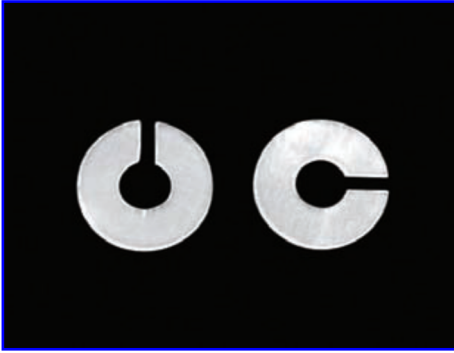

- ◆ MATERIAL : NYLON 66 (UL)/NYLON 用途: 垫圈, 用于零件之垫片。
UL6(UL)/PC (UL)
- ◆ FLAME CLASS : 94V-0/94V-2/94HB
- ◆ COLOR : NATURAL/BLACK
- ◆ UNIT: mm

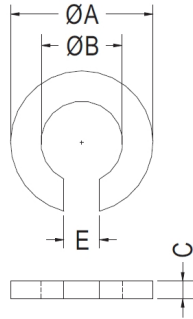

PART NO	A	B	C	E	PACKAGE
COCS-01	4.0	2.3	0.5	1.0	2000
COCS-02	6.0	3.0	1.0	1.0	2000
COCS-03	8.0	5.0	4.0	2.5	1000

- ◆ MATERIAL : NYLON 66 (UL)
- ◆ FLAME CLASS : 94V-0/94V-2
- ◆ COLOR : NATURAL/BLACK
- ◆ UNIT: mm

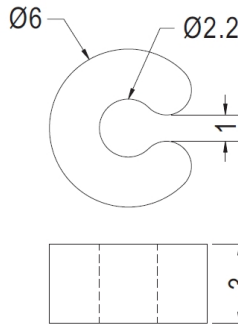

PART NO	PACKAGE
COCS-14	1000



- ◆ MATERIAL : ABS (UL)
- ◆ FLAME CLASS : 94HB
- ◆ COLOR : NATURAL
- ◆ UNIT: mm

用途: 垫圈, 可配合螺丝使用之垫片。

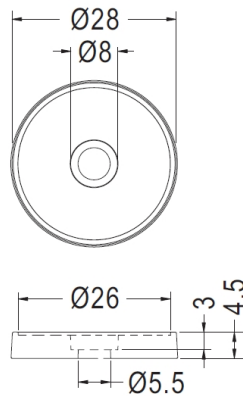

PART NO	PACKAGE
COCS-05	1000

垫圈 WASHER 垫圈 垫片 华司 尼龙弹簧垫片



- ◆ MATERIAL : NYLON 66 (UL)
- ◆ FLAME CLASS : 94V-0/94V-2
- ◆ COLOR : NATURAL/BLACK
- ◆ UNIT: mm

用途：垫圈，可配合螺丝使用之垫片。

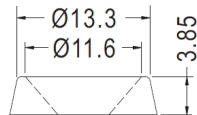
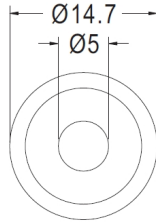

PART NO	PACKAGE
COCS-06	2000



用途：垫圈，可配合螺丝使用之垫片。

- ◆ MATERIAL : POM (UL)
- ◆ FLAME CLASS : 94HB
- ◆ COLOR : NATURAL/BLACK
- ◆ UNIT: mm

- ◆ MATERIAL : PE
- ◆ COLOR : BLACK / RED
- ◆ UNIT: mm

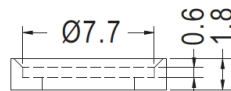
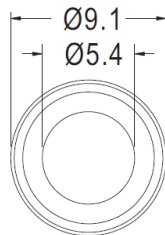

PART NO	PACKAGE
COCS-07	2000

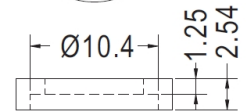
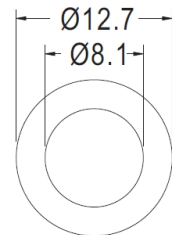

PART NO	PACKAGE
COCS-13	2000



- ◆ MATERIAL : NYLON 66 (UL)
- ◆ FLAME CLASS : 94V-0/94V-2
- ◆ COLOR : NATURAL/BLACK
- ◆ UNIT: mm

用途：垫圈，做为零件之垫片。

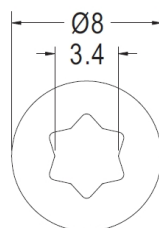

PART NO	PACKAGE
COCS-08	1000

垫圈 WASHER 垫圈 垫片 华司



- ◆ MATERIAL : NYLON 66 (UL)
- ◆ FLAME CLASS : 94V-0/94V-2
- ◆ COLOR : NATURAL/BLACK
- ◆ UNIT: mm

用途：垫圈，做为零件之垫片。

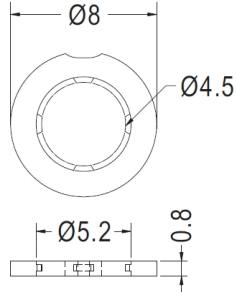

PART NO	PACKAGE
COCS-11	1000

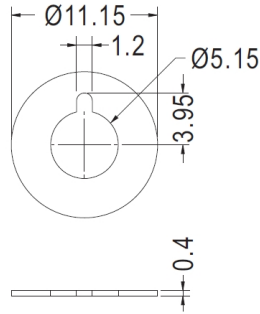

PART NO	PACKAGE
COCS-12	1000

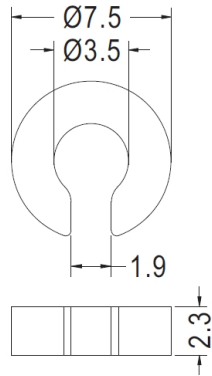

PART NO	PACKAGE
COCS-10	1000



- ◆ MATERIAL : POM
- ◆ COLOR : BLACK
- ◆ UNIT: mm

用途：垫圈，做为零件之垫片。

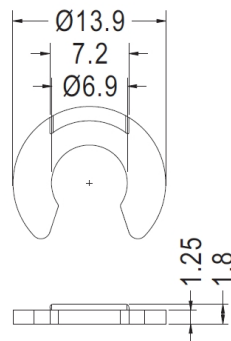

PART NO	PACKAGE
COCS-09	1000

垫圈 WASHER 垫圈 垫片 华司



- ◆ MATERIAL : NYLON 66 (UL)
- ◆ FLAME CLASS : 94V-0/94V-2
- ◆ COLOR : NATURAL/BLACK
- ◆ UNIT: mm

用途：垫圈，可配合螺丝使用之垫片。

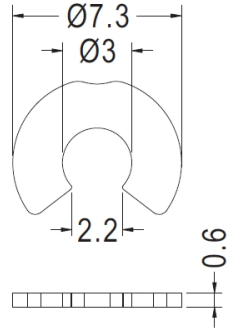

PART NO	PACKAGE
COCS-15	1000

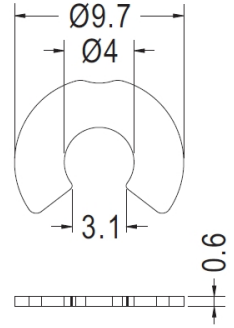

PART NO	PACKAGE
COCS-16	1000



- ◆ MATERIAL : POM
- ◆ COLOR : NATURAL
- ◆ UNIT: mm

用途：垫圈，作为零件之垫片。

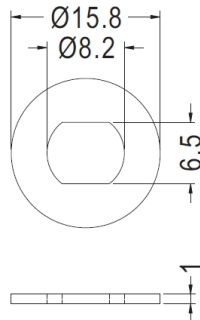

PART NO	PACKAGE
COCS-17	1000

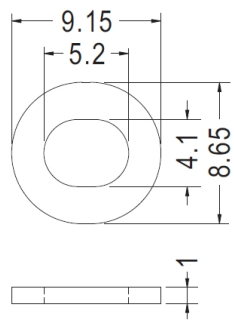

PART NO	PACKAGE
COCS-18	1000

垫片 WASHER 垫圈 华司

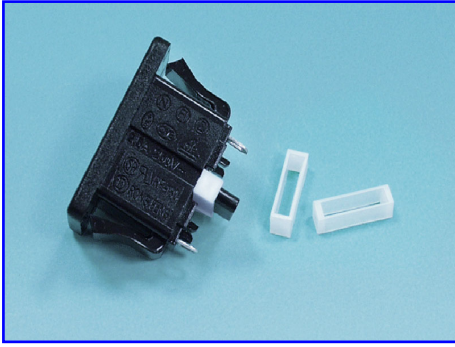

- ◆ MATERIAL : NYLON 66 (UL)
- ◆ FLAME CLASS : 94V-0/94V-2
- ◆ COLOR : NATURAL/BLACK
- ◆ UNIT: mm

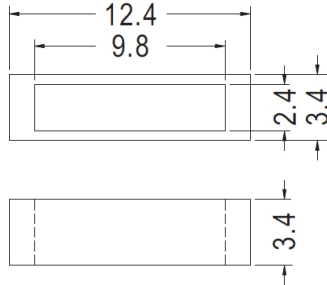

用途：垫片，用于电源插座接点间之绝缘。

PART NO	PACKAGE
DPW14	2000



- ◆ MATERIAL : NYLON 66 (UL)
- ◆ FLAME CLASS : 94V-0/94V-2
- ◆ COLOR : NATURAL/BLACK
- ◆ UNIT: mm

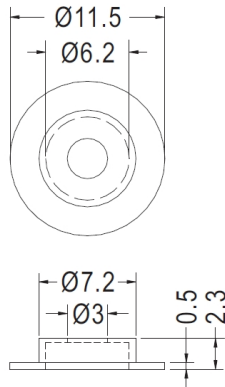

用途：垫片，螺丝垫片耐热性良好。

PART NO	PACKAGE
DPW18	2000

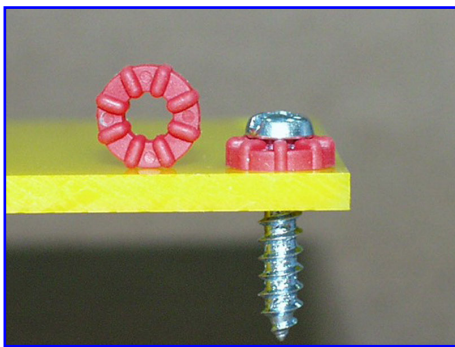

- ◆ MATERIAL : TPE
- ◆ COLOR : BLACK/RED
- ◆ UNIT: mm

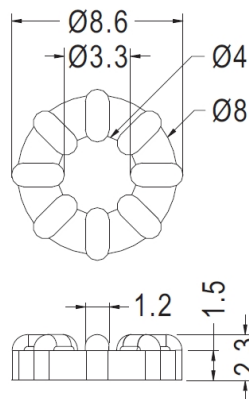

用途：风扇螺丝垫片抗震性良好。

PART NO	PACKAGE
DPW19	2000

垫片 WASHER 垫圈 华司



- ◆ MATERIAL : PC (UL)
- ◆ FLAME CLASS : 94V-0/94V-2
- ◆ COLOR : NATURAL/BLACK
- ◆ UNIT: mm

用途：零件之垫片。

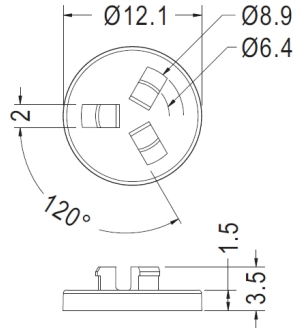

PART NO	PACKAGE
DPW21	2000



用途：垫片，作为零件之垫片。

- ◆ MATERIAL : PE
- ◆ COLOR : BLACK
- ◆ UNIT: mm

- ◆ MATERIAL : P66(UL)
- ◆ FLAME CLASS : 94V-0/94V-2
- ◆ COLOR : BLACK
- ◆ UNIT: mm

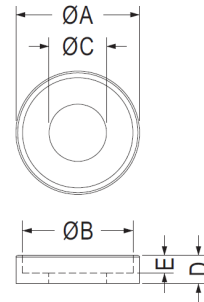
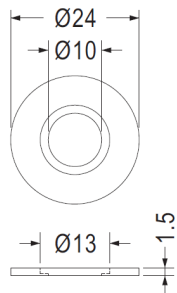

PART NO	PACKAGE
DPW15	1000

PART NO	A	B	C	D	E	PACKAGE
DPW27	14.0	12.5	6.5	3.2	2.0	1000
DPW28	12.45	9.8	4.45	3.55	2.3	2000

散热陶瓷垫片 CERAMIC HEAT SINK 垫圈 华司

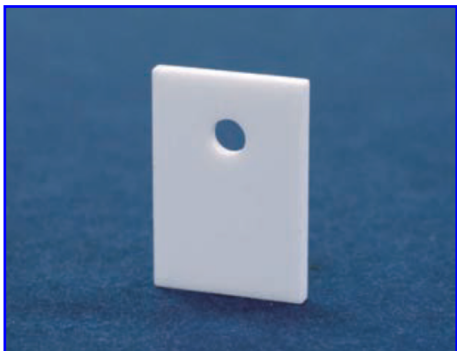

- ◆ MATERIAL : CERAMIC
- ◆ COLOR : WHITE
- ◆ UNIT: mm

用途：散热陶瓷垫片，用于零件之绝缘散热，散热性佳。

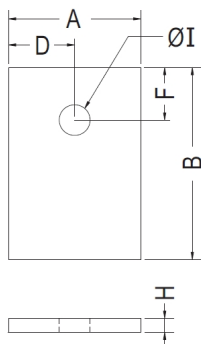

PART NO	A	B	D	F	H	I	PACKAGE
TO-3-NH	15.0	21.9	7.5	6.0	1.6	3.5	200
TO-220-NH	13.7	19.0	6.85	5.0	2.0	3.8	100

电子电脑塑胶五金零件目录

1.LED间隔柱

2.LED导光柱 LED导光盖 LED遮光罩

3.LED座 LED座套 红外线灯罩 光纤座

4.90°LED灯座 45°LED灯座

5. PC板间隔柱 PC板隔离柱

6. 塑料铜柱 尼龙柱 六角隔离柱 塑胶铜柱 铜柱 导光板隔离柱 圆体间隔柱 PC板固定定座 固定扣 电路板隔离柱 导电隔离柱

7. 排线固定座 自粘式配线固定座 排线固定夹 压线板 电线固定座 扭线固定座 扭式固定环 扎线固定座 电源线固定座 电源线固定座插头固定扣 天线固定座 T8灯管固定座 风扇束线座 光纤固定座

8. PC板端子 接线插片端子 PC板焊接端子 接地片 圆形连接片 弹片 测试针 探针 测试点 保险丝座 保险丝盖 插式电线连接头 闭端端子 弹簧螺纹端子 压线帽 端子台 快速接线夹 跳线

9. 仪表脚垫 插销式脚垫 螺丝固定脚垫 脚垫 抗震脚垫 磁铁脚垫 橡胶脚垫 自粘脚垫 银框脚垫 金框脚垫 橡胶垫圈 橡胶华司 橡胶垫片 硅胶脚垫

10. 塑料螺丝 塑胶螺丝 翼型塑料螺丝 塑料螺帽 塑料螺帽 蝶形螺母 止付螺丝 紧定螺钉 内牙螺丝 螺丝帽盖 手转螺丝 手拧螺丝 滚花螺丝 手转螺母 手拧螺母

11. PC板拉柄 PC板耳把 PC板导槽 电路板导轨 PCB导轨槽 直立式导槽 电路板导轨

12. 晶体管盖 电晶体盖 晶体管垫片 电晶体垫片 晶体管座 电晶体座 T-O3晶体管座 石英晶体垫片 垫圈 华司 垫片 TO-220晶体管座 光电晶体座 电晶体座 IR晶体座 霍尔晶体座 硅胶帽套 功率晶体导热硅片 功率晶体压板 电源固定压条 晶体管固定弹片 五金弹片 电晶体固定弹片 晶体管夹

电子电脑塑胶五金零件目录

13.电容器垫片 垫圈 华司 电容器座 电容器帽套 电容器固定座 电容器盖 电容器护套 压敏护套 硅胶帽套

14.热敏电阻座 电阻保护座 保护电阻器 可变电阻盖

15.陶瓷零件垫片 零件垫片 垫圈 华司 零件垫座 IC座 桥式整流座 跳线座 线圈座 滤波器垫片 绝缘柱 螺丝垫片 滚轮 PC板垫片 球击缓冲垫片 尼龙垫圈 尼龙弹簧垫片 散热陶瓷垫片

16.功率IC盖 桥式整流盖 保护盖 开关盖 硅胶盖 绝缘盖 电池盖 末端套管 软质端子保护套PC端子保护套 喇叭座 拉柄箱扣 线圈固定座 DRAM固定带 十字型插件式固定器 轨道固定器

17.孔塞 扣式孔塞 扣式塞头 DVI防尘盖 螺丝孔孔塞 螺丝塞头 螺纹孔塞

18.电源线扣 电线固定夹 护线环 橡胶圈 护线圈 开口式护线环 橡胶线环 硅胶线环 硅胶护线环 天线护线环 方型护线环 U型护线环 抗震护线环 防震线环 抗震线环用插销 抗震线环用螺丝 硬盘驱动器防震座 透气压力平衡固定头 透气平衡压力固定扣

19.把手 机箱把手 仪器门拉手 纸箱把手 纸箱配件 打包扣 外箱护脚垫 纸箱外箱扣

20.阻尼齿轮 阻尼器 缓冲齿轮

21.电线扎带 电线束线带 固定带 扎线 电源线收线带 珠型扎带 水管座 扎带座 扎带扣 吊勾粘扣带 绑线带

22.USB座护盖 USB端口保护盖 USB端口防尘盖 MICRO USB防尘盖 MINI USB座护盖USB Type-C防尘盖 USB防尘盖 RJ-45防尘盖 RJ-11防尘盖 RJ-12防尘盖 RJ-22防尘盖 电源插头防尘盖 电源插头保护座 电源插头防尘座 电源插头防尘盖 光纤连接器护盖 光纤连接器护套 光纤防尘盖 PC板金手指防尘盖 HDMI防尘盖 Mini数位端子防尘盖 汽车点烟器防尘盖BBU防尘盖 DVI防尘盖 连接器盖 SIM Card Cap防尘盖 SD防尘盖 KVM防尘盖 CF防尘盖 防尘盖 端子盖 S端子盖 平衡端子盖 BNC绝缘座 SATA防尘盖 ESATA护盖 DP端子防尘盖 Mini D.P数位端子防尘盖 D.Type防尘盖 VGA防尘盖 IDE Connector防尘盖 PC端子防尘盖 端子防尘盖 1394端子防尘盖 零件盖 电源盖 机板电源保护盖 连接器座 PCMIC卡保护盖 面板 DDR防尘盖 D-Sub保护盖 高压防尘盖 SD保护盖 Micoro SD卡保护盖 SIM卡保护盖 防水帽盖 帽盖连接带 防水圈 电脑风扇防护盖 电脑风扇防尘座 电脑风扇框护垫 电脑风扇支架 开关遮板 光纤晶体座

电子电脑塑胶五金零件目录

23.插销 铆钉 尼龙铆钉 螺丝铆钉 散热片铆钉 塑料铆钉 电脑风扇铆钉 散热片扣件 弹簧铆钉 螺丝固定座 膨胀螺栓 墙塞 无帽鱼型膨胀管 墙面固定座 石膏板固定座

24.固定扣 门扣开关 机器门扣开关 弹簧固定座 旋转型门扣 门扣碰珠 磁铁门扣

55.工具 线扣工具 进口束线枪 旗型端子工具 国产束线枪 非绝缘端子工具 绝缘端子工具



电子电脑塑胶五金零件目录



1.LED间隔柱



2.LED导光柱



3.LED座



4.90°LED灯座



5.PC板间隔柱



6.塑料铜柱



7.排线固定座



8.PC板端子



9.仪表脚垫



10.塑料螺丝



11.PC板拉柄导槽



12.晶体管盖

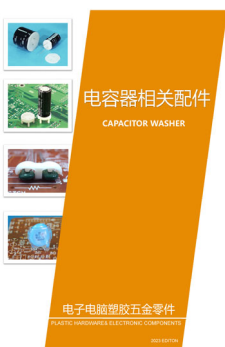

13.电容器垫片



14.热敏电阻座



15.陶瓷零件垫片



16.功率IC盖



电子电脑塑胶五金零件目录



17.孔塞



18.电源线扣



19.机箱把手



20.阻尼齿轮



21.电线扎带



22.USB座护盖



23.尼龙铆钉



24.门扣开关



55.工具

电子电脑塑胶五金零件

PLASTIC HARDWARE & ELECTRONIC COMPONENTS



南京诺金电气有限公司

Nanjing Nojin Electric Co., Ltd.

2023.03/17/24

选型手册总目录

本公司保留因质量改进、后续开发或生产要求引起的设计更改权力。本产品目录为元件的详细说明，不能做担保依据。使用者有义务审核该元件是否符合应用范围的规定。



微信



QQ

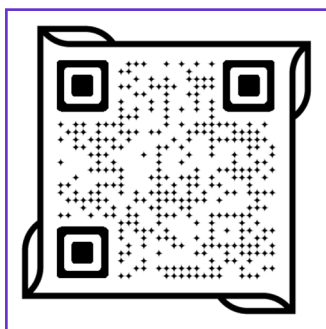

网站

南京诺金电气有限公司

Nanjing Nowking Electric Co., Ltd

- ◆ Tel: 025-85422485 85436028 85437901
- ◆ Wechat/Mobile :13770725488
- ◆ QQ:260678075
- ◆ E-mail: nk@nowking.com
- ◆ [Http://www.nowking.com](http://www.nowking.com)
- ◆ [Http://www.kyphe.com](http://www.kyphe.com)