

功率IC盖

POWER IC COVER

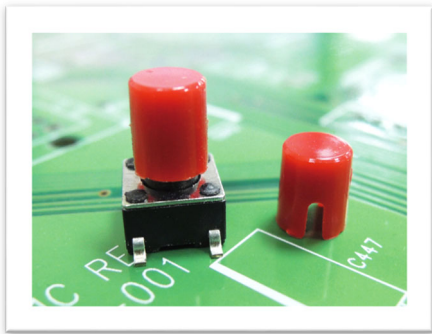

开关盖

TACT SWITCH CAP



软质端子保护套

TERMINAL SOFT SLEEVES

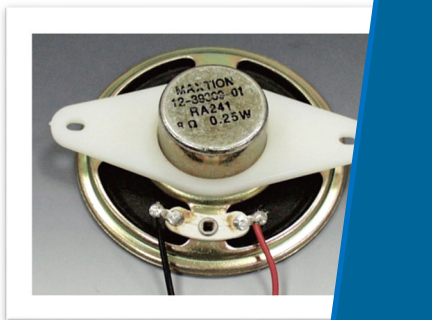

喇叭座

SPEAKER HOLDER

电子电脑塑胶五金零件

PLASTIC HARDWARE& ELECTRONIC COMPONENTS

2023 EDITON

功率IC盖 桥式整流盖 保护盖 开关盖 硅胶盖 绝缘盖 电池盖 末端套管 软质端子保护套 PC
端子保护套 喇叭座 喇叭箱扣 线圈固定座 DRAM固定带 十字型插件式固定器 轨道固定器

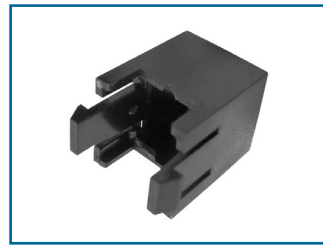
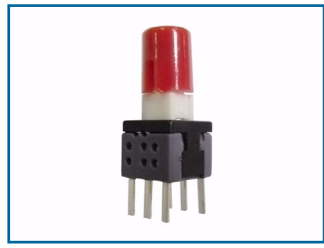
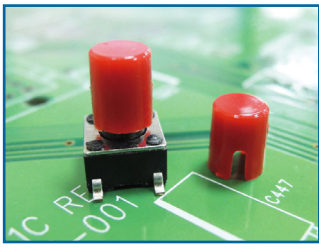
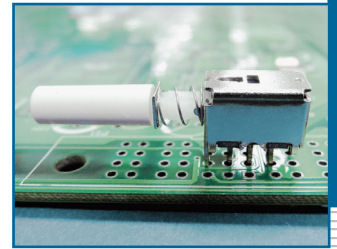
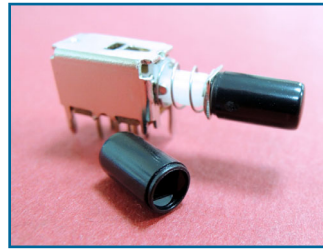
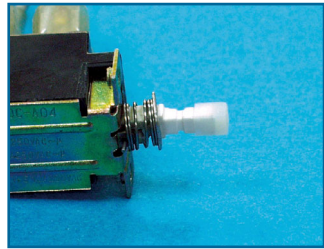
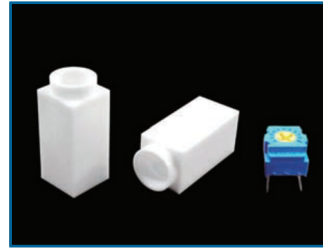
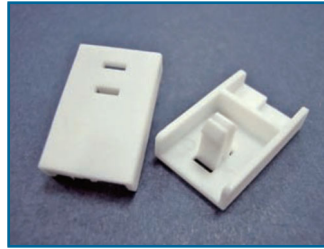
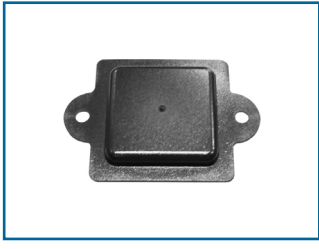
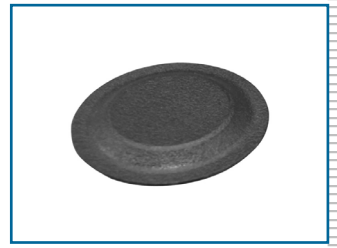
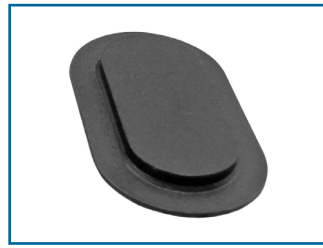
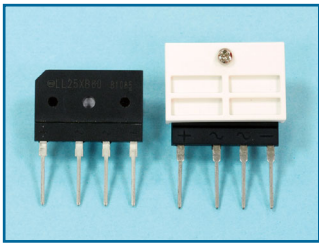
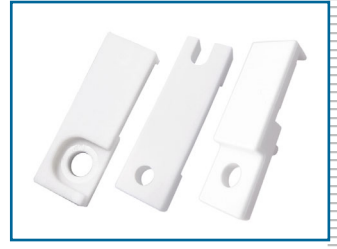
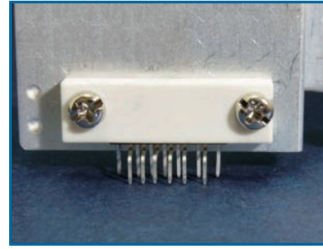
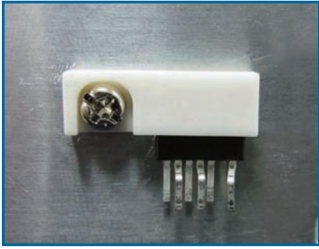
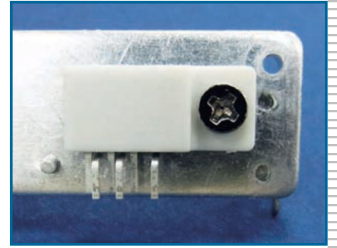
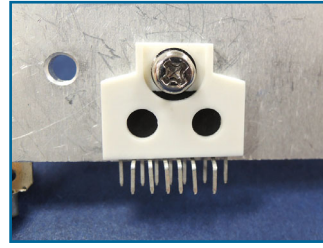
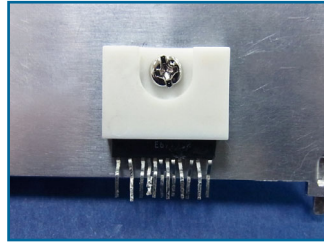
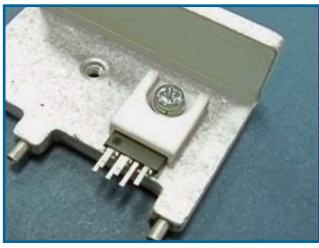

功率IC盖/开关盖

功率IC盖 桥式整流盖 保护盖 开关盖 硅胶盖 绝缘盖 电池盖 末端套管 软质端子保护套 PC
端子保护套 喇叭座 喇叭箱扣 线圈固定座 DRAM固定带 十字型插件式固定器 轨道固定器

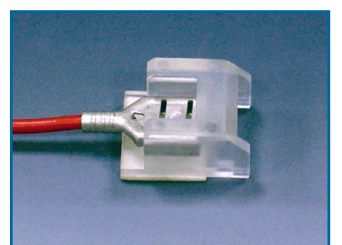
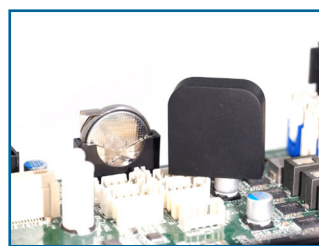
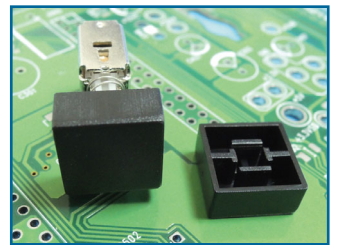
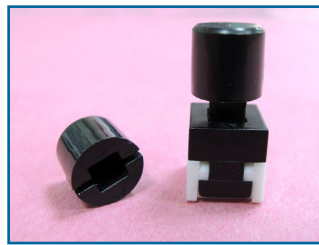
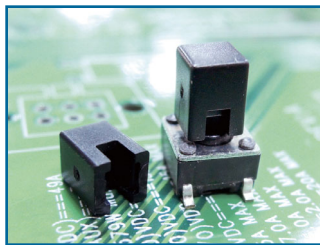
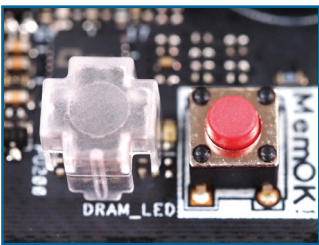
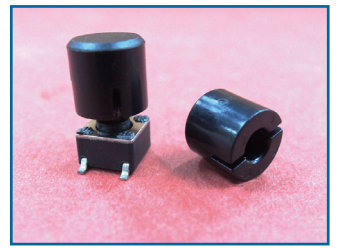
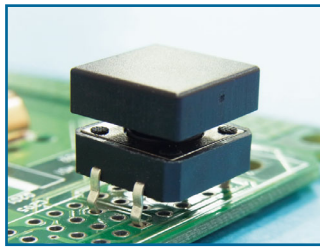
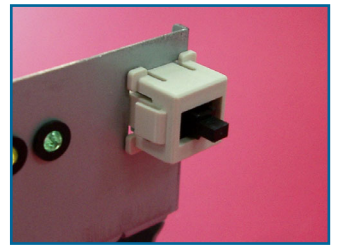
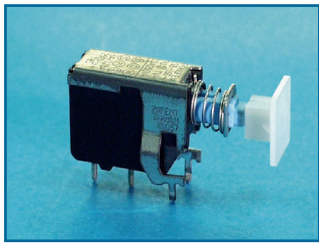

功率IC盖 桥式整流盖 保护盖 开关盖 硅胶盖 绝缘盖 电池盖 末端套管 软质端子保护套 PC
端子保护套 喇叭座 喇叭箱扣 线圈固定座 DRAM固定带 十字型插件式固定器 轨道固定器

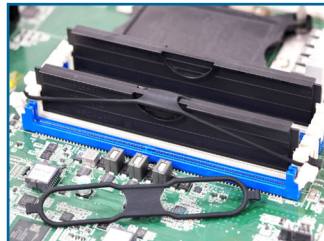
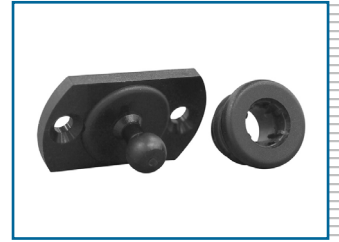
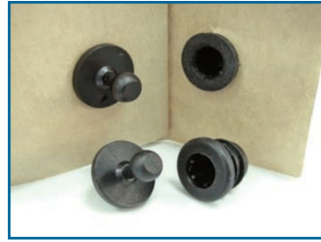
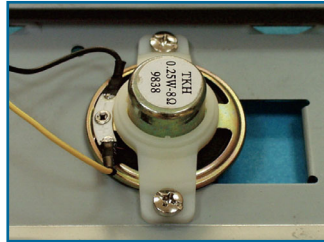
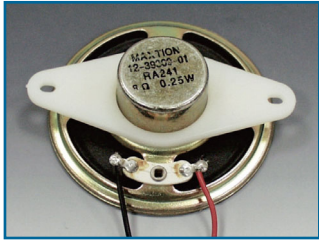

功率IC盖 桥式整流盖 保护盖 开关盖 硅胶盖 绝缘盖 电池盖 末端套管 软质端子保护套 PC
端子保护套 喇叭座 喇叭箱扣 线圈固定座 DRAM固定带 十字型插件式固定器 轨道固定器

功率IC盖 POWER IC COVER

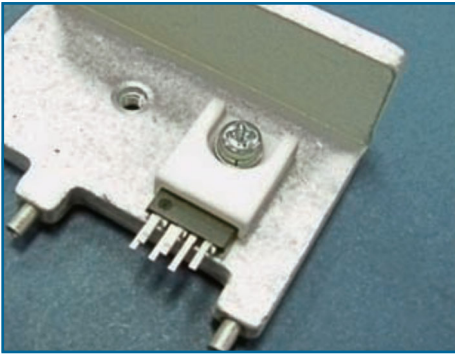

- ◆ MATERIAL : NYLON 66(UL)/PBT(UL) 用途: 功率IC盖, 锁于散热片上之功率IC外壳, 绝缘性特佳, 防止高压跳火, 耐高温, 提高可靠度, 增进美观。
- ◆ FLAME CLASS : 94V-2/94V-0
- ◆ COLOR : NATURAL
- ◆ UNIT: mm

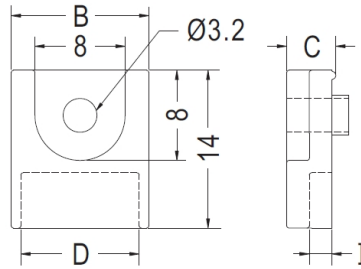

PART NO	B	C	D	I	PACKAGE
GTIC-1	12.2	4.35	10.5	2.0	1000

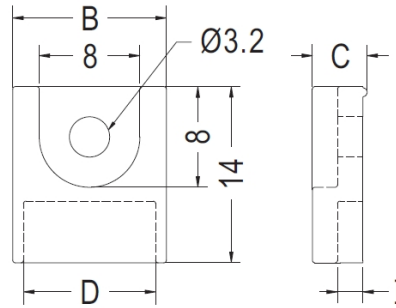
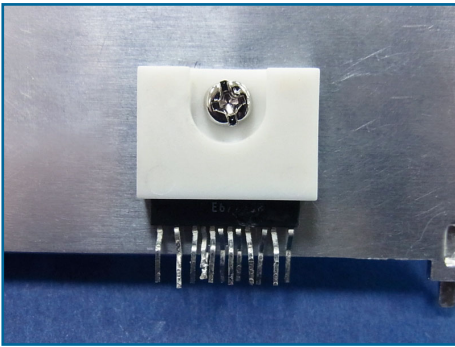

PART NO	B	C	D	I	PACKAGE
GTIC-2	12.2	4.4	10.5	2.0	500
GTIC-3	19.0	4.35	17.0	1.6	1000

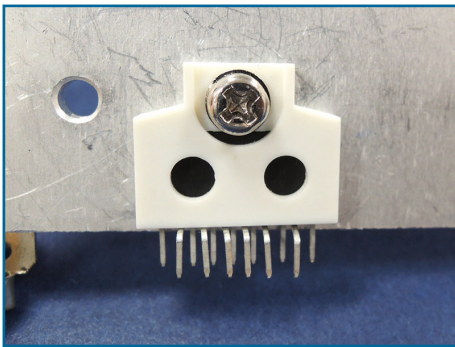

- ◆ MATERIAL : PBT (UL)
- ◆ FLAME CLASS : 94V-0
- ◆ COLOR : NATURAL
- ◆ UNIT: mm

用途: 功率IC盖, 锁于散热片上之功率IC外壳, 绝缘性特佳, 防止高压跳火, 耐高温, 提高可靠度, 增进美观。

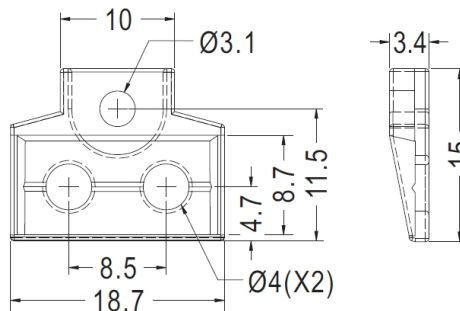

PART NO	PACKAGE
GTIC-10	1000

功率IC盖 POWER IC COVER

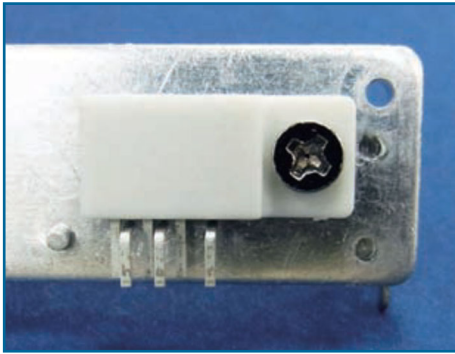

- ◆ MATERIAL : NYLON 66(UL)/PBT(UL) 用途: 功率IC盖, 锁于散热片上之功率IC外壳, 绝缘性特佳, 防止高压跳火, 耐高温, 提高可靠度, 增进美观。
- ◆ FLAME CLASS : 94V-2/94V-0
- ◆ COLOR : NATURAL
- ◆ UNIT: mm

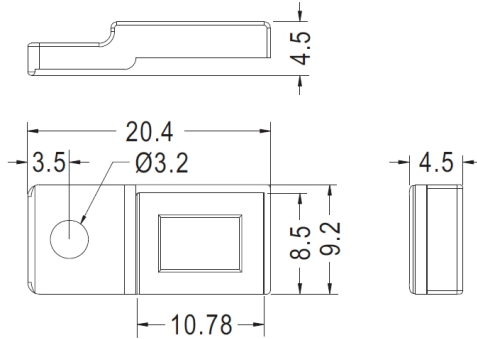

PART NO	PACKAGE
GTIC-4	1000

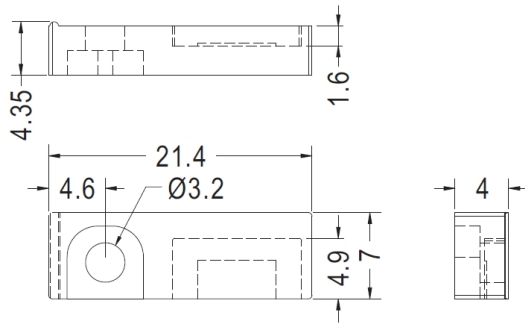
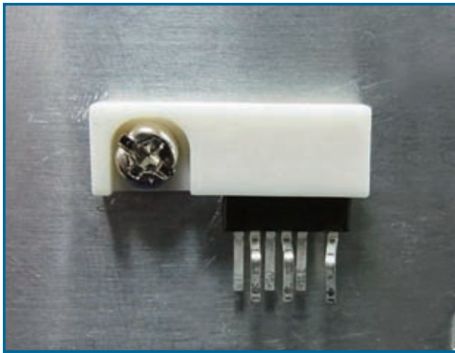

PART NO	PACKAGE
GTIC-5	1000

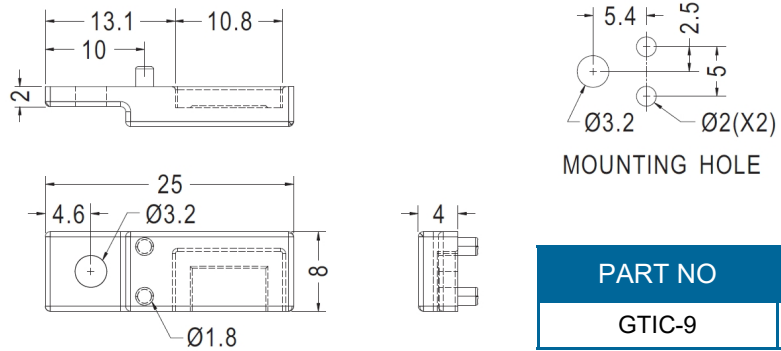
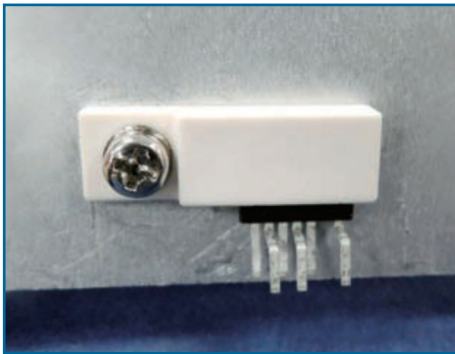

PART NO	PACKAGE
GTIC-9	1000

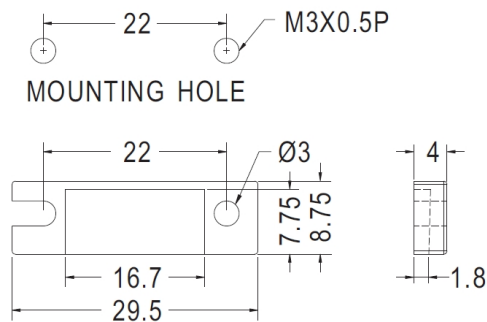
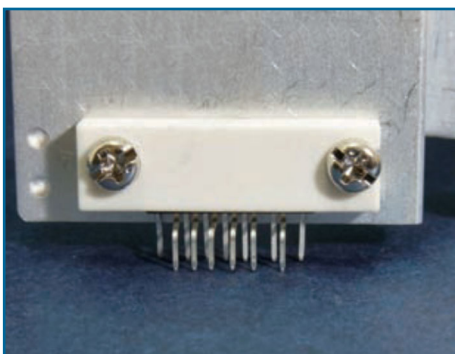

PART NO	PACKAGE
GTIC-6	1000

功率IC盖 POWER IC COVER

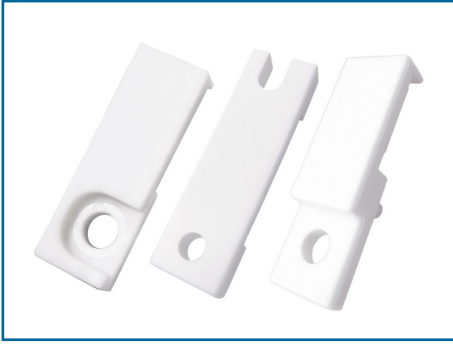

- ◆ MATERIAL : NYLON 66(UL)/PBT(UL) 用途： 功率IC盖，锁于散热片上之功率IC外壳，绝缘性特佳，防止高压跳火，耐高温，提高可靠度，增进美观。
- ◆ FLAME CLASS : 94V-2/94V-0
- ◆ COLOR : NATURAL
- ◆ UNIT: mm

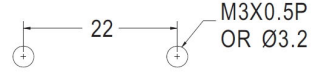

MOUNTING HOLE

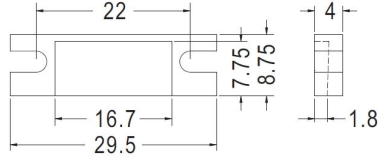

PART NO	PACKAGE
GTIC-7	1000

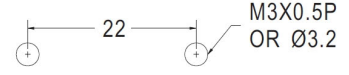

MOUNTING HOLE

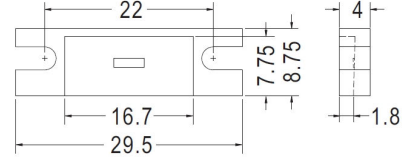

PART NO	PACKAGE
GTIC-8	1000

桥式整流盖 BRIDGE RECTIFIER COVER

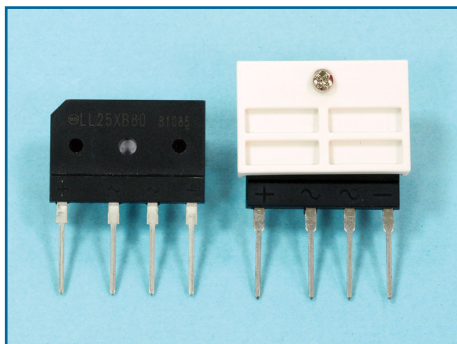

- ◆ MATERIAL : PBT(UL)
- ◆ FLAME CLASS : 94V-0
- ◆ COLOR : NATURAL
- ◆ UNIT: mm

用途：桥式整流盖，锁于散热片上之桥式整流器外壳，绝缘性特佳，防止高压跳火，耐高温，提高可靠度，增进美观。

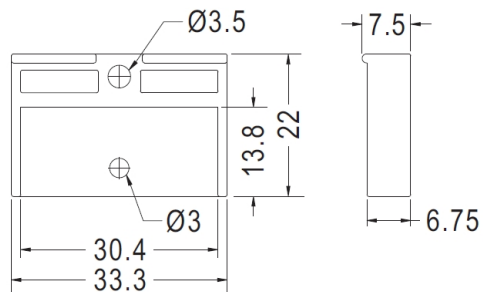

PART NO	PACKAGE
QTC-1	500

保护盖 INSULATED CAP



- ◆ MATERIAL : NYLON 66(UL)/PC(UL) 用途：保护盖，用于HUB挂载孔之防尘与绝缘。
- ◆ FLAME CLASS : 94V-2/94V-0
- ◆ COLOR : BLACK
- ◆ UNIT: mm

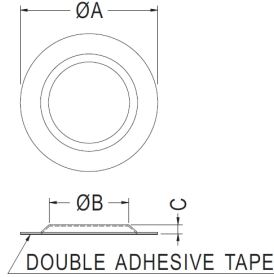

PART NO	A	B	C	PACKAGE
LSCD01	24.0	15.0	2.0	1000
LSCD02	32.0	22.0	2.2	500
LSCD03	37.0	22.0	2.5	500
LSCD08	26.0	18.6	2.3	2000
LSCD09	31.5	18.0	2.4	1000
LSCD11	55.0	40.0	3.5	500
LSCD12	32.0	22.4	3.7	1000



- ◆ MATERIAL : NYLON 66(UL) 用途：保护盖，用于HUB挂载孔之防尘与绝缘。
- ◆ FLAME CLASS : 94V-2/94V-0
- ◆ COLOR : BLACK
- ◆ UNIT: mm

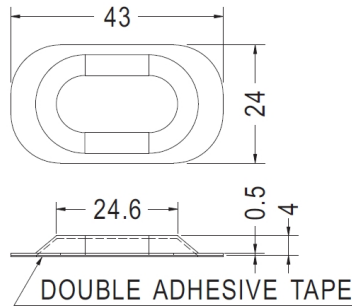

PART NO	PACKAGE
LSCD04	2000

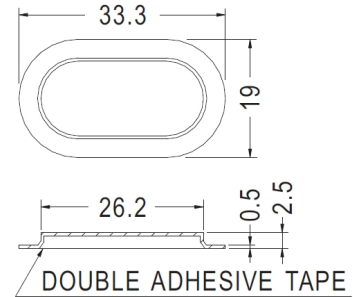

PART NO	PACKAGE
LSCD05	1000

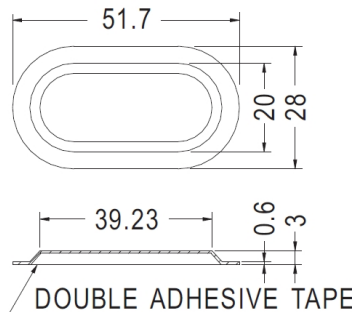

PART NO	PACKAGE
LSCD06	2000

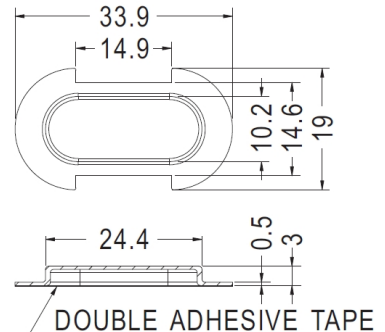

PART NO	PACKAGE
LSCD14	2000

保护盖 INSULATED CAP



- ◆ MATERIAL : NYLON 66(UL)
- ◆ FLAME CLASS : 94V-2/94V-0
- ◆ COLOR : BLACK
- ◆ UNIT: mm

用途：保护盖，用于HUB挂载孔之防尘与绝缘。

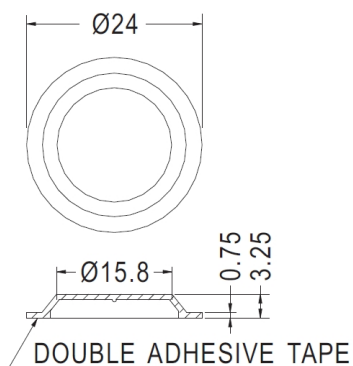

PART NO	PACKAGE
LSCD07	2000



- ◆ MATERIAL : PC (UL)
- ◆ FLAME CLASS : 94V-2/94V-0
- ◆ COLOR : BLACK
- ◆ UNIT: mm

用途：保护盖，用于维修用孔之防尘与绝缘，可用螺丝固定。

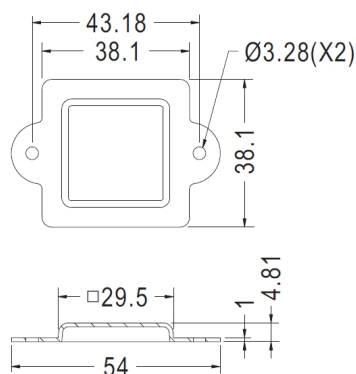

PART NO	PACKAGE
LSCD10	2000

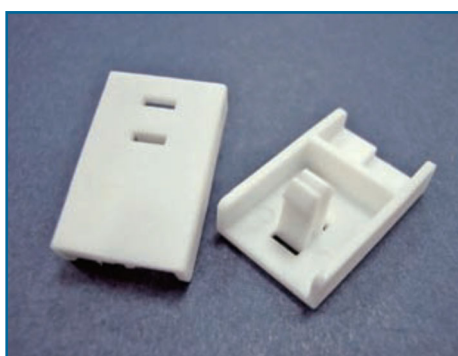

- ◆ MATERIAL : NYLON 66(UL)
- ◆ FLAME CLASS : 94V-2/94V-0
- ◆ COLOR : BLACK
- ◆ UNIT: mm

用途：保护盖，用于零件之防尘与保护。

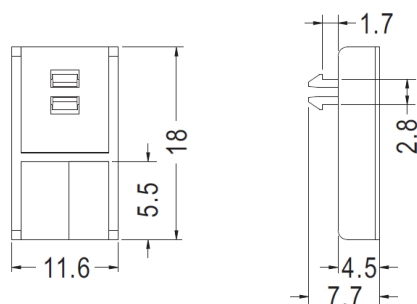

PART NO	PACKAGE
LSCD13	1000

保护盖 INSULATED CAP

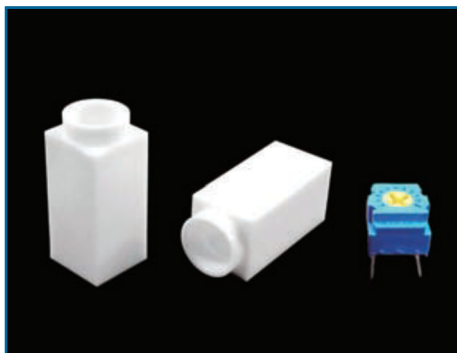

- ◆ MATERIAL : NYLON 66(UL)
- ◆ FLAME CLASS : 94V-2/94V-0
- ◆ COLOR : BLACK/NATURAL
- ◆ UNIT: mm

用途：保护盖，用于机器之可调电阻，灌胶之保护，可配合KMX系列用。

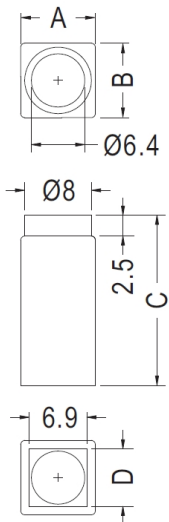

PART NO	A	B	C	D	PACKAGE
LSCD15	8.95	8.95	20.5	6.9	100
LSCD16	8.95	8.95	23.9	6.9	100
LSCD17	8.95	8.95	30.0	6.9	100
LSCD18	8.9	8.6	35.5	6.6	100



- ◆ MATERIAL : NYLON 66(UL)
- ◆ FLAME CLASS : 94V-2/94V-0
- ◆ COLOR : BLACK/NATURAL
- ◆ UNIT: mm

用途：保护盖，用于零件之防尘与保护。

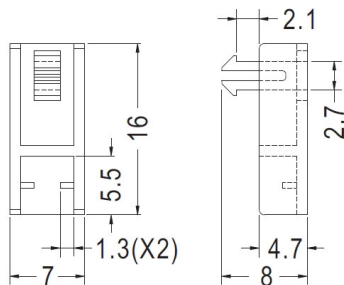

PART NO	PACKAGE
PAHO-032	1000

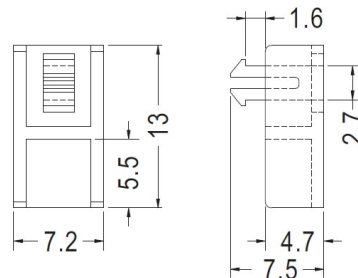

PART NO	PACKAGE
PAHO-063	1000

开关盖 TACT SWITCH CAP



- ◆ MATERIAL : PE
- ◆ COLOR : BLACK
- ◆ UNIT: mm

用途： 开关盖， 开关之绝缘。

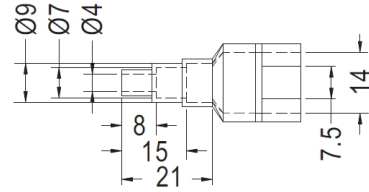
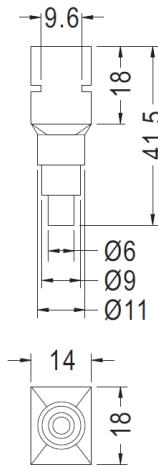

PART NO	PACKAGE
KG-C01	500

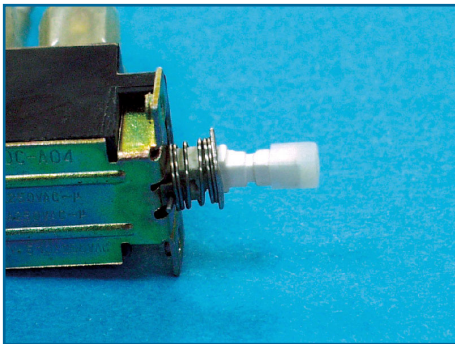

- ◆ MATERIAL : NYLON 66(UL)
- ◆ FLAME CLASS : 94V-2/94V-0
- ◆ COLOR : BLACK/NATURAL
- ◆ UNIT: mm

用途： 开关盖， 用于开关之加长与保护。

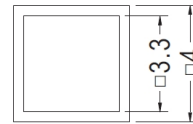
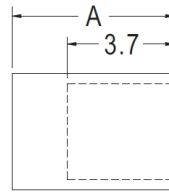

PART NO	A	PACKAGE
KG-C02	5.6	2000
KG-C03	4.7	2000

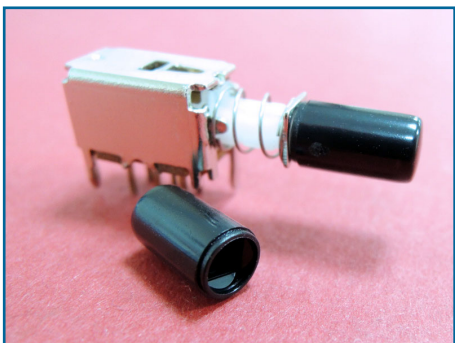

- ◆ MATERIAL : PC+ABS(UL)
- ◆ FLAME CLASS : 94V-2/94V-0
- ◆ COLOR : BLACK
- ◆ UNIT: mm

用途： 开关盖， 用于开关之帽盖。

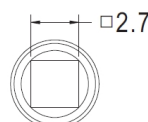
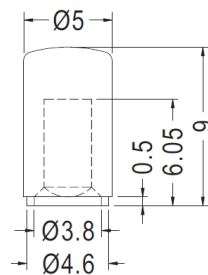

PART NO	PACKAGE
KG-C07	1000

开关盖 TACT SWITCH CAP

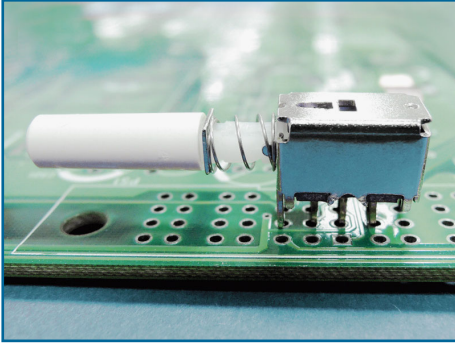

- ◆ MATERIAL : PC+ABS(UL)
- ◆ FLAME CLASS : 94V-2/94V-0
- ◆ COLOR : WHITE
- ◆ UNIT: mm

用途：开关盖，用于开关之帽盖。

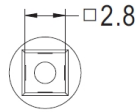
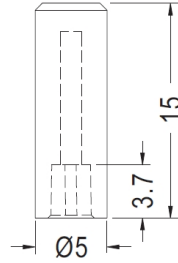

PART NO	PACKAGE
KG-C16	1000

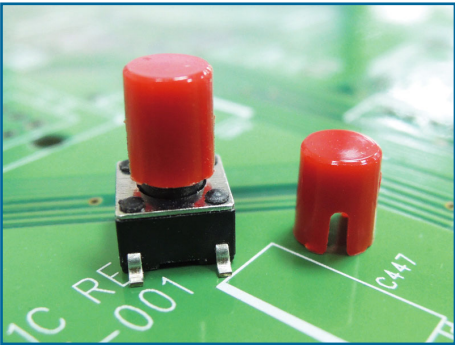

- ◆ MATERIAL : NYLON 66(UL)
- ◆ FLAME CLASS : 94V-2/94V-0
- ◆ COLOR : BLACK/NATURAL/RED/GRAY
- ◆ UNIT: mm

用途：开关盖，用于TACT开关之帽盖。

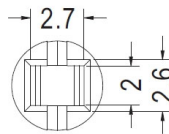
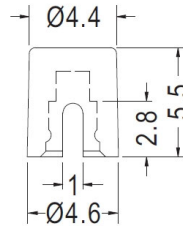

PART NO	PACKAGE
KG-C04	1000

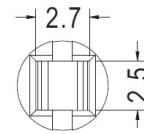
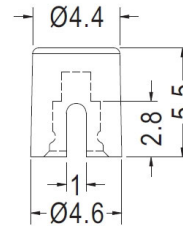

PART NO	PACKAGE
KG-C06	1000

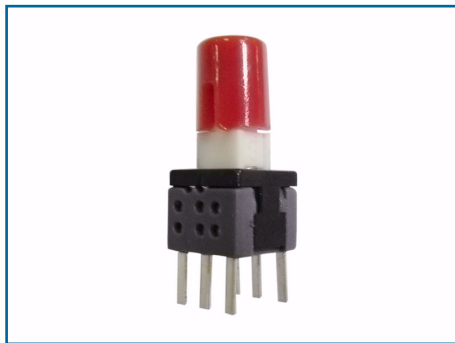

- ◆ MATERIAL : ABS (UL)
- ◆ FLAME CLASS : 94HB
- ◆ COLOR : BLACK/NATURAL
- ◆ UNIT: mm

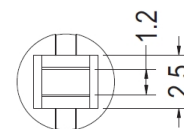
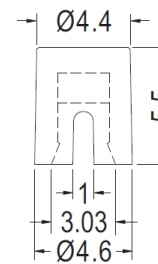

PART NO	PACKAGE
KG-C05	1000

开关盖 TACT SWITCH CAP

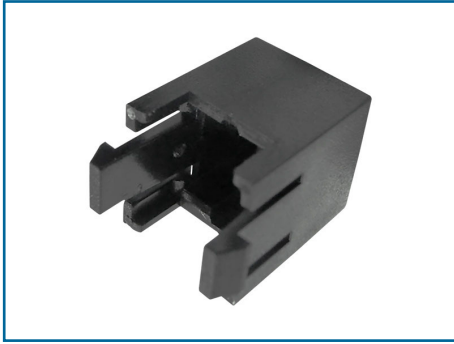

- ◆ MATERIAL : ABS (UL)
- ◆ FLAME CLASS : 94HB
- ◆ COLOR : BLACK
- ◆ UNIT: mm

用途： 开关盖， 将TACT开关固定于机板上。

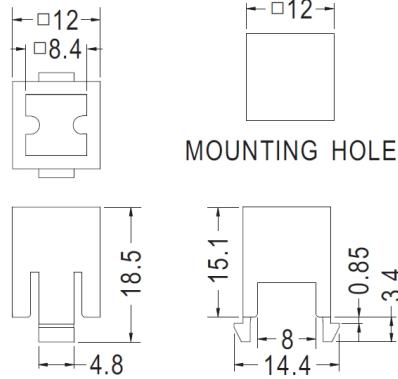

MOUNTING HOLE

PART NO	PACKAGE
KG-C08	1000



用途： 开关盖， 将TACT开关固定于机板上。

- ◆ MATERIAL : NYLON 66(UL)
- ◆ FLAME CLASS : 94V-2/94V-0
- ◆ COLOR : BLACK/NATURAL
- ◆ UNIT: mm

- ◆ MATERIAL : ABS(UL)
- ◆ FLAME CLASS : 94V-0
- ◆ COLOR : BLACK
- ◆ UNIT: mm

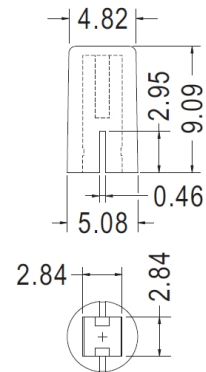
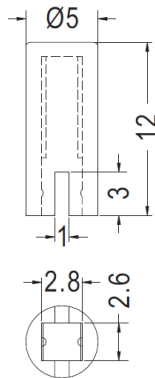

PART NO	PACKAGE
KG-C09	1000

PART NO	PACKAGE
KG-C30	1000



- ◆ MATERIAL : NYLON 66(UL)
- ◆ FLAME CLASS : 94V-2/94V-0
- ◆ COLOR : BLACK/NATURAL
- ◆ UNIT: mm

用途： 开关盖， 用于开关之按键。

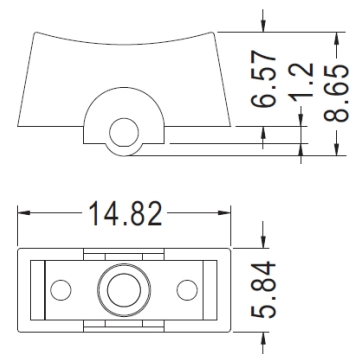

PART NO	PACKAGE
KG-C10	1000

开关盖 TACT SWITCH CAP



- ◆ MATERIAL : PC+ABS(UL)
- ◆ FLAME CLASS : 94V-2/94V-0
- ◆ COLOR : WHITE
- ◆ UNIT: mm

用途：开关盖，用于开关之帽盖。

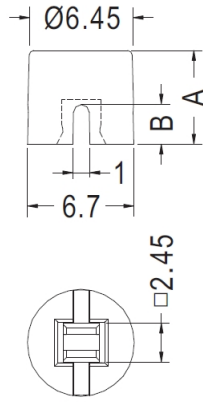

PART NO	A	B	PACKAGE
KG-C11	6.0	2.5	1000
KG-C29	8.0	2.8	1000



- ◆ BODY MATERIAL : NYLON 66(UL)
- ◆ COVER MATERIAL : PC (UL)
- ◆ FLAME CLASS : 94V-2/94V-0
- ◆ COLOR : BLACK
- ◆ UNIT: mm

用途：开关盖，用于开关保护用。

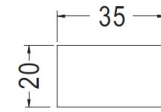
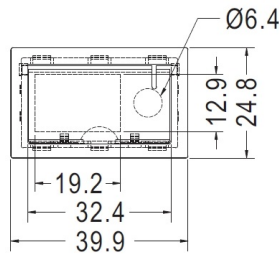

MOUNTING HOLE

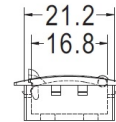
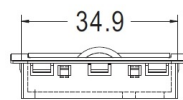

PART NO	PACKAGE
KG-C12	21



- ◆ MATERIAL : NYLON 66(UL)
- ◆ FLAME CLASS : 94V-2/94V-0
- ◆ COLOR : BLACK/NATURAL
- ◆ UNIT: mm

用途：开关盖，用于开关之按键。

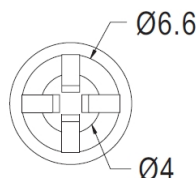
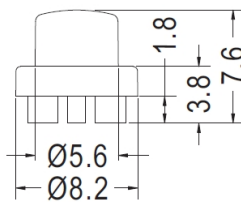

PART NO	PACKAGE
KG-C15	1000

开关盖 TACT SWITCH CAP

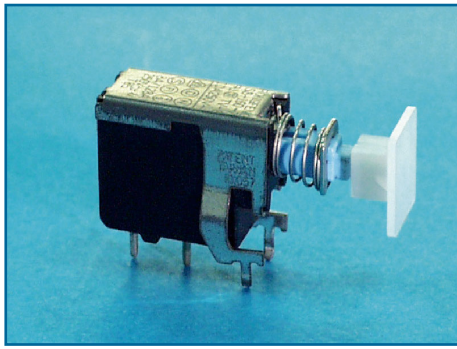

- ◆ MATERIAL : PC+ABS (UL)/NYLON 66(UL) 用途： 开关盖， 用于开关之帽盖。
- ◆ FLAME CLASS : 94V-2/94V-0
- ◆ COLOR : BLACK/NATURAL/GRAY
- ◆ UNIT: mm

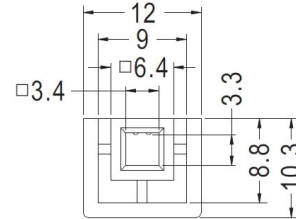
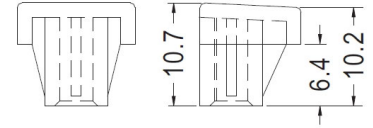
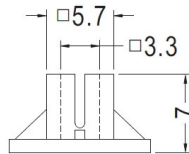
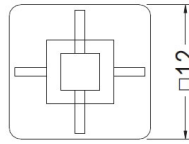

PART NO	PACKAGE
KG-C13	1000

PART NO	PACKAGE
KG-C14	1000



- ◆ MATERIAL : PC+ABS(UL)
- ◆ FLAME CLASS : 94V-0
- ◆ COLOR : BLACK/GRAY
- ◆ UNIT: mm

用途： 开关盖， 用于开关之帽盖。

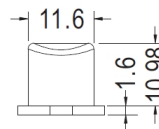
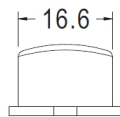
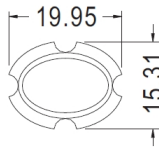

PART NO	PACKAGE
KG-C17	1000



- ◆ MATERIAL : PC+ABS(UL)
- ◆ FLAME CLASS : 94V-0/94V-2
- ◆ COLOR : BLACK/NATURAL
- ◆ UNIT: mm

用途： 开关盖， 将TACT开关固定于机板上。

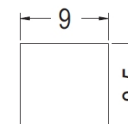
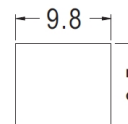
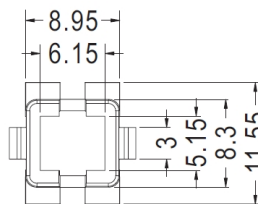

MOUNTING HOLE THICKNESS 0.6~0.8

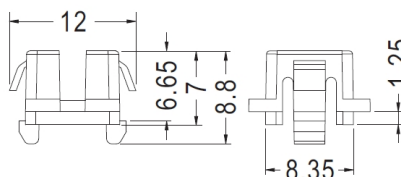

PART NO	PACKAGE
KG-C18	1000

开关盖 TACT SWITCH CAP

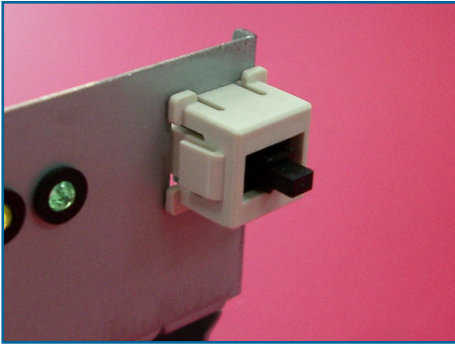

用途： 开关盖，将TACT开关固定于机板上。

- ◆ MATERIAL : PC+ABS(UL)
- ◆ FLAME CLASS : 94V-0
- ◆ COLOR : NATURAL/BLACK
- ◆ UNIT: mm

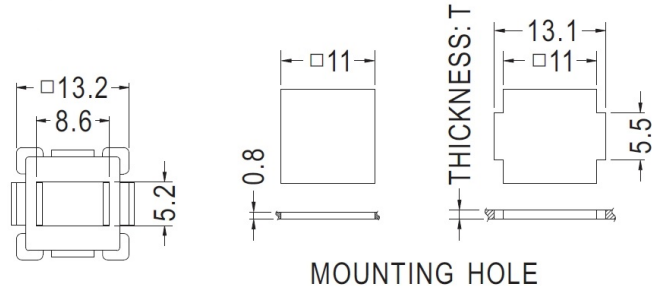

- ◆ MATERIAL : ABS(UL)
- ◆ FLAME CLASS : 94V-0/94HB
- ◆ COLOR : NATURAL/BLACK/COMPUTER
- ◆ UNIT: mm

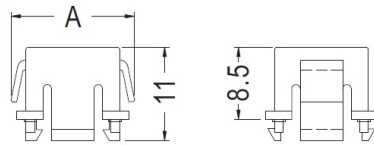
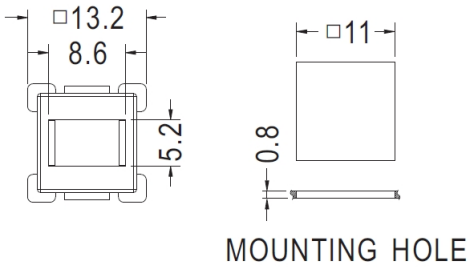

PART NO	A	T	PACKAGE
KG-C19	14.5	1.0	1000
KG-C20	14.3	1.4	1000

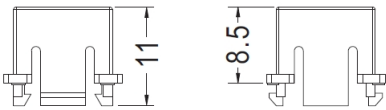

PART NO	PACKAGE
KG-21	21

- ◆ MATERIAL : ABS(UL)
- ◆ FLAME CLASS : 94HB
- ◆ COLOR : NATURAL/COMPUTER
- ◆ UNIT: mm

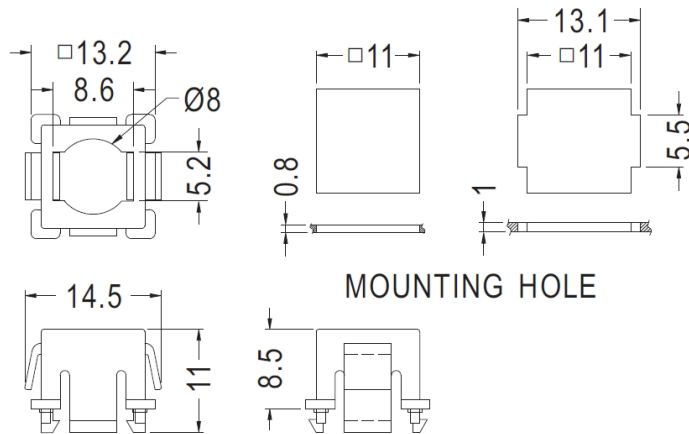

PART NO	PACKAGE
KG-C23	1000

开关盖 TACT SWITCH CAP



- ◆ MATERIAL : NYLON 66(UL)
- ◆ FLAME CLASS : 94V-2/94V-0
- ◆ COLOR : BLACK/NATURAL
- ◆ UNIT: mm

用途： 开关盖，用于TACT开关之帽盖。

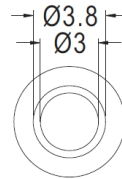
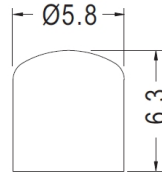

PART NO	PACKAGE
KG-C22	1000

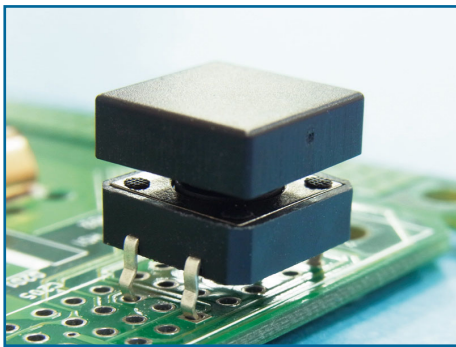

- ◆ MATERIAL : ABS(UL)
- ◆ FLAME CLASS : 94HB
- ◆ COLOR : BLACK
- ◆ UNIT: mm

用途： 开关盖，用于TACT开关之帽盖。

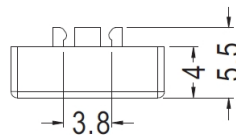
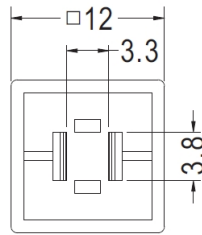

PART NO	PACKAGE
KG-C24	1000



- ◆ MATERIAL : PC
- ◆ COLOR : TRANSPARENT
- ◆ UNIT: mm

用途： 开关盖，用于电源插座防尘与保护。

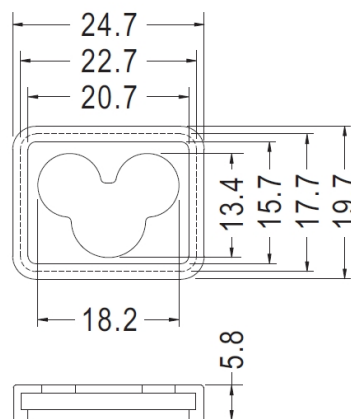

PART NO	PACKAGE
KG-C25	1000

开关盖 TACT SWITCH CAP

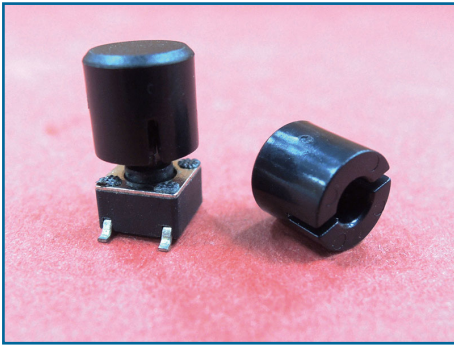

用途： 开关盖， 将TACT开关固定于机板上。

- ◆ MATERIAL : ABS (UL)
- ◆ FLAME CLASS : 94HB
- ◆ COLOR : BLACK
- ◆ UNIT: mm

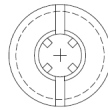
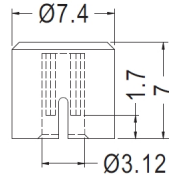

PART NO	PACKAGE
KG-C26	1000

- ◆ MATERIAL : ABS
- ◆ COLOR : WHITE
- ◆ UNIT: mm

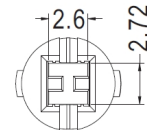
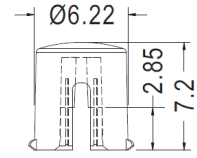

PART NO	PACKAGE
KG-C28	1000

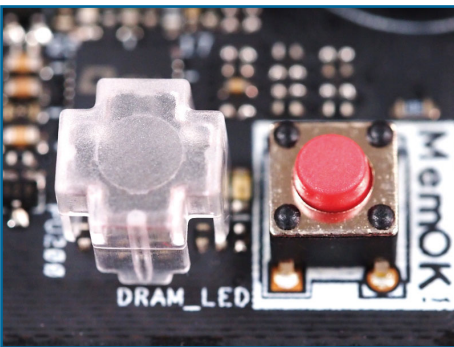

- ◆ MATERIAL : PC (UL)
- ◆ FLAME CLASS : 94V-2
- ◆ COLOR : TRANSPARENT
- ◆ UNIT: mm

用途： 开关盖， 防止TACT开关之误触。

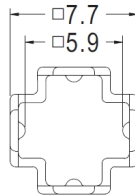
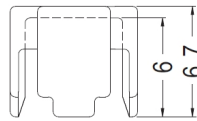

PART NO	PACKAGE
KG-C27	1000

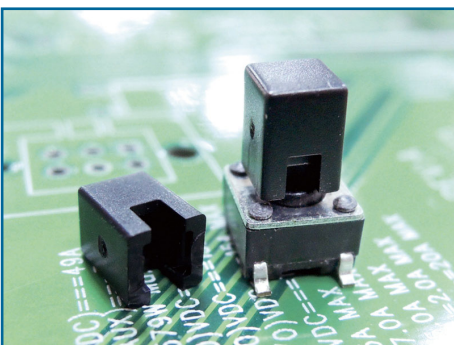

- ◆ MATERIAL : ABS (UL)
- ◆ FLAME CLASS : 94HB
- ◆ COLOR : BLACK
- ◆ UNIT: mm

用途： 开关盖， 用于TACT开关之帽盖。

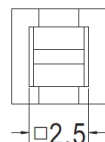
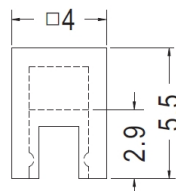

PART NO	PACKAGE
KG-C31	1000

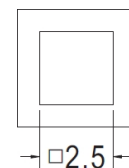
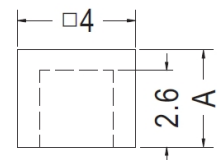

PART NO	PACKAGE
KG-C32	3.3 2000
KG-C33	4.0 2000

开关盖 TACT SWITCH CAP

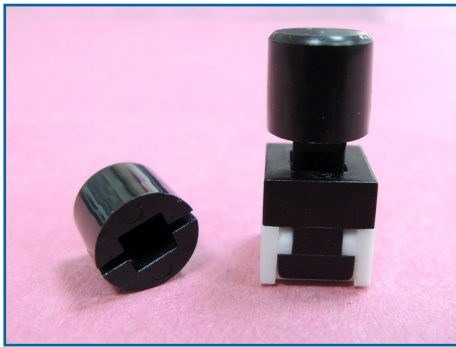

- ◆ MATERIAL : ABS (UL)
- ◆ FLAME CLASS : 94VHB
- ◆ COLOR : BLACK
- ◆ UNIT: mm

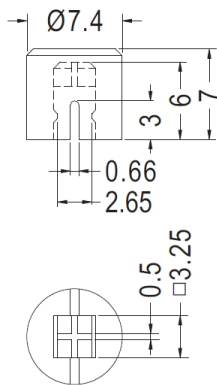

PART NO	PACKAGE
KG-C35	1000

用途：开关盖，用于TACT开关之帽盖。

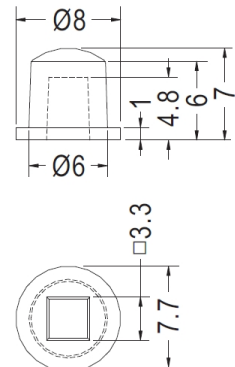

PART NO	PACKAGE
KG-C34	1000

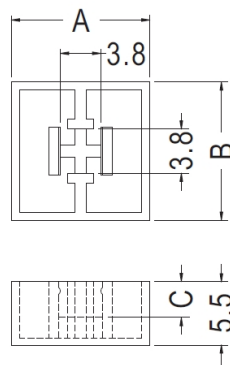
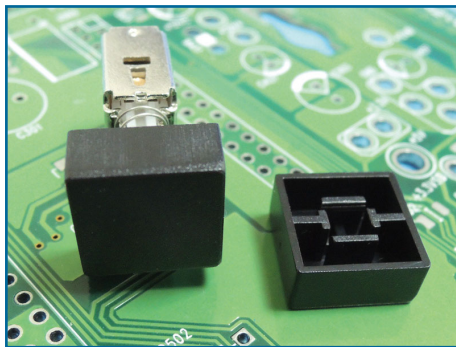

PART NO	A	B	C	PACKAGE
KG-C36	12.0	12.0	3.1	1000
KG-C37	9.0	9.0	2.8	1000

开关盖



- ◆ MATERIAL : ABS (UL)/NYLON 66(UL) 用途：开关盖，将TACT开关固定于机板上。
- ◆ FLAME CLASS : 94HB/94V-2/94V-0
- ◆ COLOR : BLACK/NATURAL
- ◆ UNIT: mm

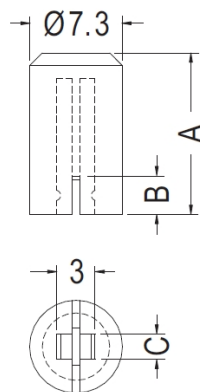

PART NO	A	B	C	PACKAGE
KG-C39	12.7	3.0	2.0	1000
KG-C40	12.7	4.2	3.0	1000
KG-C41	11.6	3.0	2.0	1000

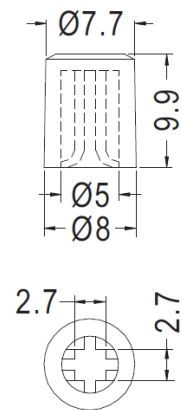

PART NO	PACKAGE
KG-C38	1000

硅胶盖 SILICON RUBBER CAP



- ◆ MATERIAL : SILICON RUBBER
- ◆ COLOR : BLACK
- ◆ UNIT: mm

用途：硅胶盖，用于零件之保护，防尘美观。

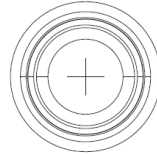
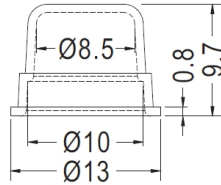

PART NO	PACKAGE
TF-1	1000



- ◆ MATERIAL : SILICON RUBBER (UL)
- ◆ FLAME CLASS : 94V-0
- ◆ COLOR : BLACK
- ◆ UNIT: mm

用途：硅胶盖，用于零件之保护，防尘美观。

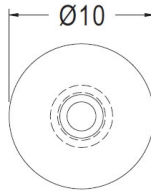
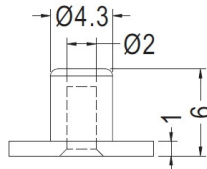

PART NO	PACKAGE
TF-3	1000

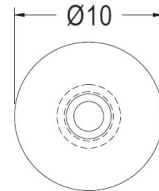
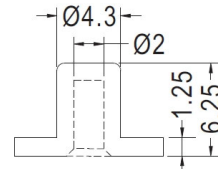

PART NO	PACKAGE
TF-2	1000



- ◆ MATERIAL : SILICON RUBBER
- ◆ COLOR : WHITE
- ◆ UNIT: mm

用途：硅胶盖，用于零件之保护，防尘美观。

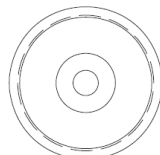
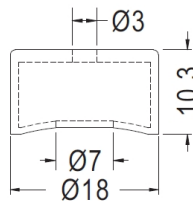

PART NO	PACKAGE
TF-4	1000

硅胶盖 SILICON RUBBER CAP



- ◆ MATERIAL : SILICON RUBBER
- ◆ COLOR : BLACK
- ◆ UNIT: mm

用途：硅胶盖，用于零件之保护，
防尘美观。

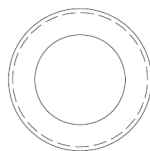
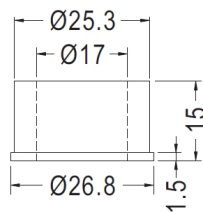

PART NO	PACKAGE
TF-5	1000

绝缘盖 INSULATOR COVER



- ◆ MATERIAL : NYLON 66(UL)
- ◆ FLAME CLASS : 94V-0/94V-2
- ◆ COLOR : BLACK/NATURAL
- ◆ UNIT: mm

用途：绝缘盖，用于波段开关旋钮。

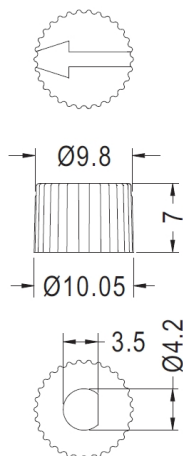

PART NO	PACKAGE
JYG-1	1000

电池盖 BATTERY COVER



- ◆ MATERIAL : SILICON RUBBER(UL) 用途： 电池盖， 用于电池盖之防尘与保护。
- ◆ FLAME CLASS : 94V-0
- ◆ COLOR : BLACK
- ◆ UNIT: mm

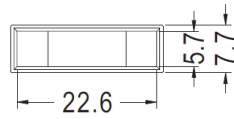
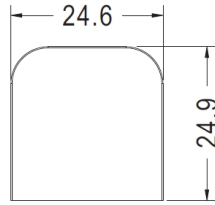

PART NO	PACKAGE
BATC-1	1000

末端套管 VCP CAP 末端护套



用途：末端套管，特殊管末端切开时之保护套，及各种电线，电缆运送途中防湿防尘用。

- ◆ MATERIAL : SOFT P.V.C
- ◆ COLOR : BLACK/NATURAL/RED/YELLOW/GREEN/BLUE/WHITE
- ◆ UNIT: mm

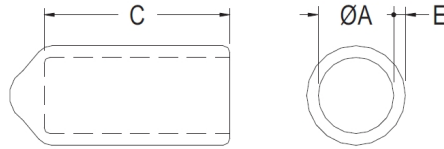

PART NO	A	B	C	PACKAGE
VCPL-01	2.0	12.0	0.8	2000
VCPL-02	2.6	7.0	0.8	2000
VCPL-03	2.6	8.0	0.8	2000
VCPL-04	2.6	9.0	0.8	2000
VCPL-06	3.2	6.0	0.8	2000
VCPL-07	3.2	10.0	0.8	2000
VCPL-08	3.2	13.0	0.8	2000
VCPL-09	4.0	6.0	0.8	1000
VCPL-10	4.0	8.0	0.8	1000
VCPL-11	4.8	9.0	1.0	1000
VCPL-12	4.8	13.0	0.8	1000
VCPL-13	5.7	8.0	1.0	1000
VCPL-14	5.7	10.	1.0	1000
VCPL-15	5.7	13.0	1.0	1000
VCPL-16	6.0	8.0	1.0	1000
VCPL-17	6.0	12.0	1.0	1000

PART NO	A	B	C	PACKAGE
VCPL-18	6.5	13.0	1.0	1000
VCPL-19	7.0	13.0	1.0	1000
VCPL-20	7.0	20.0	1.0	1000
VCPL-21	7.6	8.0	1.0	1000
VCPL-22	7.6	13.0	1.0	1000
VCPL-23	8.0	8.0	1.0	1000
VCPL-24	8.0	10.0	1.0	1000
VCPL-25	8.5	9.0	1.0	1000
VCPL-26	8.5	15.0	1.0	1000
VCPL-27	9.5	16.0	1.0	1000
VCPL-28	10.0	20.0	1.0	1000
VCPL-29	11.4	20.0	1.2	1000
VCPL-30	12.0	16.0	1.2	500
VCPL-31	14.0	35.0	1.2	500
VCPL-32	15.0	14.0	12.	500
VCPL-33	17.8	13.0	1.2	500
VCPL-34	22.0	16.0	1.2	200



- ◆ MATERIAL : SOFT P.V.C
- ◆ COLOR : BLACK
- ◆ UNIT: mm

用途：末端套管，用于连接器之绝缘与防尘。

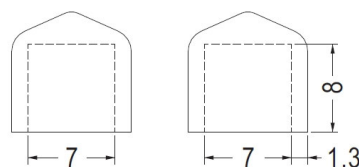

PART NO	PACKAGE
VCPL-38	1000

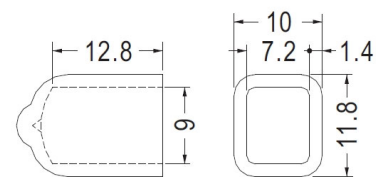

PART NO	PACKAGE
VCPL-35	1000

末端套管 VCP CAP 末端护套



- ◆ MATERIAL : TPE (UL)
- ◆ FLAME CLASS : 94HB
- ◆ COLOR : BLACK
- ◆ UNIT: mm

用途：末端套管，特殊管末端切开时之保护套，及各种电线，电缆运送途中防湿防尘用。

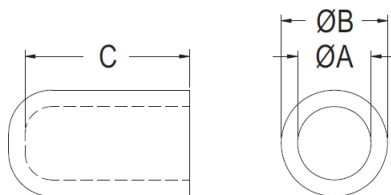

PART NO	A	B	C	PACKAGE
VCPL-36	4.0	5.5	13.0	1000
VCPL-37	7.0	9.8	18.0	1000
VCPL-39	7.0	11.0	10.5	1000
VCPL-40	4.0	5.5	13.0	1000
VCPL-41	2.4	5.6	6.6	1000
VCPL-42	2.4	6.3	12.2	1000
VCPL-43	2.9	6.3	12.2	1000
VCPL-44	3.2	5.5	9.7	1000
VCPL-45	3.2	7.0	14.2	1000
VCPL-46	4.0	5.5	9.7	2000
VCPL-47	7.9	9.5	13.2	1000

软质端子保护套 TERMINAL SOFT SLEEVES



- ◆ MATERIAL : SOFT V.P.C
- ◆ COLOR : NATURAL
- ◆ UNIT: mm

用途：软质端子保护套，用于端子压着后端子与外界间之绝缘。

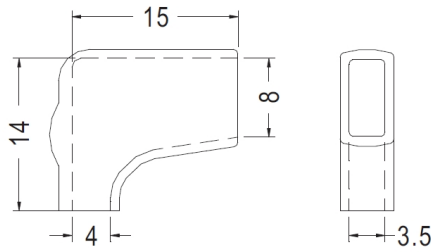

WIRE SIZE(O.D) Ø4.0

PART NO	PACKAGE
FSV001	1000

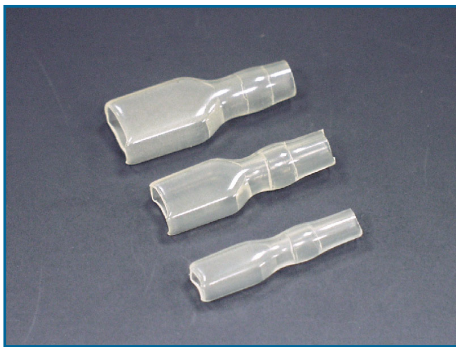

- ◆ MATERIAL : SOFT V.P.C
- ◆ COLOR : NATURAL/BLACK
- ◆ UNIT: mm

用途：软质端子保护套，用于端子压着后端子与外界间之绝缘。

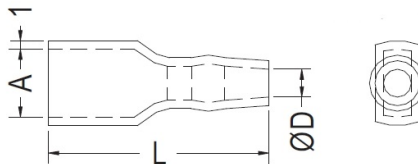

FLAT INSULATING SLEEVES

- 如需UL認可材質，請在料號尾碼加UL下單
- Please add UL after Part Number for UL certified material.

SERIES-110

PART NO	A	D	L	WIRE SIZE	PACKAGE
FSV002	4.0	2.0	22.0	2.0	1000
FSV003	4.0	2.5	22.0	2.5	1000
FSV004	4.0	2.8	22.0	2.8	1000
FSV005	4.0	3.0	22.0	3.0	1000
FSV006	4.0	3.5	22.0	3.0	1000

SERIES-187

PART NO	A	D	L	WIRE SIZE	PACKAGE
FSV007	5.8	2.5	22.0	2.5	1000
FSV008	5.8	3.0	22.0	3.0	1000
FSV009	5.8	3.5	22.0	3.5	1000
FSV010	5.8	4.0	22.0	3.5	1000

SERIES-205

PART NO	A	D	L	WIRE SIZE	PACKAGE
FSV011	6.5	2.5	24.0	2.5	1000
FSV012	6.5	3.0	24.0	3.0	1000
FSV013	6.5	3.0	37.0	3.0	1000
FSV014	6.5	3.5	24.0	3.5	1000
FSV015	6.5	4.0	24.0	4.0	1000

SERIES-50

PART NO	A	D	L	WIRE SIZE	PACKAGE
FSV016	7.8	3.0	26.0	3.0	1000
FSV017	7.8	3.5	27.0	3.5	1000
FSV018	8.0	4.0	27.0	4.0	1000
FSV019	8.0	4.5	27.0	4.5	1000
FSV020	7.8	5.0	27.0	5.0	1000
FSV021	9.5	3.5	26.0	3.5	1000

软质端子保护套 TERMINAL SOFT SLEEVES



- ◆ MATERIAL : SOFT V.P.C
- ◆ COLOR : NATURAL/BLUE
- ◆ UNIT: mm

用途：软质端子保护套，用于端子压着后端子与外界间之绝缘。

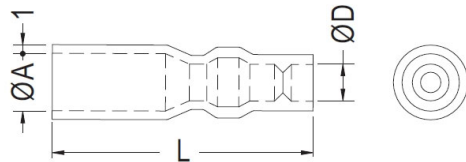

PART NO	A	D	L	PACKAGE
FSV022	5.0	2.8	32.0	1000
FSV023	5.0	2.5	33.0	1000
FSV024	5.0	2.8	33.0	1000
FSV025	5.0	3.1	33.0	1000
FSV026	5.2	3.5	33.0	1000
FSV027	5.5	4.0	33.0	1000

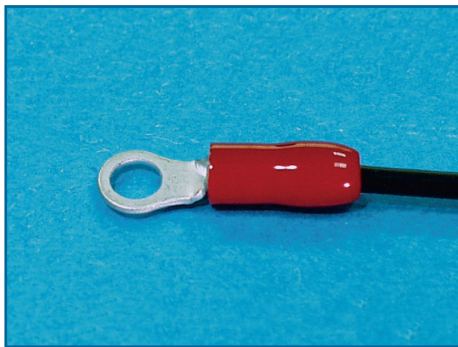

用途：软质端子保护套，用于端子压着后端子与外界间之绝缘，可做为线材之分色标记，安全美观。

- ◆ MATERIAL : SOFT P.V.C
- ◆ COLOR : BLACK/RED/YELLOW/GREEN/BLUE/WHITE
- ◆ UNIT: mm

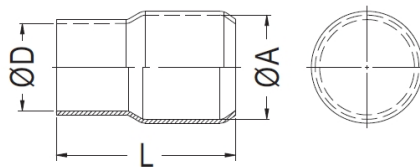

PART NO	WIRE mm ²	A	D	L	PACKAGE
FSV028	1.25	3.3	3.1	15.0	100
FSV029	2.0	4.5	3.7	16.0	100
FSV030	3.5	5.7	4.1	18.0	100
FSV031	5.5	5.7	5.2	20.0	100
FSV032	8.0	7.2	6.2	21.0	100
FSV033	14.0	10.0	8.0	28.0	100
FSV034	22.0	12.0	9.5	29.0	100
FSV035	38.0	14.0	11.8	34.0	100
FSV036	60.0	17.0	13.9	42.0	100
FSV037	70.0	17.9	15.1	45.0	100
FSV038	80.0	19.5	16.0	46.0	50
FSV039	100.0	22.0	18.0	55.0	50

PART NO	WIRE mm ²	A	D	L	PACKAGE
FSV040	125.0	24.4	20.0	60.0	50
FSV041	150.0	26.0	22.0	65.0	50
FSV042	185.0	29.0	24.0	66.7	50
FSV043	200.0	32.2	24.0	69.0	50
FSV044	250.0	37.5	26.5	75.0	50
FSV045	325.0	37.5	30.0	75.0	25
FSV046	400.0	45.1	37.5	83.0	25
FSV047	500.0	48.2	40.2	85.0	25
FSV048	630.0	53.8	45.2	93.0	25

PC端子保护套 TERMINAL HOUSING

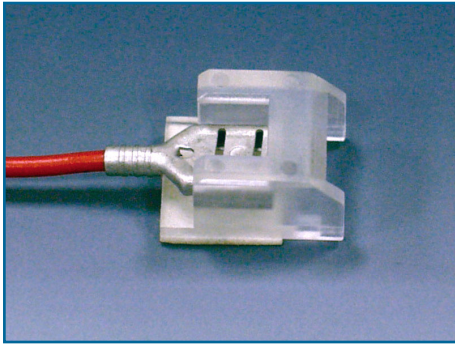

- ◆ MATERIAL : PC (UL)
- ◆ FLAME CLASS: 94V-2
- ◆ COLOR : NATURAL
- ◆ UNIT: mm

用途：PC端子保护套，用于电池端子之绝缘与保护。

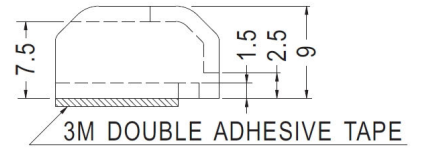
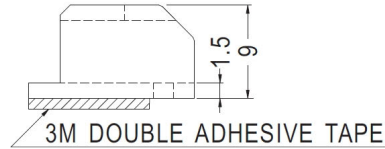
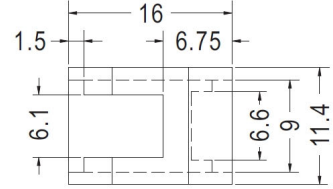
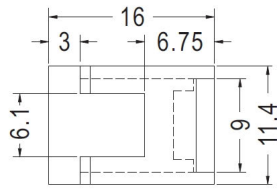

PART NO	PACKAGE
PCDK-1	1000

PART NO	PACKAGE
PCDK-2	1000

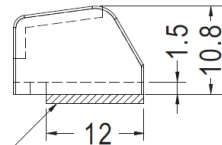
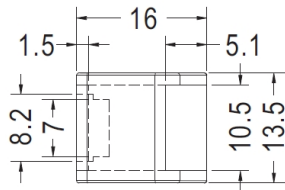

PART NO	PACKAGE
PCDK-3	1000

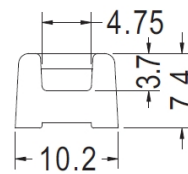
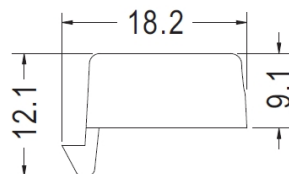
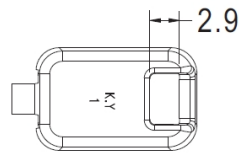

PART NO	PACKAGE
PCDK-4	1000

喇叭座 SPEAKER HOLDER

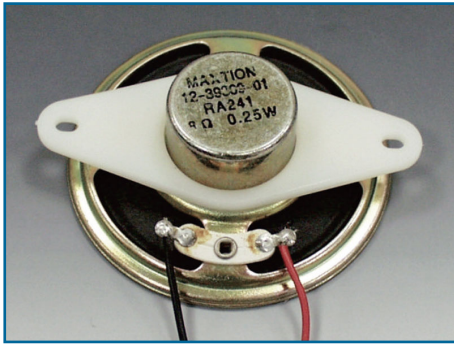

- ◆ MATERIAL : NYLON 66(UL)
- ◆ FLAME CLASS : 94V-0/94V-2
- ◆ COLOR : BLACK/NATURAL
- ◆ UNIT: mm

用途：喇叭座，将Ø50喇叭固定于机板上。

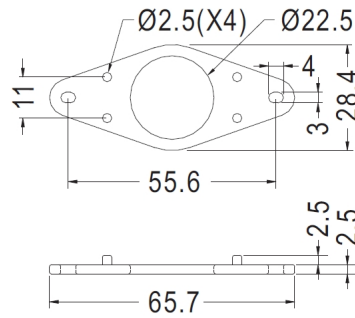

PART NO	PACKAGE
SPKS-1	250

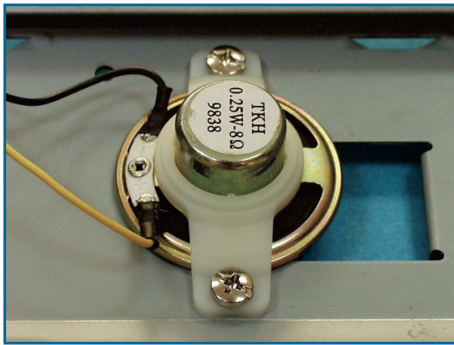

- ◆ MATERIAL : NYLON 66(UL)
- ◆ FLAME CLASS : 94V-0/94V-2
- ◆ COLOR : BLACK/NATURAL
- ◆ UNIT: mm

用途：喇叭座，将Ø38喇叭固定于机板上。

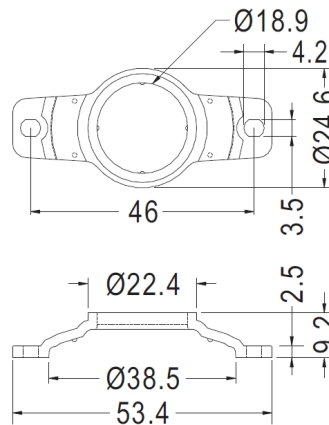

PART NO	PACKAGE
SPKS-2	250

喇叭箱扣 TERMINAL HOUSING



用途：喇叭箱扣，固定音箱外盖用。

- ◆ PIN MATERIAL : NYLON 66 (UL)
- ◆ FLAME CLASS: 94V-2/94V-0
- ◆ COLOR : BLACK
- ◆ UNIT: mm

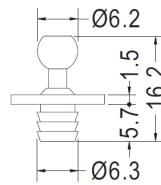
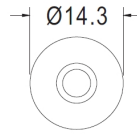

PIN
CHASSIS Ø6.1
THICKNESS 6.4

- ◆ BODY MATERIAL : TPE
- ◆ COLOR : BLACK
- ◆ UNIT: mm

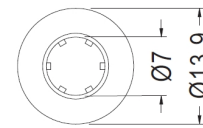
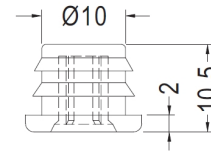

BODY
CHASSIS Ø10.5
THICKNESS 2.5

PART NO	PACKAGE
SPKS01	500

PART NO	PACKAGE
SPKS02	500



- ◆ PIN MATERIAL : NYLON 66 (UL)
- ◆ FLAME CLASS: 94V-2/94V-0
- ◆ COLOR : BLACK
- ◆ UNIT: mm

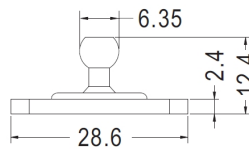
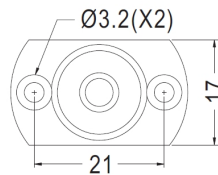

PIN

- ◆ BODY MATERIAL : TPU
- ◆ COLOR : BLACK
- ◆ UNIT: mm

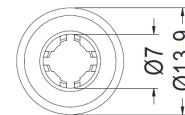
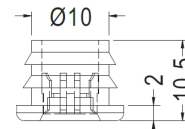

BODY
CHASSIS Ø10.5
THICKNESS 2.5

PART NO	PACKAGE
SPKS03	500

PART NO	PACKAGE
SPKS04	500

线圈固定座 COIL HOLDER 铁粉芯线圈



- ◆ MATERIAL : PBT 66(UL)
- ◆ FLAME CLASS : 94V-0
- ◆ COLOR : NATURAL
- ◆ UNIT: mm

用途：线圈固定座，将铁粉芯线圈固定于PC板上。

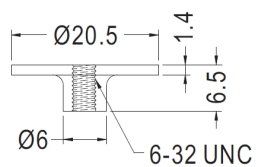

PART NO	PACKAGE
LTRMH-1	500

DRAM固定带 DRAM FIXATION STRAP

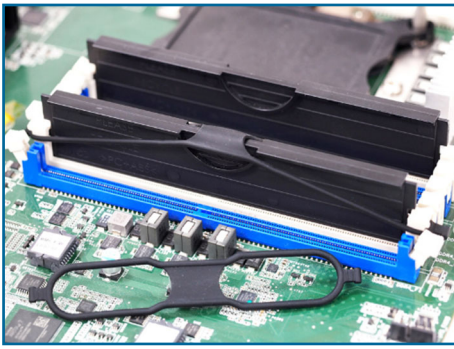

- ◆ MATERIAL : SILICON RUBBER 用途: DRAM固定带, 用于DRAM内存卡固定。
- ◆ COLOR : BLACK
- ◆ UNIT: mm

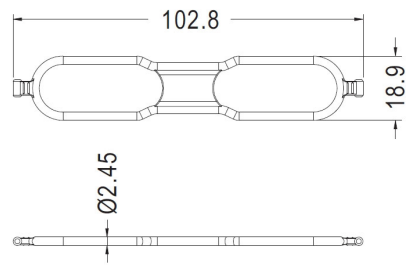

PART NO	PACKAGE
DRAM-1	100

十字型插件式固定器 PLUG-IN SWITCH CROSS TYPE



- ◆ MATERIAL : POM
- ◆ COLOR : BLACK
- ◆ UNIT: mm

用途：十字型插件式固定器，用于零件的扣件。

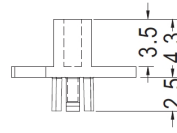
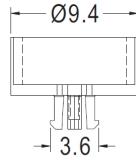
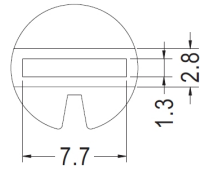

PART NO	PACKAGE
PSCT-1	1000

轨道固定器 RAIL MOUNT

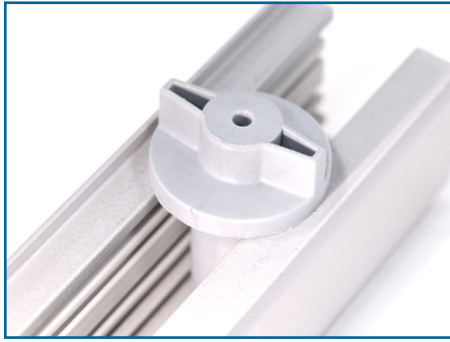

- ◆ PIN MATERIAL : NYLON 66 (UL) 用途: 轨道固定器, 用于轨道的固定。
- ◆ FLAME CLASS: 94V-2/94V-0
- ◆ COLOR : BLACK
- ◆ UNIT: mm

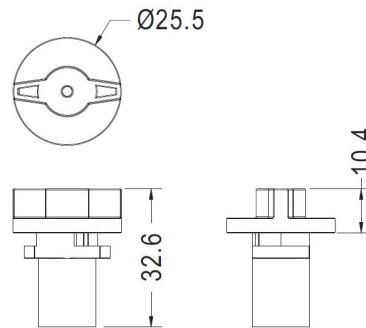

PART NO	PACKAGE
RM-1	100

电子电脑塑胶五金零件目录

1.LED间隔柱

2.LED导光柱 LED导光盖 LED遮光罩

3.LED座 LED座套 红外线灯罩 光纤座

4.90°LED灯座 45°LED灯座

5.PC板间隔柱 PC板隔离柱

6.塑料铜柱 尼龙柱 六角隔离柱 塑胶铜柱 铜柱 导光板隔离柱 圆体间隔柱 PC板固定定座 固定扣 电路板隔离柱 导电隔离柱

7.排线固定座 自粘式配线固定座 排线固定夹 压线板 电线固定座 扭线固定座 扭式固定环 扎线固定座 电源线固定座 电源线固定座插头固定扣 天线固定座 T8灯管固定座 风扇束线座 光纤固定座

8.PC板端子 接线插片端子 PC板焊接端子 接地片 圆形连接片 弹片 测试针 探针 测试点 保险丝座 保险丝盖 插式电线连接头 闭端端子 弹簧螺纹端子 压线帽 端子台 快速接线夹 跳线

9.仪表脚垫 插销式脚垫 螺丝固定脚垫 脚垫 抗震脚垫 磁铁脚垫 橡胶脚垫 自粘脚垫 银框脚垫 金框脚垫 橡胶垫圈 橡胶华司 橡胶垫片 硅胶脚垫

10.塑料螺丝 塑胶螺丝 翼型塑料螺丝 塑料螺帽 塑料螺帽 蝶形螺母 止付螺丝 紧定螺钉 内牙螺丝 螺丝帽盖 手转螺丝 手拧螺丝 滚花螺丝 手转螺母 手拧螺母

11.PC板拉柄 PC板耳把 PC板导槽 电路板导轨 PCB导轨槽 直立式导槽 电路板导轨

12.晶体管盖 电晶体盖 晶体管垫片 电晶体垫片 晶体管座 电晶体座 T-O3晶体管座 石英晶体垫片 垫圈 华司 垫片 TO-220晶体管座 光电晶体座 电晶体座 IR晶体座 霍尔晶体座 硅胶帽套 功率晶体导热硅片 功率晶体压板 电源固定压条 晶体管固定弹片 五金弹片 电晶体固定弹片 晶体管夹

电子电脑塑胶五金零件目录

13.电容器垫片 垫圈 华司 电容器座 电容器帽套 电容器固定座 电容器盖 电容器护套 压敏护套 硅胶帽套

14.热敏电阻座 电阻保护座 保护电阻器 可变电阻盖

15.陶瓷零件垫片 零件垫片 垫圈 华司 零件垫座 IC座 桥式整流座 跳线座 线圈座 滤波器垫片 绝缘柱 螺丝垫片 滚轮 PC板垫片 球击缓冲垫片 尼龙垫圈 尼龙弹簧垫片 散热陶瓷垫片

16.功率IC盖 桥式整流盖 保护盖 开关盖 硅胶盖 绝缘盖 电池盖 末端套管 软质端子保护套 PC端子保护套 喇叭座 拉柄箱扣 线圈固定座 DRAM固定带 十字型插件式固定器 轨道固定器

17.孔塞 扣式孔塞 扣式塞头 DVI防尘盖 螺丝孔孔塞 螺丝塞头 螺纹孔塞

18.电源线扣 电线固定夹 护线环 橡胶圈 护线圈 开口式护线环 橡胶线环 硅胶线环 硅胶护线环 天线护线环 方型护线环 U型护线环 抗震护线环 防震线环 抗震线环用插销 抗震线环用螺丝 硬盘驱动器防震座 透气压力平衡固定头 透气平衡压力固定扣

19.把手 机箱把手 仪器门拉手 纸箱把手 纸箱配件 打包扣 外箱护脚垫 纸箱外箱扣

20.阻尼齿轮 阻尼器 缓冲齿轮

21.电线扎带 电线束线带 固定带 扎线 电源线收线带 珠型扎带 水管座 扎带座 扎带扣 吊勾 粘扣带 绑线带

22.USB座护盖 USB端口保护盖 USB端口防尘盖 MICRO USB防尘盖 MINI USB座护盖 USB Type-C防尘盖 USB防尘盖 RJ-45防尘盖 RJ-11防尘盖 RJ-12防尘盖 RJ-22防尘盖 电源插头防尘盖 电源插头保护座 电源插头防尘座 电源插头防尘盖 光纤连接器护盖 光纤连接器护套 光纤防尘盖 PC板金手指防尘盖 HDMI防尘盖 Mini数位端子防尘盖 汽车点烟器防尘盖 BBU防尘盖 DVI防尘盖 连接器盖 SIM Card Cap防尘盖 SD防尘盖 KVM防尘盖 CF防尘盖 防尘盖 端子盖 S端子盖 平衡端子盖 BNC绝缘座 SATA防尘盖 ESATA护盖 DP端子防尘盖 Mini D.P数位端子防尘盖 D.Type防尘盖 VGA防尘盖 IDE Connector防尘盖 PC端子防尘盖 端子防尘盖 1394端子防尘盖 零件盖 电源盖 机板电源保护盖 连接器座 PCMIC卡保护盖 面板 DDR防尘盖 D-Sub保护盖 高压防尘盖 SD保护盖 Micoro SD卡保护盖 SIM卡保护盖 防水帽盖 帽盖连接带 防水圈 电脑风扇防护盖 电脑风扇防尘座 电脑风扇框护垫 电脑风扇支架 开关遮板 光纤晶体座

电子电脑塑胶五金零件目录

23.插销 铆钉 尼龙铆钉 螺丝铆钉 散热片铆钉 塑料铆钉 电脑风扇铆钉 散热片扣件 弹簧铆钉
螺丝固定座 膨胀螺栓 墙塞 无帽鱼型膨胀管 墙面固定座 石膏板固定座

24.固定扣 门扣开关 机器门扣开关 弹簧固定座 旋转型门扣 门扣碰珠 磁铁门扣

55.工具 线扣工具 进口束线枪 旗型端子工具 国产束线枪 非绝缘端子工具 绝缘端子工具



电子电脑塑胶五金零件目录



1.LED间隔柱



2.LED导光柱



3.LED座



4.90°LED灯座



5.PC板间隔柱



6.塑料铜柱



7.排线固定座



8.PC板端子



9.仪表脚垫



10.塑料螺丝



11.PC板拉柄导槽



12.晶体管盖



13.电容器垫片



14.热敏电阻座



15.陶瓷零件垫片



16.功率IC盖



电子电脑塑胶五金零件目录



17.孔塞



18.电源线扣



19.机箱把手



20.阻尼齿轮



21.电线扎带



22.USB座护盖

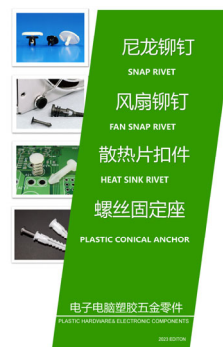

23.尼龙铆钉



24.门扣开关



55.工具



选型手册总目录

本公司保留因质量改进、后续开发或生产要求引起的设计更改权力。本产品目录为元件的详细说明，不能做担保依据。使用者有义务审核该元件是否符合应用范围的规定。



微信



QQ

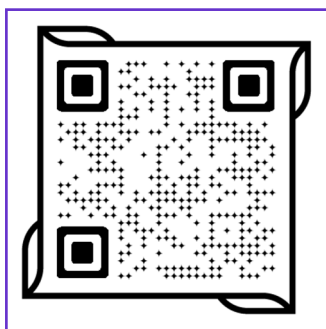

网站

南京诺金电气有限公司

Nanjing Nowking Electric Co., Ltd

- ◆ Tel: 025-85422485 85436028 85437901
- ◆ Wechat/Mobile :13770725488
- ◆ QQ:260678075
- ◆ E-mail: nk@nowking.com
- ◆ [Http://www.nowking.com](http://www.nowking.com)
- ◆ [Http://www.kyphe.com](http://www.kyphe.com)