



电源线扣

STRAIN RELIEF BUSHING



护线环

SNAP BUSHING



橡胶线环

GROMMET

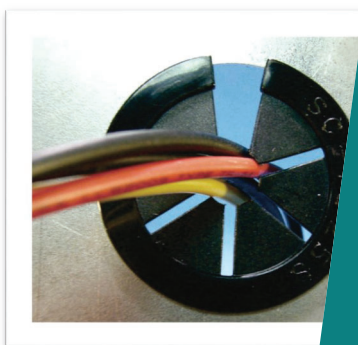

抗震线环

ANTI-VIBRATION GROMMET

电子电脑塑胶五金零件

PLASTIC HARDWARE & ELECTRONIC COMPONENTS

2023 EDITON

电源线扣 电线固定夹 护线环 橡胶圈 护线圈 开口式护线环 橡胶线环 硅胶线环 硅胶护线环 天线护线环 方型护线环 U型护线环 抗震护线环 防震线环 抗震线环用插销 抗震线环用螺丝 硬盘驱动器防震座 透气压力平衡固定头 透气平衡压力固定扣

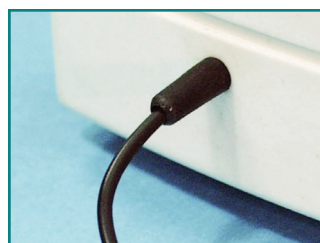
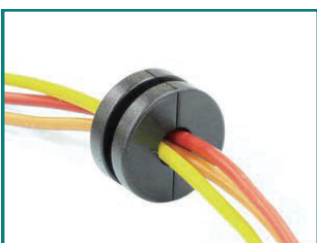
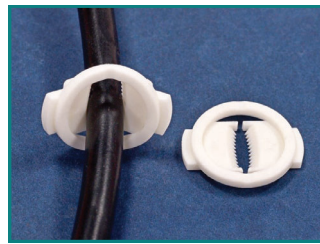
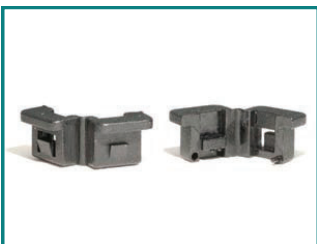
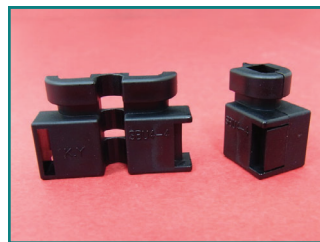
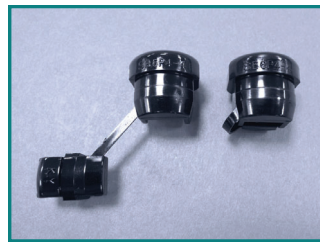
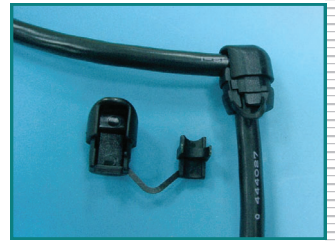
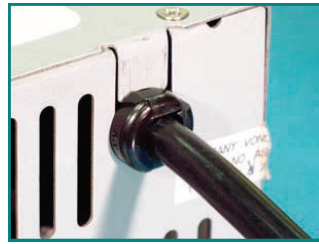
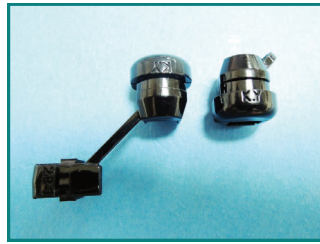
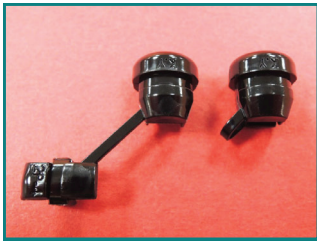

电源线扣 电线固定夹 护线环 橡胶圈 护线圈 开口式护线环 橡胶线环 硅胶线环 硅胶护线环 天线护线环 方型护线环 U型护线环 抗震护线环 防震线环 抗震线环用插销 抗震线环用螺丝 硬盘驱动器防震座 透气压力平衡固定头 透气平衡压力固定扣

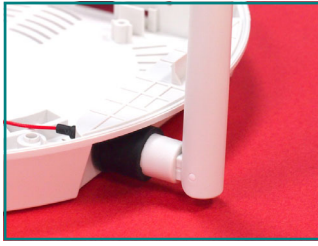
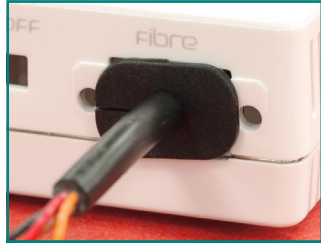
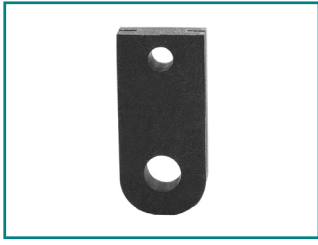
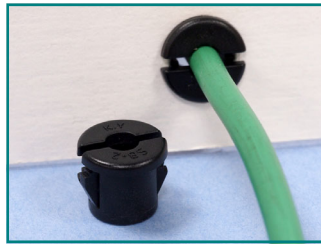
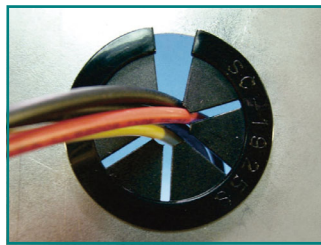
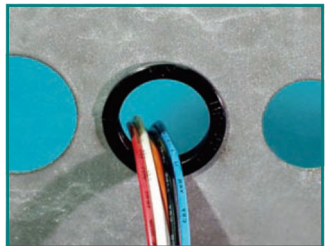
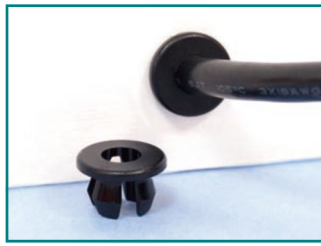
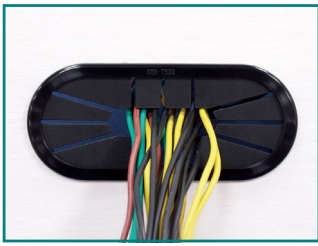

护线环/硅胶线环

电源线扣 电线固定夹 护线环 橡胶圈 护线圈 开口式护线环 橡胶线环 硅胶线环 硅胶护线环 天线护线环 方型护线环 U型护线环 抗震护线环 防震线环 抗震线环用插销 抗震线环用螺丝 硬盘驱动器防震座 透气压力平衡固定头 透气平衡压力固定扣

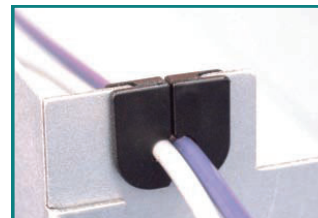
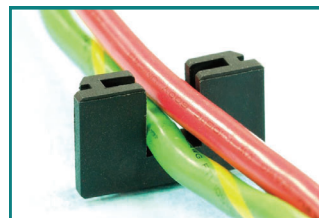
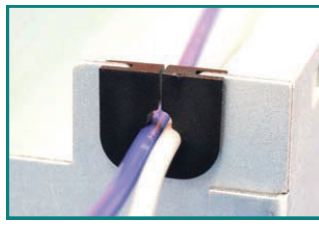
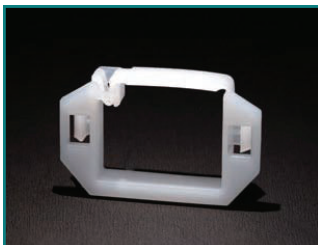
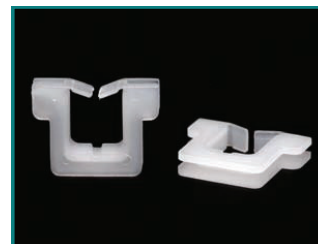
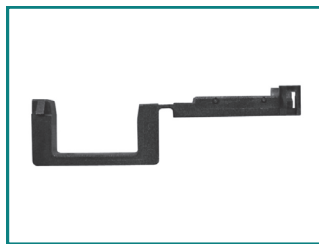
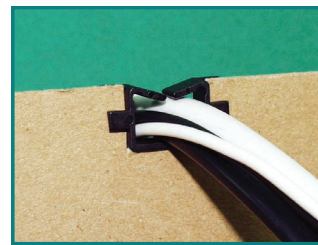
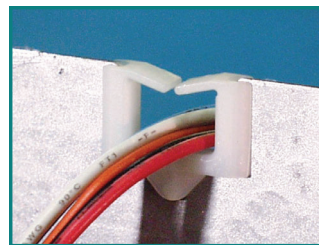
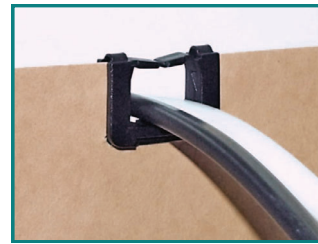
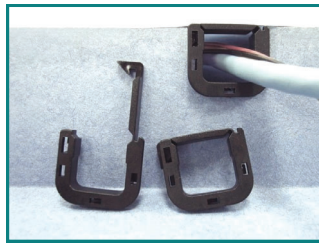

方型护线环

电源线扣 电线固定夹 护线环 橡胶圈 护线圈 开口式护线环 橡胶线环 硅胶线环 硅胶护线环 天线护线环 方型护线环 U型护线环 抗震护线环 防震线环 抗震线环用插销 抗震线环用螺丝 硬盘驱动器防震座 透气压力平衡固定头 透气平衡压力固定扣

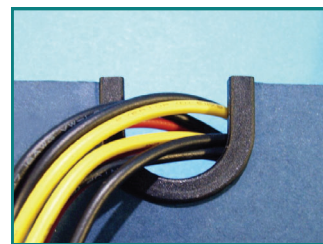
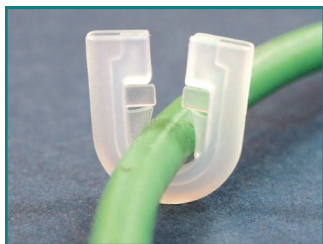
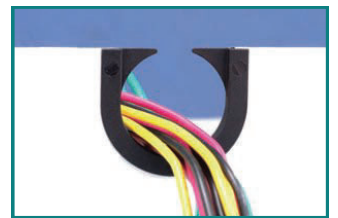
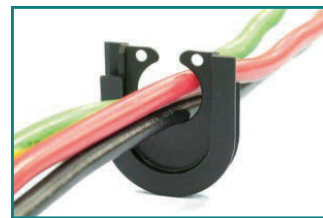
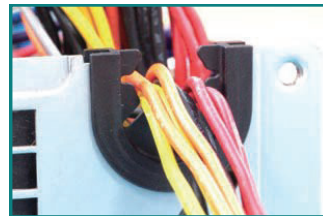
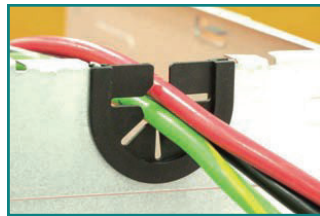
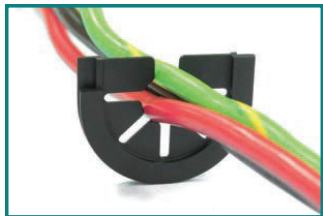
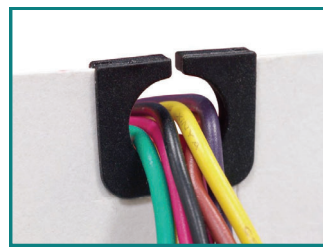
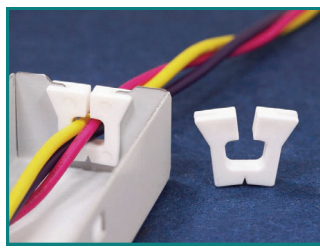
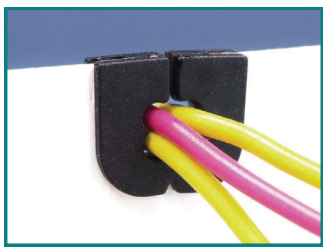

护线环/抗震线环

电源线扣 电线固定夹 护线环 橡胶圈 护线圈 开口式护线环 橡胶线环 硅胶线环 硅胶护线环 天线护线环 方型护线环 U型护线环 抗震护线环 防震线环 抗震线环用插销 抗震线环用螺丝 硬盘驱动器防震座 透气压力平衡固定头 透气平衡压力固定扣

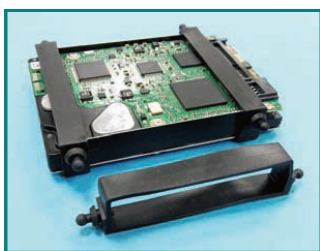

电源线扣 电线固定夹 护线环 橡胶圈 护线圈 开口式护线环 橡胶线环 硅胶线环 硅胶护线环 天线护线环 方型护线环 U型护线环 抗震护线环 防震线环 抗震线环用插销 抗震线环用螺丝 硬盘驱动器防震座 透气压力平衡固定头 透气平衡压力固定扣

电源线扣 STRAIN RELIEF BUSHING



- ◆ MATERIAL : NYLON 66 (UL)
- ◆ FLAME CLASS : 94V-0/94V-2
- ◆ COLOR : BLACK
- ◆ UNIT: mm

用途：电源线扣，用于电子电器电源出线口，固定扣牢和保护电源免于被机壳刮伤，造成短路。

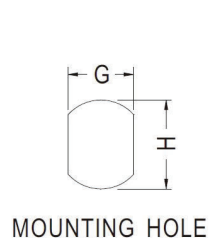
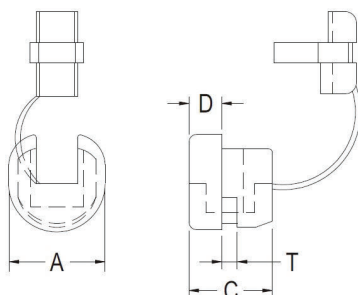

PART NO	WILL FIT THESE CABLE		DIMENSION			CHASSIS DIMENSION		CHASSIS DIMENSION	适用线材断面 形状	PACKAGE
	AWG/ CONDUCTOR	SIZE	A	C	D	G	H	T	SECTION SHAPE	
2P-4	18/2C	3.0X5.6	10.4	10.4	4	8.7	9.5	1.6	扁線用 FLAT TYPE	1000
3P-4	18/2C	3.0X5.6	11.5	10.4	4	9.9	11	1.6		1000
3W-1	18/2C	3.0X5.6	11.5	10.4	4	9.9	11	2.5		1000
4N-4-1	18/2C	3.71X7.6	13.3	10.4	4	11.8	12.7	1.6		1000
4N-4-2	16/2C	3.8X7.6	13.3	10.4	4	11.8	13.1	1.6		1000
4K-4-1	18/2C	3.71X7.6	13.3	10.5	4	11.8	12.7	2.5		1000
4K-4-2	16/2C	3.8X7.6	13.3	10.5	4	11.8	13.1	2.5	1000	
5N-4-1	18/3C	Φ6.4~Φ7.4	13.5	10.9	4.2	11.5	12.7	1.6	圓線用 ROUND TYPE	1000
5N-4-2	18/3C	Φ6.4~Φ7.4	13.5	10.9	4.2	11.5	13.1	1.6		1000
5P-4-1	18/3C	Φ6.4~Φ7.4	13.5	10.9	4.2	11.5	12.7	2.5		1000
5P-4-2	18/3C	Φ6.4~Φ7.4	13.5	10.9	4.2	11.5	13.1	2.5		1000
6N-4	18/3C	Φ7.6	16.8	14.8	5.6	14	15.9	1.6		500
6P-4	18/3C	Φ7.6	16.8	14.8	5.6	14	15.9	3.2		500
6N3-4	16/3C	Φ8.2~Φ9.2	16.2	15	5.6	14	15.9	1.6		500
6P3-4	16/3C	Φ8.2~Φ9.2	16.2	14.8	5.7	14	15.9	3.2		500
7N-2-1	14/3C	Φ9.2~Φ10.5	19.5	19.1	7.8	16.5	19	1.6		100
7N-2-2	14/3C	Φ11.0	19.5	19.1	7.8	16.5	19.8	1.6		100
7P-2-1	14/3C	Φ9.2~Φ10.5	19.5	19.4	7.8	16.5	19	3.2	100	
7P-2-2	14/3C	Φ11.0	19.5	19.4	7.8	16.5	19.8	3.2	100	

电源线扣 STRAIN RELIEF BUSHING

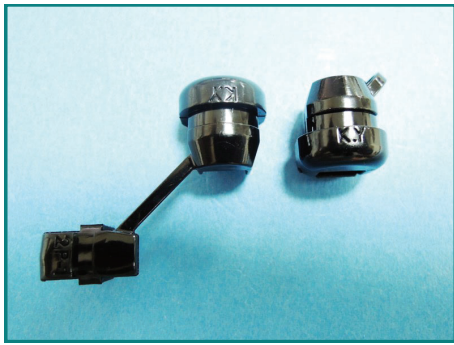

- ◆ MATERIAL : NYLON 66 (UL)
- ◆ FLAME CLASS : 94V-0/94V-2
- ◆ COLOR : BLACK
- ◆ UNIT: mm

用途：电源线扣，用于电子电器电源出线口，固定扣牢和保护电源免于被机壳刮伤，造成短路。

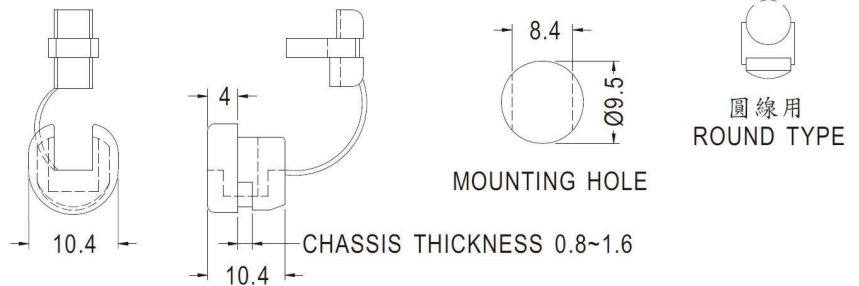

PART NO	WILL FIT THESE CABLE SIZE	适用线材断面形状 SECTION SHAPE	PACKAGE
2P-1	Φ3.0~Φ4.7	圓線用 ROUND TYPE	500

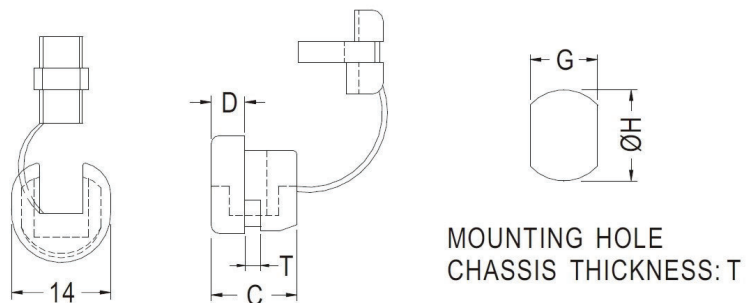

PART NO	WILL FIT THESE CABLE SIZE	DIMENSION		CHASSIS DIMENSION		CHASSIS THICKNESS T	PACKAGE
		C	D	G	H		
SB4F-2	4.1X8.6	12.4	4.0	11.8	12.7	1.8~2.5	500
SB5P-2	Φ6.8~Φ7.8	12.5	4.4	11.8	12.7	0.8~2.6	500
SB5R-2	Φ8.2~Φ9.2	11.5	4.8	11.5	12.7	0.8~1.6	500

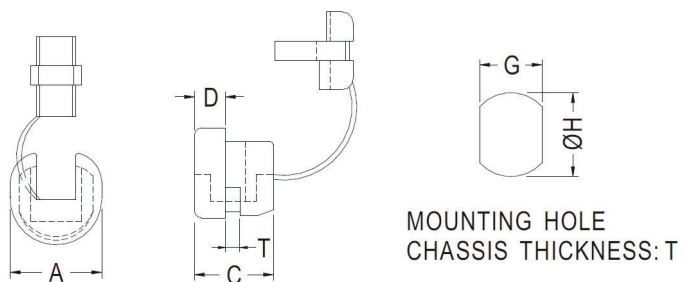

PART NO	WILL FIT THESE CABLE SIZE	DIMENSION			CHASSIS DIMENSION		CHASSIS DIMENSION T	PACKAGE
		A	C	D	G	H		
SB5F-4	5.0X10.0	15.5	15.4	6.2	13.4	14.3	0.8~1.6	250
SB5F-6	5.0X10.0	15.5	15.4	6.2	13.4	14.3	1.8~3.2	250
SB6R-6	Φ8.2~Φ9.2	16.6	14.6	5.6	14	15.9	0.8~1.6	250
SB5R-4-1	Φ8.2~Φ9.2	13.4	10.9	4.2	11.5	13.1	0.8~1.6	500
SB5R-4-2	Φ7.6	13.4	10.9	4.2	11.5	12.7	0.8~1.6	500

电源线扣 STRAIN RELIEF BUSHING



- ◆ MATERIAL : NYLON 66 (UL)
- ◆ FLAME CLASS : 94V-0/94V-2
- ◆ COLOR : BLACK
- ◆ UNIT: mm

用途：电源线扣，用于电子电器电源出线口，固定扣牢和保护电源免于被机壳刮伤，造成短路。

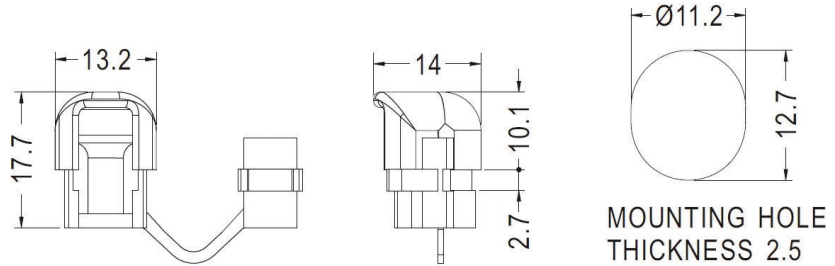

PART NO	WILL FIT THESE CABLE	PACKAGE
	SIZE	
SB4L-4	3.0X6.6	500
SB5L-4	6.0	500

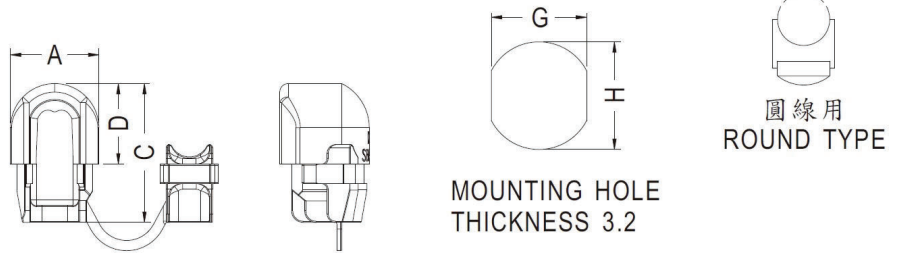

PART NO	WILL FIT THESE CABLE	DIMENSION			CHASSIS DIMENSION		適用线材断面形状 SECTION SHAPE	PACKAGE	
	AWG/ CONDUCTOR	SIZE	A	C	D	G			H
SB6L-6	18/3C	Φ7.4~Φ8.2	15.4	24.5	14.2	14.0	15.9	圓線用 ROUND TYPE	100
SB7L-2	14/3C	Φ9.2~Φ10.5	19.5	27.8	16.3	16.3	19.0		100

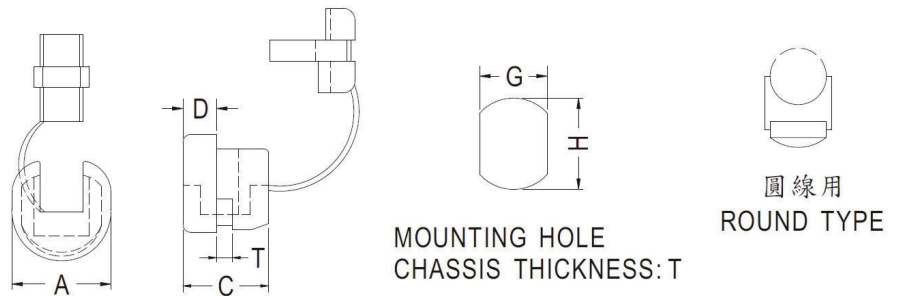

PART NO	WILL FIT THESE CABLE	DIMENSION			CHASSIS DIMENSION	CHASSIS DIMENSION	適用线材断面形状 SECTION SHAPE	PACKAGE		
	AWG/ CONDUCTOR	SIZE	A	C	D	G			H	T
SB8R-2	14/3C	Φ13.5~Φ15.2	22.6	20.4	8.4	21.7	22	1.8~2.5	圓線用 ROUND TYPE	100
SB9R-2-1	10/3C	Φ15.2~Φ16.3	27.5	25.2	10.6	25.4	28	1.2~7.0		100
SB9R-2-2	10/3C	Φ17.5	27.5	25.2	10.6	25.4	30.2	1.2~7.0		100

电源线扣 STRAIN RELIEF BUSHING



- ◆ MATERIAL : NYLON 66 (UL)
- ◆ FLAME CLASS : 94V-0/94V-2
- ◆ COLOR : BLACK/NATURAL/GRAY
- ◆ UNIT: mm

用途：电源线扣，用于电子电器电源出线口，固定扣牢和保护电源免于被机壳刮伤，造成短路。

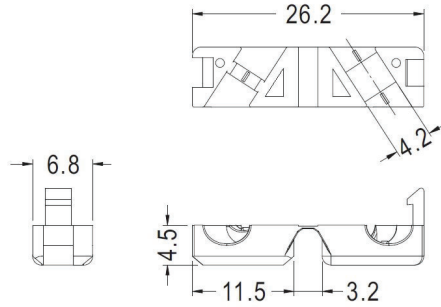

PART NO	PACKAGE
SBQC-1	100



- ◆ MATERIAL : NYLON 66 (UL)
- ◆ FLAME CLASS : 94V-0/94V-2
- ◆ COLOR : BLACK
- ◆ UNIT: mm

用途：电源线扣，用于电子电器电源出线口，固定扣牢和保护电源免于被机壳刮伤，造成短路。

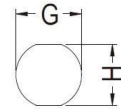
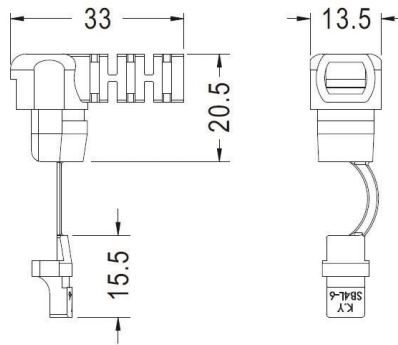

MOUNTING HOLE THICKNESS 1.5~2.0

PART NO	WILL FIT THESE CABLE	CHASSIS DIMENSION		适用线材断面形状 SECTION SHAPE	PACKAGE
	SIZE	G	H		
SB4L-6-1	3.3X6.6	12.7	10.9	扁线用 FLAT TYPE	500
SB4L-6-2	3.6X7.2	13.2	10.9		500

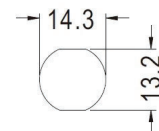
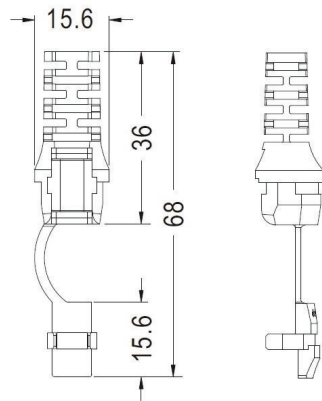

MOUNTING HOLE THICKNESS 0.8~2.3

PART NO	WILL FIT THESE CABLE	适用线材断面形状 SECTION SHAPE	PACKAGE
	SIZE		
SB4F-9	4.6X8	扁线用 FLAT TYPE	500

电源线扣 STRAIN RELIEF BUSHING



- ◆ MATERIAL : NYLON 66 (UL)
- ◆ FLAME CLASS : 94V-0/94V-2
- ◆ COLOR : BLACK
- ◆ UNIT: mm

用途：电源线扣，用于电子电器电源出线口，固定扣牢和保护电源免于被机壳刮伤，造成短路。

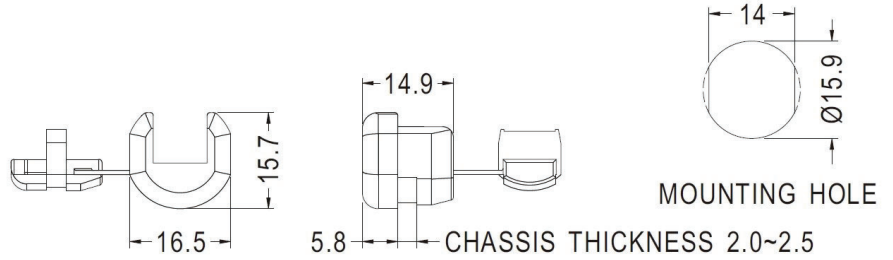

PART NO	WILL FIT THESE CABLE		PACKAGE
	AWG/CONDUCTOR	SIZE	
SB6P4-4-1	18/3	3.0X7.6	500
SB6P4-4-2	16/3	4.1X10.4	500

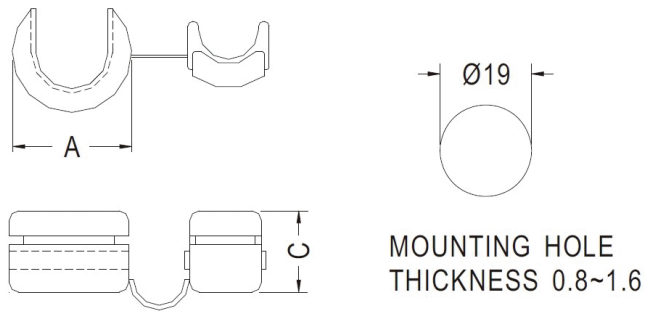
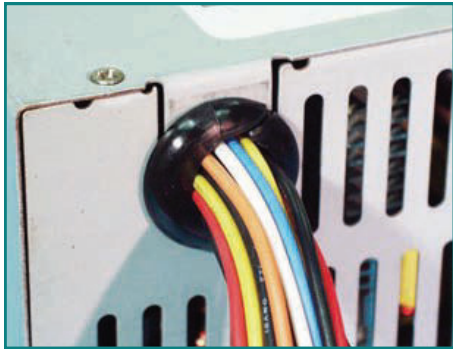

PART NO	WILL FIT THESE CABLE SIZE	DIMENSION		PACKAGE
		A	C	
SB7R-7	14.0~17.0	25.0	17.0	100
SB7R-7SP	12.0~15.2	25.3	17.8	100

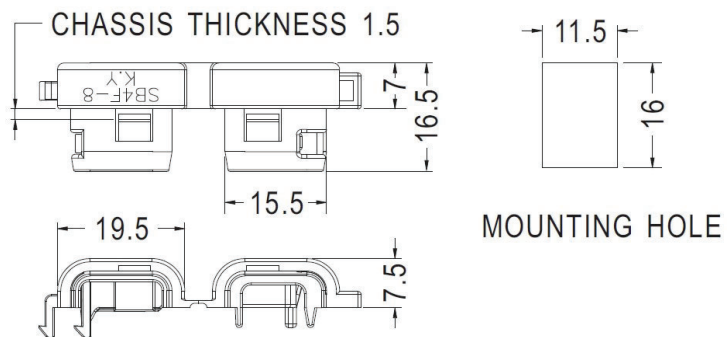

PART NO	WILL FIT THESE CABLE		PACKAGE
	SIZE		
SB4F-8	3X5.6 / 3.71X7.6		200

电源线扣 STRAIN RELIEF BUSHING

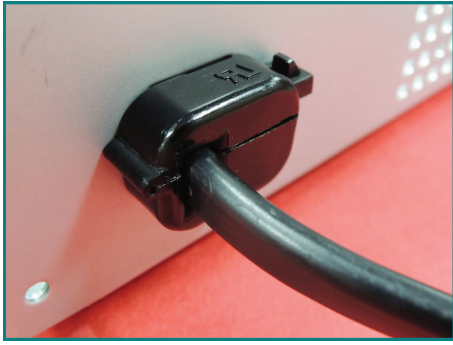

- ◆ MATERIAL : NYLON 66 (UL)
- ◆ FLAME CLASS : 94V-0/94V-2
- ◆ COLOR : BLACK
- ◆ UNIT: mm

用途：电源线扣，用于电子电器电源出线口，固定扣牢和保护电源免于被机壳刮伤，造成短路。

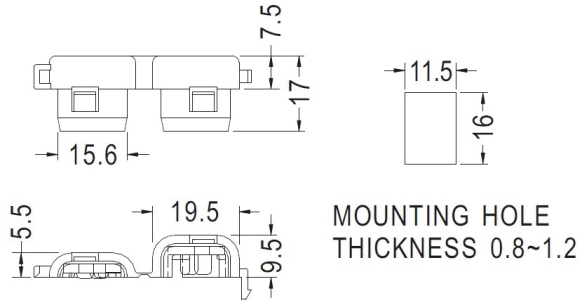

PART NO	WILL FIT THESE CABLE	PACKAGE
	SIZE	
SB4F-6	3X5.6 / 3.74X7.6	200

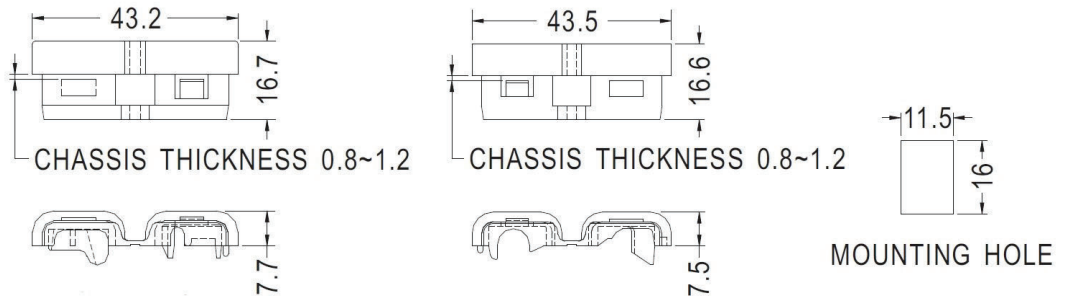

PART NO	WILL FIT THESE CABLE	PACKAGE
	SIZE	
SB4F-4	3X5.6 / 3.74X7.6	250

PART NO	WILL FIT THESE CABLE	PACKAGE
	SIZE	
SB4F-5	Φ6.6~Φ7.2	250

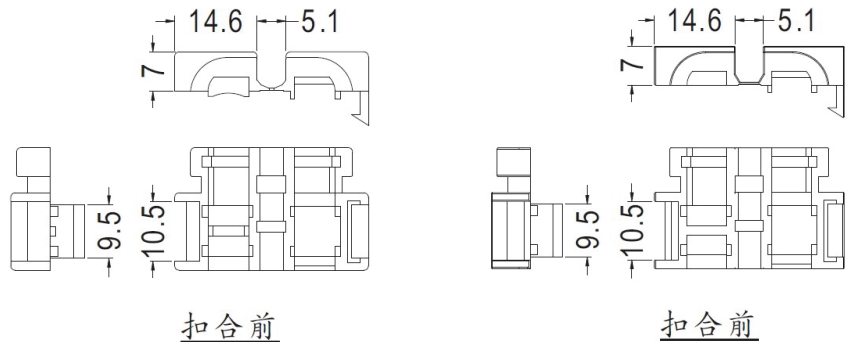
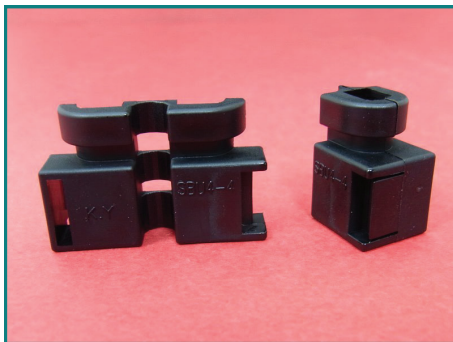

PART NO	PACKAGE
SBU4-4	1000

PART NO	PACKAGE
SBU4-4-1	1000

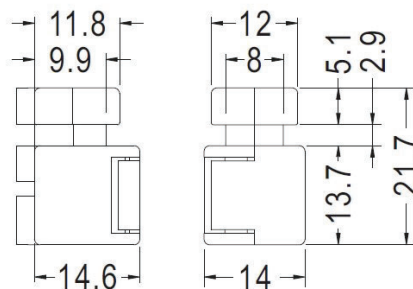

扣合後

电源线扣 STRAIN RELIEF BUSHING



- ◆ MATERIAL : NYLON 66 (UL)
- ◆ FLAME CLASS : 94V-0/94V-2
- ◆ COLOR : BLACK
- ◆ UNIT: mm

用途：电源线扣，用于电子电器电源出线口，固定扣牢和保护电源免于被机壳刮伤，造成短路。

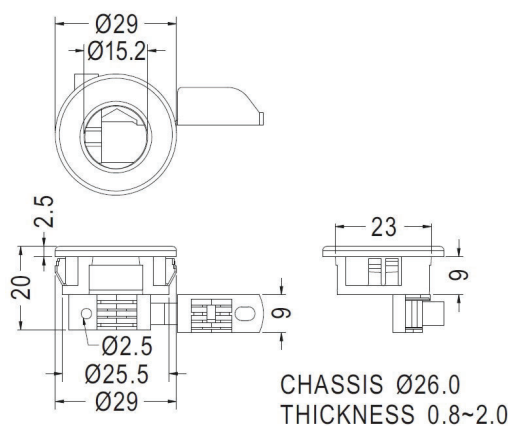

PART NO	PACKAGE
SBB-1	1000

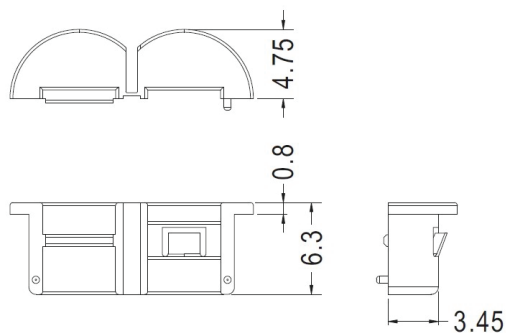

CHASSIS Ø7.0
THICKNESS 0.6~1.1

PART NO	PACKAGE
SBU-1	1000

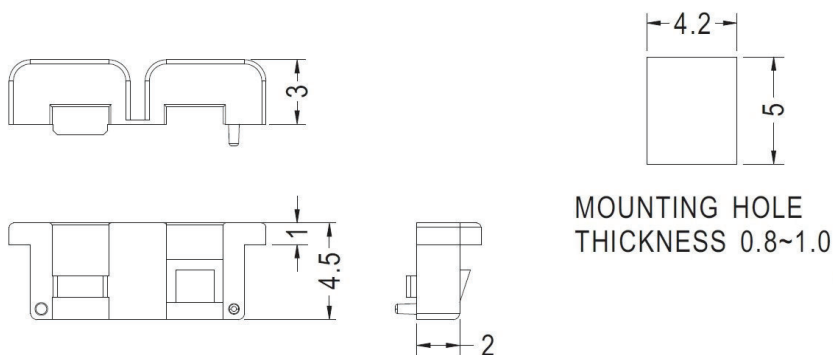

PART NO	PACKAGE
SBU-2	1000

电线固定夹 WIRE CLIP

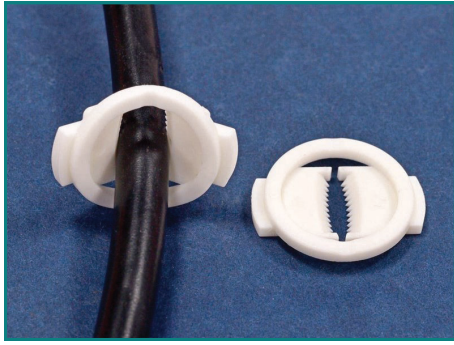

- ◆ MATERIAL : NYLON 66 (UL)
- ◆ FLAME CLASS : 94V-0/94V-2
- ◆ COLOR : BLACK/NATURAL
- ◆ UNIT: mm

用途： 电线固定夹，用于机壳的出线口，避免电源线被拉出。

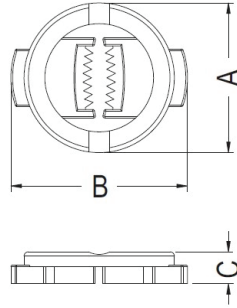

PART NO	A	B	C	SUGGESTED CABLE DIAMETER RANGE	PACKAGE
KWL-28	17.7	20.8	3.75	Φ7.0	1000
KWL-29	22.2	25.5	4.0	Φ9.0	1000

护线环 SNAP BUSHING 橡胶圈 护线圈



- ◆ MATERIAL : NYLON 66 (UL)
- ◆ FLAME CLASS : 94V-0/94V-2
- ◆ COLOR : BLACK
- ◆ UNIT: mm

用途：护线环，用于机壳的电线出线口，保护电线不受机壳刮伤，装配容易。

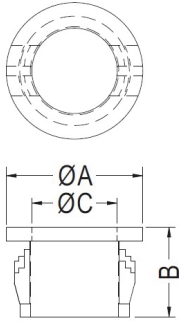

MOUNTING HOLE: ØG
THICKNESS: T

PART NO	A	B	C	G	T	PACKAGE
312-3	9.5	8.2	5.2	8.0	0.8~1.8	1000
375-4	12.0	10.3	6.6	9.5	0.8~3.3	1000
0811	13.6	10.3	8.4	11.1	0.8~3.3	1000
0813	15.1	10.3	9.8	12.7	0.8~3.3	1000
1216	18.2	10.3	12.8	16.0	0.8~3.3	1000

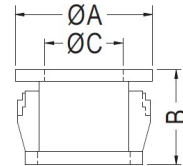
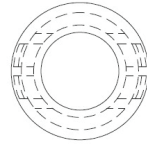

MOUNTING HOLE: ØG
THICKNESS: T

PART NO	A	B	C	G	T	PACKAGE
NB-1419	21.5	11.3	14.3	19.0	0.8~3.3	200
NB-1217	20.0	10.3	12.7	17.5	0.8~3.3	200
NB-1722	25.1	11.2	18.6	22.2	0.8~3.3	100
NB-1922	23.8	6.3	19.0	22.2	0.8~1.6	100
NB-1925	28.0	10.8	19.4	25.4	0.8~3.3	100
NB-2428	31.5	11.3	24.1	28.0	1.0~3.3	200
NB-2430	34.0	11.7	24.5	30.1	0.8~3.3	200
NB-2535	37.8	11.3	25.8	35.0	0.8~3.5	200
NB-2634	38.0	11.5	26.2	34.2	1.0~3.1	200
NB-2935	37.8	11.3	29.7	35.0	0.8~3.5	200
NB-3034	38.0	11.5	30.4	34.2	1.0~3.1	200
NB-3338	41.2	11.6	33.3	38.0	1.0~3.3	200
NB-4150	53.8	11.4	41.8	50.8	0.8~3.2	100
NB-4450	53.8	11.4	44.3	50.8	0.8~3.2	100
NB-4757	63.0	18.1	47.3	57.1	6.35	100
NB-5063	67.5	18.1	50.5	63.5	6.35	100
NB-5563	67.5	18.1	55.5	63.5	6.35	100
NB-0710	12.1	6.6	7.2	10.0	0.8~1.8	1000

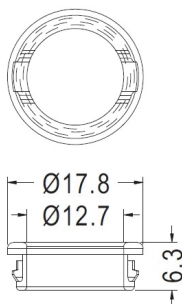

MOUNTING HOLE Ø15.8
THICKNESS 0.8~1.6

PART NO	PACKAGE
NB-1215	1000

护线环 SNAP BUSHING 橡胶圈 护线圈



- ◆ MATERIAL : NYLON 66 (UL)
- ◆ FLAME CLASS : 94V-0/94V-2
- ◆ COLOR : BLACK
- ◆ UNIT: mm

用途：护线环，用于机壳的电线出线口，保护电线不受机壳刮伤，装配容易。

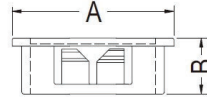
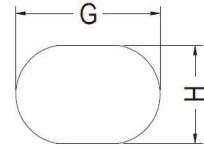
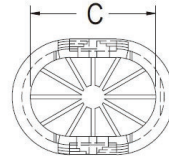

MOUNTING HOLE THICKNESS: T

PART NO	A	B	C	G	H	T	PACKAGE
NBR-3025	34.0	6.5	26.7	30.5	25.0	0.8~1.5	1000
NBR-3725	41.5	14.3	32.2	37.0	25.0	1.2~3.0	500
NBR-5030	54.2	14.3	44.9	50.0	30.0	1.2~3.0	100
NBR-5030S	54.2	7.5	44.9	50.0	30.0	0.8~1.6	100
NBR-8054	84.5	14.3	71.4	80.0	54.0	1.2~3.0	50

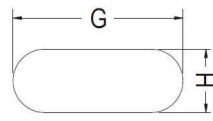
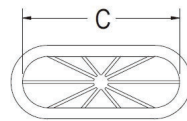

MOUNTING HOLE THICKNESS: T

PART NO	A	B	C	G	H	T	PACKAGE
NBR-7026	74.2	14.3	64.7	70.0	26.0	1.2~3.2	100
NBR-5520	59.2	14.3	49.9	55.0	20.0	1.2~3.2	100

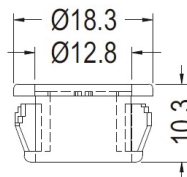
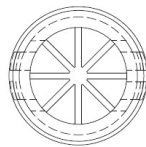

MOUNTING HOLE Ø15.9
THICKNESS 3.2

PART NO	PACKAGE
SC-1216	1000

护线环 SNAP BUSHING 橡胶圈 护线圈



- ◆ MATERIAL : NYLON 66 (UL)
- ◆ FLAME CLASS : 94V-0/94V-2
- ◆ COLOR : BLACK
- ◆ UNIT: mm

用途：护线环，用于机壳的电线出线口，保护电线不受机壳刮伤，装配容易。

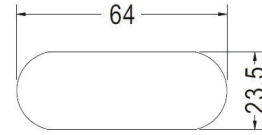
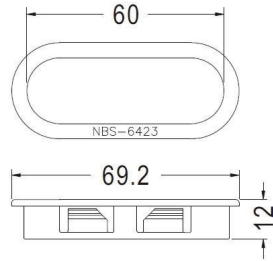

MOUNTING HOLE THICKNESS 0.8~2.5

PART NO	PACKAGE
NBS-6423	100

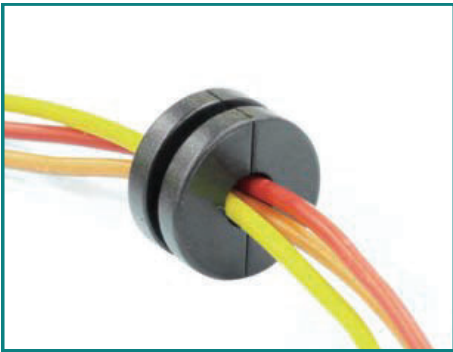

- ◆ MATERIAL : PC+ABS (UL)
- ◆ FLAME CLASS : 94V-0/94V-2
- ◆ COLOR : BLACK
- ◆ UNIT: mm

用途：护线环，用于电线、电缆之固定及保护。

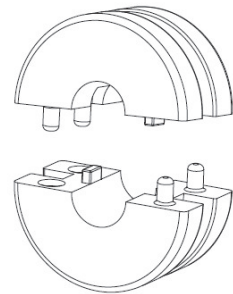
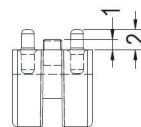
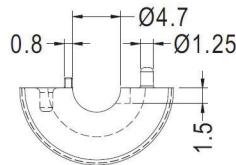
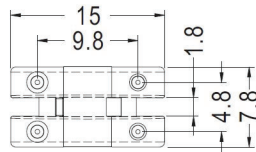

PART NO	PACKAGE
SBUT-1	1000



- ◆ MATERIAL : PC+ABS (UL)
- ◆ FLAME CLASS : 94V-0/94V-2
- ◆ COLOR : BLACK
- ◆ UNIT: mm

用途：护线环，用于电线、电缆之固定及保护。

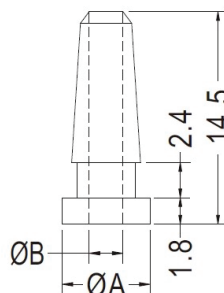

MOUNTING HOLE: ØG

PART NO	A	B	G	PACKAGE
LGT-2	6.0	2.3	4.0	1000
LGT-6G	7.0	3.0	4.8	1000

护线环 SNAP BUSHING 橡胶圈 护线圈

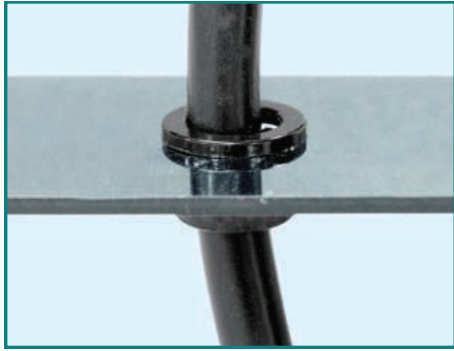

- ◆ MATERIAL : NYLON 66 (UL)
- ◆ FLAME CLASS : 94V-0/94V-2
- ◆ COLOR : BLACK / NATURAL
- ◆ UNIT: mm

用途：护线环，用于机壳的电线出线口，保护电线不受机壳刮伤，装配容易。

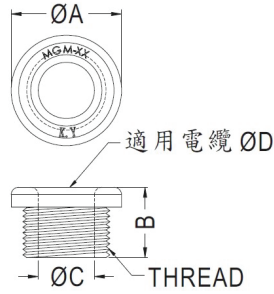

MOUNTING HOLE: ØG

PART NO	A	B	C	D	G	THREAD	搭配螺帽	PACKAGE
MGM-12	18.0	12.0	8.8	8.5	12.0~12.5	M12X1.5P	KGB12-07A	500
MGM-16	21.7	13.5	11.2	11.0	16.0~16.5	M16X1.5P	KGB16-07A	500
MGM-20	26.8	13.5	15.2	15.0	20.0~20.5	M20X1.5P	KGB20-14A	100
MGM-25	32.6	14.0	19.2	19.0	25.0~25.5	M25X1.5P	KGB25-16A	100
MGM-32	42.0	19.0	26.2	26.0	32.0~32.5	M32X1.5P	KGB32-25A	100
MGM-10	15.0	12.0	7.0	6.5	10.0~10.5	M10X1.5P	M-10N	500



- ◆ COLOR : BLACK

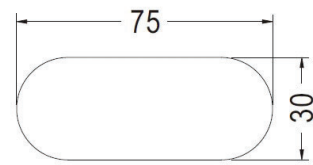
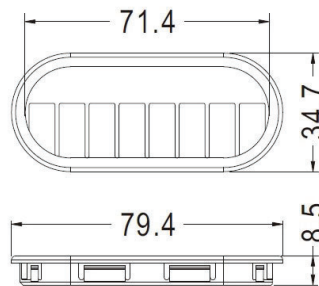

MOUNTING HOLE THICKNESS 1.2

PART NO	PACKAGE
NBR-7530-2	100

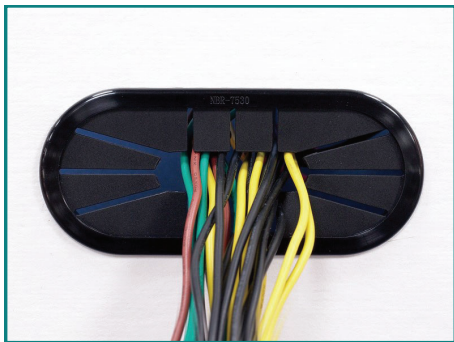

- ◆ COLOR : BLACK

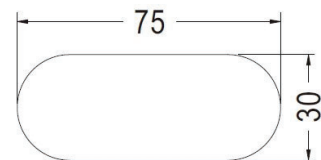
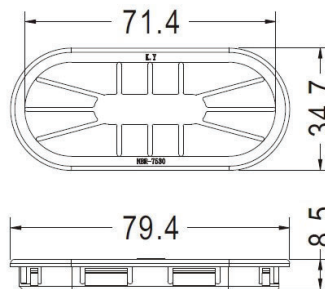

MOUNTING HOLE THICKNESS 1.2

PART NO	PACKAGE
NBR-7530	100

护线环 SNAP BUSHING 橡胶圈 护线圈



- ◆ MATERIAL : NYLON 66 (UL)
- ◆ FLAME CLASS : 94V-0/94V-2
- ◆ COLOR : BLACK/NATURAL
- ◆ UNIT: mm

用途： 开口式护线环，用于机壳的电线出线口，保护电线不受机壳刮伤，装配容易。

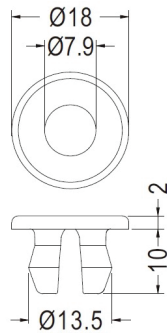

MOUNTING HOLE Ø12.0
THICKNESS 4.6

PART NO	PACKAGE
SBA-1	1000

开口式护线环 SNAP BUSHING 橡胶圈 护线圈



- ◆ MATERIAL : NYLON 66 (UL)
- ◆ FLAME CLASS : 94V-0/94V-2
- ◆ COLOR : BLACK
- ◆ UNIT: mm
- ◆ 採開口式量法

用途： 开口式护线环，用于机壳的电线出线口，保护电线不受机壳刮伤，装配容易。

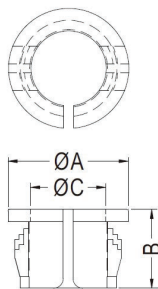

MOUNTING HOLE: ØG
THICKNESS: T

PART NO	A	B	C	G	T	PACKAGE
0813C	15.0	9.8	9.7	12.7	0.8~3.3	1000
1216C	18.4	10.4	12.8	15.9	0.8~3.3	1000
1419C	20.7	10.4	15.1	19.0	0.8~3.3	1000
0609C	11.9	6.5	7.3	9.5	0.6~1.6	1000

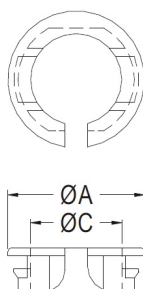
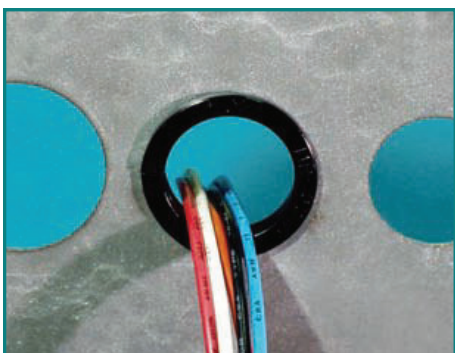

MOUNTING HOLE: ØG
THICKNESS: T

PART NO	A	B	C	G	T	PACKAGE
NB-07A	10.4	4.8	6.0	7.0	0.8~1.0	1000
NB-12A	16.2	5.2	10.8	12.7	0.8~1.0	1000
NB-16A	19.3	5.2	13.0	16.0	0.8~1.0	500
NB-19A	23.0	5.5	15.6	19.0	0.8~1.0	500
NB-21A	25.0	5.6	19.0	21.0	0.8~1.0	500
NB-22A	25.8	5.5	19.5	22.0	0.8~1.0	500
NB-23A	26.4	5.5	20.4	23.0	0.8~1.0	500
NB-24A	27.0	5.3	20.8	24.0	0.8~1.0	500
NB-27A	34.6	6.0	27.0	27.0	0.8~1.0	500
NB-29A	34.0	7.0	26.3	29.0	0.8~1.0	500
NB-30A	36.25	7.0	28.0	30.0	0.8~1.0	500
NB-32A	36.9	6.7	30.0	32.0	0.8~1.2	500

开口式护线环 SNAP BUSHING 橡胶圈 护线圈



- ◆ MATERIAL : NYLON 66 (UL)
- ◆ FLAME CLASS : 94V-0/94V-2
- ◆ COLOR : BLACK
- ◆ UNIT: mm
- ◆ 採開口式量法

用途： 开口式护线环，用于机壳的电线出线口，保护电线不受机壳刮伤，装配容易。

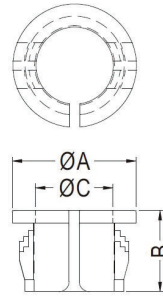

MOUNTING HOLE: ØG
THICKNESS: T

PART NO	A	B	C	G	T	PACKAGE
NB-09	12.4	6.0	7.6	9.5	0.8~1.2	1000
NB-12	16.8	7.3	10.8	12.7	0.8~1.2	1000
NB-16	20.3	7.3	14.1	15.9	0.8~1.0	500
NB-19	22.5	7.3	16.5	19.0	0.8~1.0	500
NB-22	26.0	7.3	20.0	22.0	0.8~1.0	500
NB-25	28.6	7.9	22.0	25.4	0.8~1.6	500

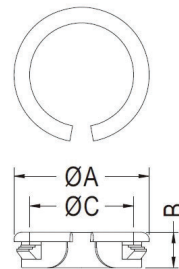

MOUNTING HOLE: ØG
THICKNESS: T

PART NO	A	B	C	G	T	PACKAGE
NB-22T	26.4	5.5	20.3	22.0	0.6~0.8	500
NB-25T	30.3	8.0	23.3	25.4	0.6~1.6	500
NB-25TS	30.3	8.0	23.3	25.0	0.6~1.6	500

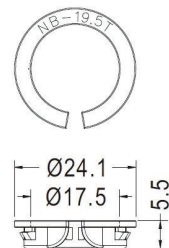

MOUNTING HOLE Ø19.5
THICKNESS 0.6

PART NO	PACKAGE
NB-19.5T	500

开口式护线环 SNAP BUSHING 橡胶圈 护线圈



- ◆ MATERIAL : NYLON 66 (UL)
- ◆ FLAME CLASS : 94V-0/94V-2
- ◆ COLOR : BLACK
- ◆ UNIT: mm
- ◆ 採開口式量法

用途： 开口式护线环，用于机壳的电线出线口，保护电线不受机壳刮伤，装配容易。

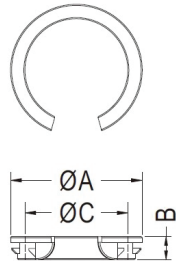

MOUNTING HOLE: ØG
THICKNESS 0.8~1.2

PART NO	A	B	C	G	PACKAGE
NB-27C	34.6	6.0	27.0	27.0	500
NB-29C	34.6	7.0	27.0	29.0	500
NB-32C	36.9	6.7	30.0	32.0	500

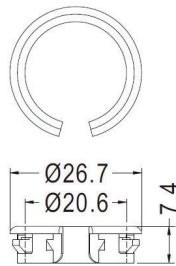

MOUNTING HOLE Ø22.0
THICKNESS 0.8~1.0

PART NO	PACKAGE
NB-22U	500

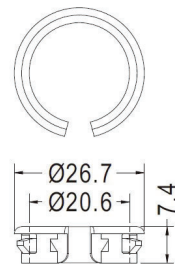

MOUNTING HOLE Ø22.0
THICKNESS 0.6~0.8

PART NO	PACKAGE
NB-22J	500



- ◆ MATERIAL : NYLON 66 (UL)/POM
- ◆ FLAME CLASS : 94V-0/94V-2/94HB
- ◆ COLOR : BLACK/NATURAL
- ◆ UNIT: mm
- ◆ 採開口式量法

用途： 开口式护线环，用于机壳的电线出线口，保护电线不受机壳刮伤，装配容易。

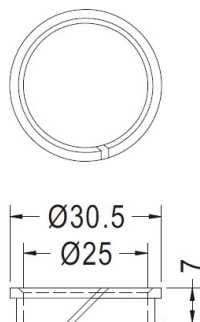

MOUNTING HOLE Ø28.0

PART NO	PACKAGE
NC-28A	500

开口式护线环 SNAP BUSHING 橡胶圈 护线圈



- ◆ MATERIAL : NYLON 66 (UL)
- ◆ FLAME CLASS : 94V-0/94V-2
- ◆ COLOR : NATURAL
- ◆ UNIT: mm
- ◆ 採開口式量法

用途: 开口式护线环, 用于机壳的电线出线口, 保护电线不受机壳刮伤, 装配容易。

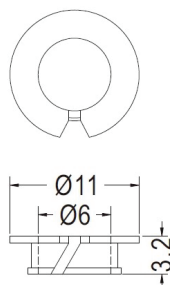

MOUNTING HOLE Ø7.25
THICKNESS 1.1

PART NO	PACKAGE
NC-7	1000

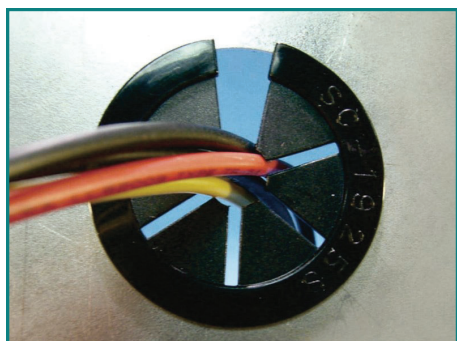

- ◆ MATERIAL : NYLON 66 (UL)
- ◆ FLAME CLASS : 94V-0/94V-2
- ◆ COLOR : BLACK
- ◆ UNIT: mm
- ◆ 採開口式量法

用途: 开口式护线环, 用于机壳的电线出线口, 保护电线不受机壳刮伤, 装配容易。

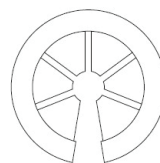

MOUNTING HOLE: ØG
THICKNESS: T

PART NO	A	B	C	G	T	PACKAGE
SC-1925S	29.0	5.3	21.0	25.4	0.8~1.0	250
SC-1925A	29.0	11.4	21.0	25.4	0.8~3.0	250
SC-1319A	22.6	9.75	15.3	19.0	0.8~3.2	500



- ◆ MATERIAL : POM (UL)
- ◆ FLAME CLASS : 94HB
- ◆ COLOR : NATURAL
- ◆ UNIT: mm

用途: 线环, 用于电线之绝缘。

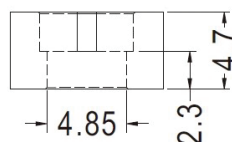
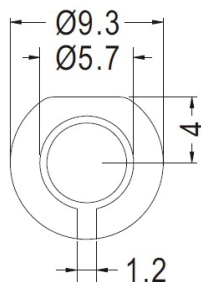

PART NO	PACKAGE
LTRMH-3	1000

开口式护线环 SNAP BUSHING 橡胶圈 护线圈



- ◆ MATERIAL : NYLON 66 (UL)
- ◆ FLAME CLASS : 94V-0/94V-2
- ◆ COLOR : BLACK
- ◆ UNIT: mm
- ◆ 採開口式量法

用途： 开口式护线环，用于机壳的电线出线口，保护电线不受机壳刮伤，装配容易。

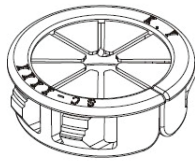

CLOSE

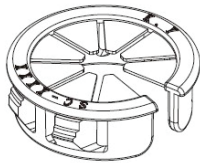

OPEN

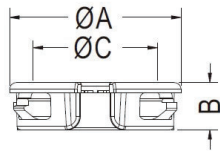
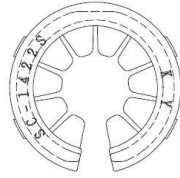

MOUNTING HOLE: ØG
THICKNESS: T

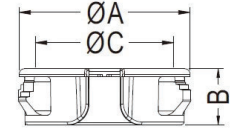
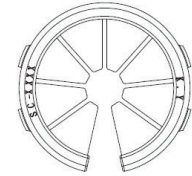

MOUNTING HOLE: ØG
THICKNESS: T

SC-1422S SC-1421S

PART NO	A	B	C	G	T	PACKAGE
SC-1422S	25.5	7.0	18.5	22.2	0.6~1.2	250
SC-0712	15.3	9.8	10.3	12.7	0.8~3.3	1000
SC-1115	18.8	10.3	13.8	15.9	0.8~3.3	1000
SC-1422	25.5	10.3	18.5	22.2	0.8~3.3	250
SC-2027	31.5	10.3	25.5	27.8	0.8~3.3	200
SC-2331	38.7	10.3	29.3	31.8	0.8~3.3	200
SC-2534	39.2	10.3	31.2	34.9	0.8~3.3	200
SC-2638	42.6	10.7	32.6	38.1	0.8~3.3	200
SC-1421S	24.5	8.9	17.85	21.0	0.6~1.6	250

开口式护线环 SNAP BUSHING 橡胶圈 护线圈

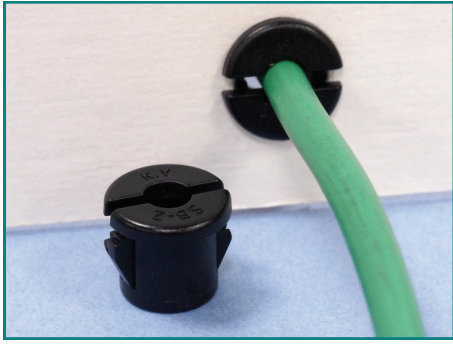

- ◆ MATERIAL : NYLON 66 (UL)
- ◆ FLAME CLASS : 94V-0/94V-2
- ◆ COLOR : NATURAL/BLACK
- ◆ UNIT: mm

用途：开口式护线环，用于机壳的电线出线口，保护电线不受机壳刮伤，装配容易。

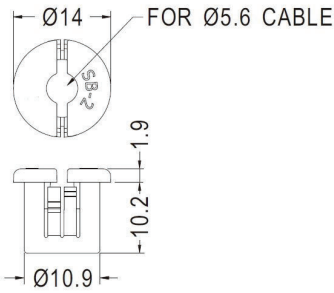

MOUNTING HOLE Ø11.1
THICKNESS 0.6~3.2

PART NO	PACKAGE
SB-2	1000

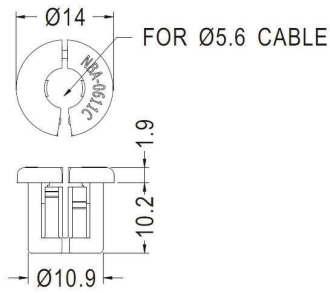

MOUNTING HOLE Ø11.1
THICKNESS 0.6~3.2

PART NO	PACKAGE
NBA-0611C	1000

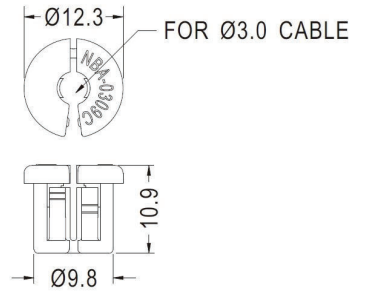

MOUNTING HOLE Ø9.5
THICKNESS 0.6~3.2

PART NO	PACKAGE
NBA-0309C	1000

橡胶线环 GROMMET 橡胶圈 护线圈



- ◆ MATERIAL : RUBBER/SILICON BURBBER
- ◆ COLOR : BLACK
- ◆ UNIT: mm

用途：橡胶线环，用于机壳的电线出线口，保护电线不受机壳刮伤，装配容易。

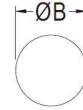
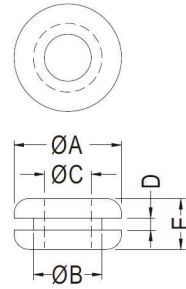

MOUNTING HOLE

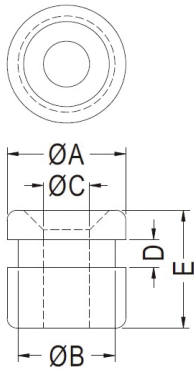

PART NO	A	B	C	D	E	PACKAGE
RUPS-5	8.0	4.8	3.2	1.6	6.4	2000
RUPS-6	9.5	6.4	4.0	1.6	6.4	2000
RUPS-7	10.8	8.0	4.5	1.6	4.5	1000
RUPS-8	14.4	9.5	6.3	1.6	7.0	1000
RUPS-9	14.2	11.0	8.0	1.6	4.8	1000
RUPS-10	17.5	12.7	9.5	1.6	6.8	1000
RUPS-11	22.0	17.5	14.2	1.6	4.8	1000
RUPS-12	22.0	19.0	16.0	1.6	5.5	500
RUPS-13	25.0	19.5	18.0	1.6	6.0	500
RUPS-14	31.4	25.2	18.5	1.6	8.0	250
RUPS-15	19.5	14.0	6.0	1.0	7.0	1000
RUPS-16	15.9	12.7	9.5	1.6	6.4	1000
RUPS-17	7.9	4.8	3.2	1.6	4.8	2000
RUPS-18	17.46	11.11	7.94	2.38	8.73	500
RUPS-19	10.8	8.0	5.0	1.6	4.5	2000
RUPS-20	13.0	8.4	5.5	3.3	6.3	1000
RUPS-21	13.3	9.0	5.8	2.0	6.2	1000

PART NO	A	B	C	D	E	PACKAGE
RUPS-33	18.0	14.7	7.0	4.2	18.0	250

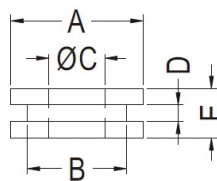
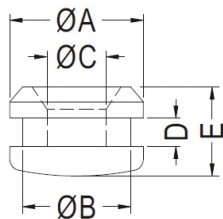
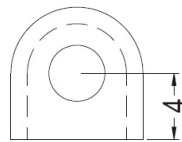
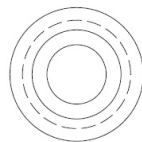

PART NO	A	B	C	D	E	PACKAGE
RUPS-34	18.0	14.6	8.0	3.8	12.0	500

PART NO	A	B	C	D	E	PACKAGE
RUPS-35	8.0	6.0	3.4	1.0	3.0	1000

橡胶线环 GROMMET 橡胶圈 护线圈



- ◆ MATERIAL : RUBBER/SILICON BURBBER
- ◆ COLOR : BLACK
- ◆ UNIT: mm

用途：橡胶线环，用于机壳的电线出线口，保护电线不受机壳刮伤，装配容易。

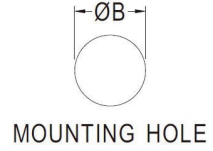
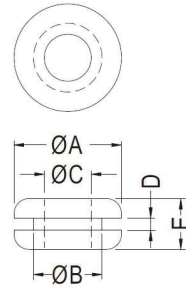
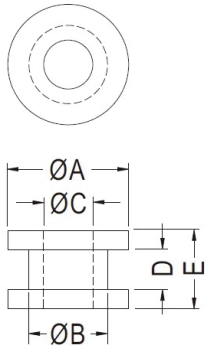

PART NO	A	B	C	D	E	PACKAGE
RUPS-36	24.0	17.5	14.0	3.0	7.0	500
RUPS-37	12.3	8.0	5.0	4.0	8.0	1000
RUPS-38	7.0	6.0	3.5	1.0	5.0	1000
RUPS-39	7.0	6.0	3.5	1.0	3.0	2000
RUPS-40	24.0	18.0	14.0	3.0	7.0	1000

PART NO	A	B	C	D	E	PACKAGE
RUPS-22	27.0	20.8	12.7	1.6	7.8	250
RUPS-23	11.0	7.9	4.7	1.6	6.0	1000
RUPS-24	17.5	13.5	10.0	2.0	7.0	1000
RUPS-25	10.8	8.0	4.5	1.2	4.5	1000
RUPS-26	17.5	12.0	10.0	2.0	6.8	1000
RUPS-27	12.0	9.0	6.5	1.5	5.5	1000
RUPS-28	7.7	5.0	3.1	1.3	2.8	2000
RUPS-29	8.8	6.0	4.1	2.5	7.0	2000
RUPS-30	11.0	9.0	6.0	2.5	6.6	2000
RUPS-31	17.5	12.7	9.0	1.6	6.8	1000
RUPS-32	17.5	12.7	8.6	1.6	6.8	1000
RUPS-80	13.5	9.5	6.3	1.6	7.0	1000

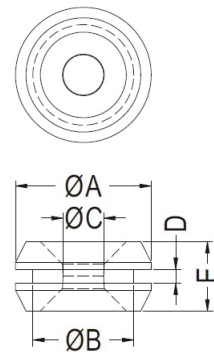
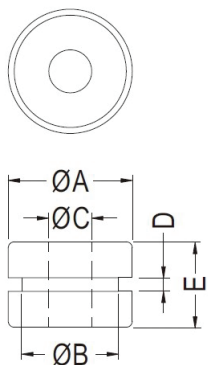

PART NO	A	B	C	D	E	PACKAGE
RUPS-41	10.4	8.1	3.6	1.15	7.15	1000
RUPS-42	7.5	6.0	3.5	1.0	5.0	1000

PART NO	A	B	C	D	E	PACKAGE
RUPS-43	7.8	5.8	2.33	0.8	4.0	1000

橡胶线环 GROMMET 橡胶圈 护线圈



- ◆ MATERIAL : RUBBER/SILICON BURBBER
- ◆ COLOR : BLACK
- ◆ UNIT: mm

用途：橡胶线环，用于机壳的电线出线口，保护电线不受机壳刮伤，装配容易。

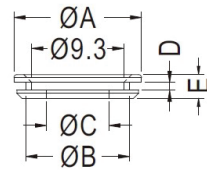
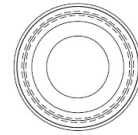
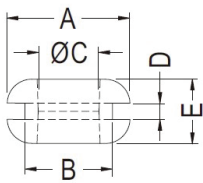
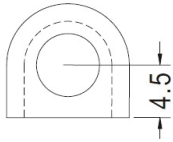

PART NO	A	B	C	D	E	PACKAGE
RUPS-67	10.5	7.5	5.2	1.4	5.5	1000

PART NO	A	B	C	D	E	PACKAGE
RUPS-70	12.9	10.5	6.3	0.8	2.4	2000

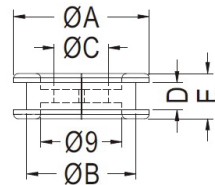
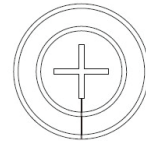
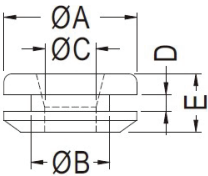
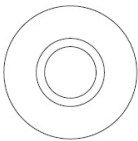

PART NO	A	B	C	D	E	PACKAGE
RUPS-68	16.0	9.5	6.2	2.0	7.0	1000

PART NO	A	B	C	D	E	PACKAGE
RUPS-71	15.0	12.1	6.0	3.0	5.0	1000

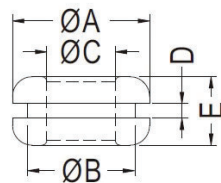
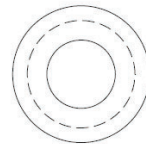
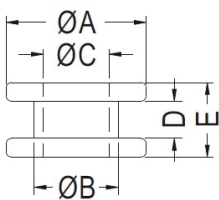
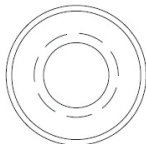

PART NO	A	B	C	D	E	PACKAGE
RUPS-69	7.5	4.5	3.5	2.0	4.0	1000

PART NO	A	B	C	D	E	PACKAGE
RUPS-72	12.0	9.0	6.0	1.5	7.0	1000
RUPS-73	14.0	11.0	6.1	1.5	7.0	1000

橡胶线环 GROMMET 橡胶圈 护线圈



- ◆ MATERIAL : RUBBER/SILICON BURBBER
- ◆ COLOR : BLACK
- ◆ UNIT: mm

用途：橡胶线环，用于机壳的电线出线口，保护电线不受机壳刮伤，装配容易。

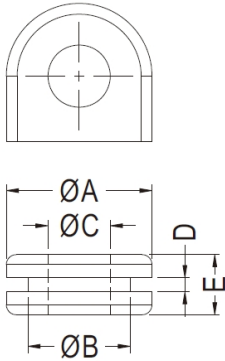

PART NO	A	B	C	D	E	PACKAGE
RUPS-74	14.5	10.2	6.2	1.4	6.0	1000

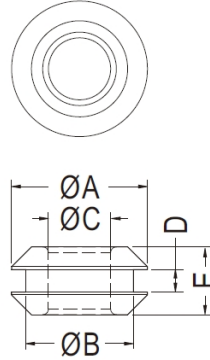

RUPS-79

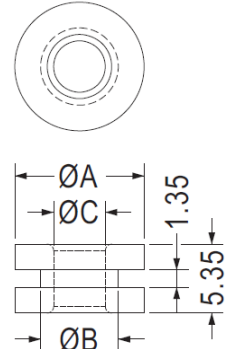

RUPS-78

PART NO	A	B	C	D	E	PACKAGE
RUPS-79	4.8	3.8	2.2	0.8	2.4	1000
RUPS-78	10.0	6.0	4.0	1.35	5.35	1000

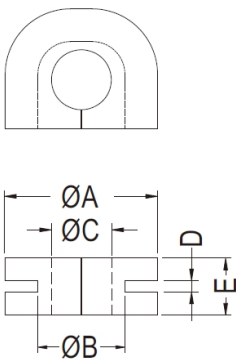

PART NO	A	B	C	D	E	PACKAGE
RUPS-75	14.0	8.0	5.5	1.0	5.2	1000

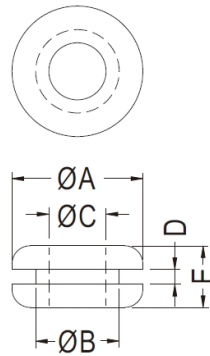

PART NO	A	B	C	D	E	PACKAGE
RUPS-81	15.9	11.1	7.9	1.6	7.1	1000

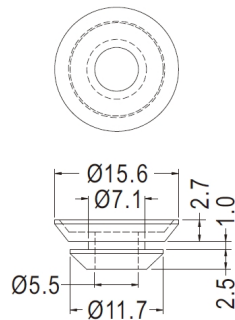

PART NO	PACKAGE
RUPS-44	1000

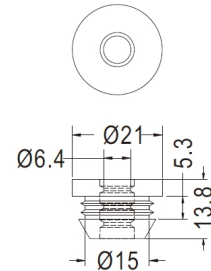

MOUNTING HOLE Ø15.0~Ø15.5

PART NO	PACKAGE
RUPS-45	1000

装配孔尺寸，仅供参考
Mounting holes are for reference only.

橡胶线环 GROMMET 橡胶圈 护线圈



- ◆ MATERIAL : RUBBER/SILICON BURBBER
- ◆ COLOR : BLACK
- ◆ UNIT: mm

用途：橡胶线环，用于机壳的电线出线口，保护电线不受机壳刮伤，装配容易。

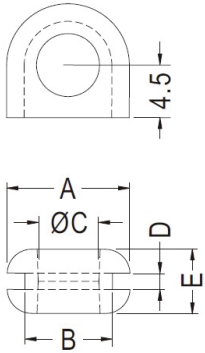

PART NO	A	B	C	D	E	PACKAGE
RUPS-67	10.5	7.5	5.2	1.4	5.5	1000

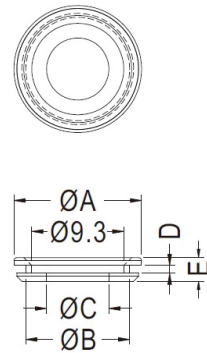

PART NO	A	B	C	D	E	PACKAGE
RUPS-70	12.9	10.5	6.3	0.8	2.4	2000

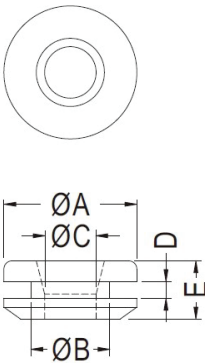

PART NO	A	B	C	D	E	PACKAGE
RUPS-68	16.0	9.5	6.2	2.0	7.0	1000

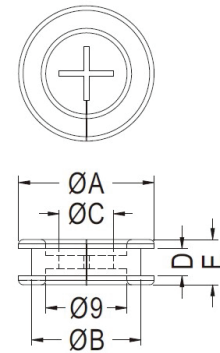

PART NO	A	B	C	D	E	PACKAGE
RUPS-71	15.0	12.1	6.0	3.0	5.0	1000

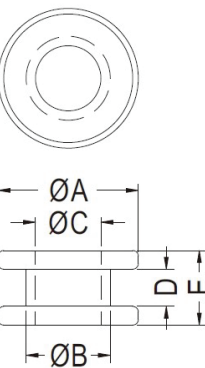

PART NO	A	B	C	D	E	PACKAGE
RUPS-69	7.5	4.5	3.5	2.0	4.0	1000

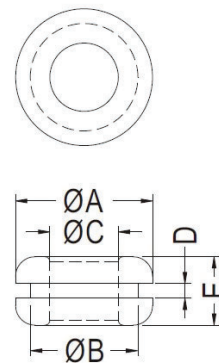

PART NO	A	B	C	D	E	PACKAGE
RUPS-72	12.0	9.0	6.0	1.5	7.0	1000
RUPS-73	14.0	11.0	6.1	1.5	7.0	1000

硅胶线环 SILICON GROMMET 橡胶圈 护线圈

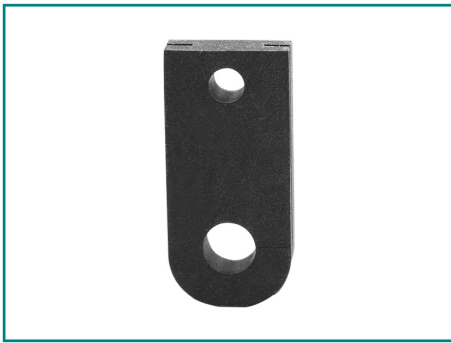

- ◆ MATERIAL : SILICON BURBBER
- ◆ COLOR : BLACK
- ◆ UNIT: mm

用途：硅胶线环，用于机壳的电线出线口，保护电线不受机壳刮伤，装配容易。

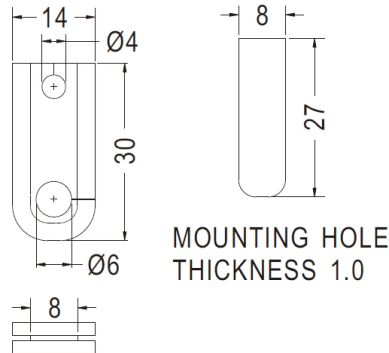

PART NO	PACKAGE
RUPS-76	1000

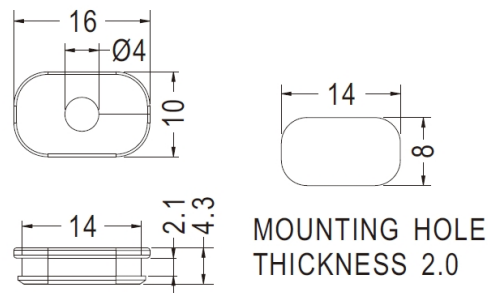
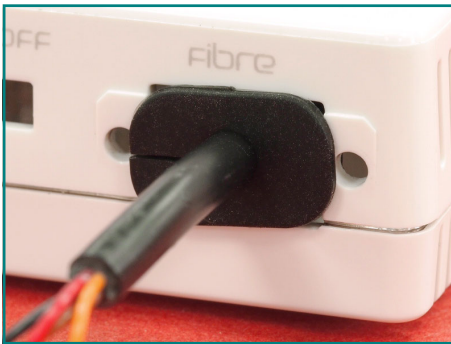

PART NO	PACKAGE
RUPS-77	1000



- ◆ MATERIAL : SILICON BURBBER(UL)
- ◆ FLAME : 94V -0
- ◆ COLOR : BLACK
- ◆ UNIT: mm

用途：导电护线环，用于机壳的电线出线口，保护电线不受机壳刮伤，装配容易。

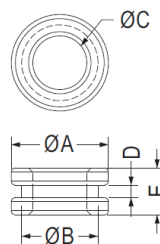

PART NO	A	B	C	D	E	PACKAGE
STGM-1	8.15	6.0	4.0	0.8	3.8	2000
STGM-2	7.0	5.5	3.9	0.9	3.4	2000

硅胶护线环 GROMMET 橡胶圈 护线圈

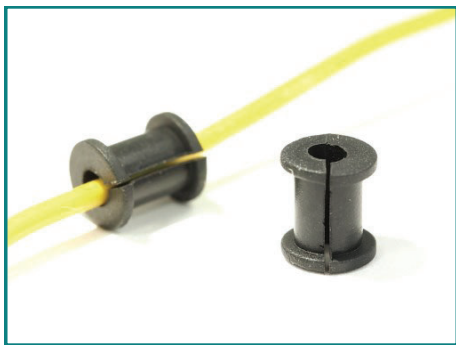

- ◆ MATERIAL : SILICON BURBBER(UL)
- ◆ FLAME : 94V -0
- ◆ COLOR : BLACK
- ◆ UNIT: mm

用途：硅胶护线环，用于机壳的电线出线口，保护电线不受机壳刮伤，装配容易。

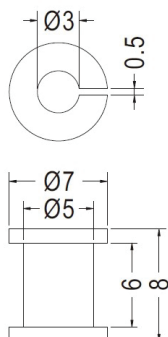

PART NO	PACKAGE
SG-1	1000



- ◆ MATERIAL : SILICON BURBBER
- ◆ COLOR : BLACK
- ◆ UNIT: mm

用途：硅胶护线环，用于机壳的电线出线口，保护电线不受机壳刮伤，装配容易。

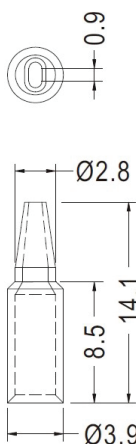

PART NO	PACKAGE
SG-2	1000

天线护线环 GROMMET 橡胶圈 护线圈

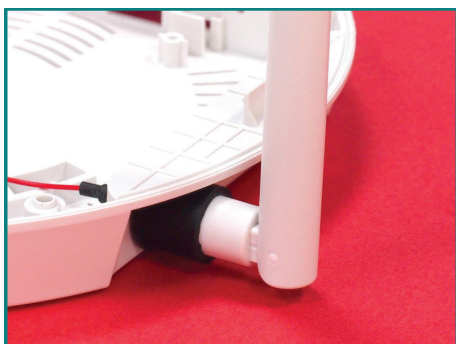

- ◆ MATERIAL : SILICON BURBBER
- ◆ COLOR : BLACK / WHITE
- ◆ UNIT: mm

用途：天线护线环，用于天线之绝缘与保护。

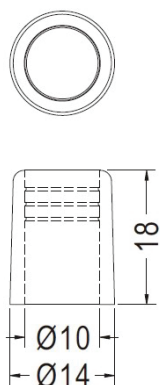

PART NO	PACKAGE
RUPS-57	500

方型护线环 SQUARE SNAP BUSHING 橡胶圈 护线圈



- ◆ MATERIAL : NYLON 66 (UL)
- ◆ FLAME CLASS : 94V-0/94V-2
- ◆ COLOR : BLACK/NATURAL
- ◆ UNIT: mm

用途：方型护线环，用于铁板间电线出入刮伤之保护，不易脱落，使用方便，不占空间之优点。

装配孔尺寸，仅供参考
Mounting holes are for reference only.

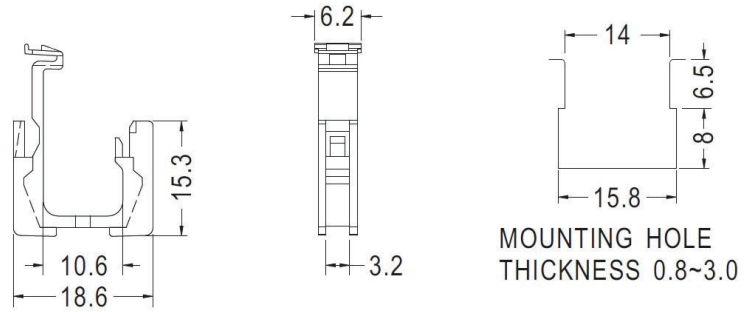

PART NO	PACKAGE
LSW-1	1000

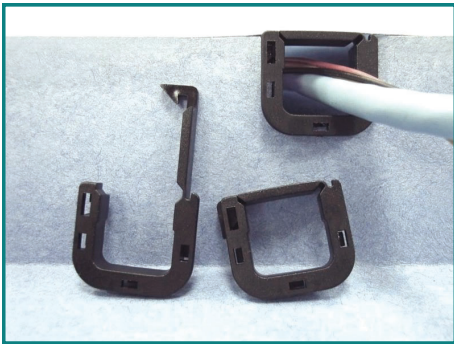

装配孔尺寸，仅供参考
Mounting holes are for reference only.

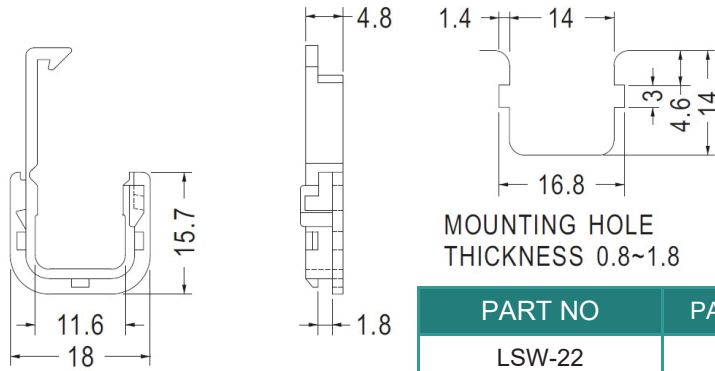

PART NO	PACKAGE
LSW-22	1000



装配孔尺寸，仅供参考
Mounting holes are for reference only.

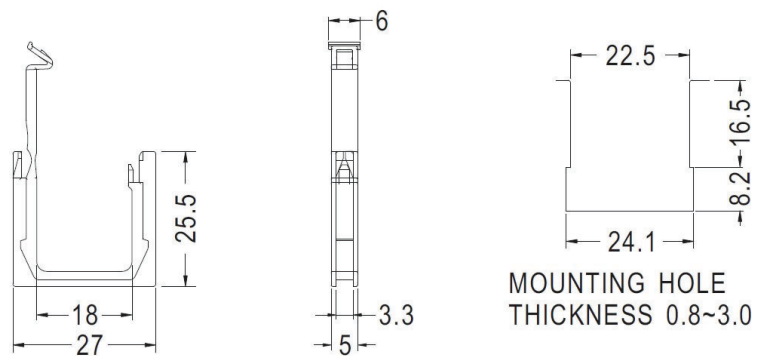

PART NO	PACKAGE
LSW-33	1000

方型护线环 SQUARE SNAP BUSHING 橡胶圈 护线圈



装配孔尺寸，仅供参考
Mounting holes are for reference only.

- ◆ MATERIAL : NYLON 66 (UL)
- ◆ FLAME CLASS : 94V-0/94V-2
- ◆ COLOR : BLACK/NATURAL
- ◆ UNIT: mm

用途：方型护线环，用于铁板间电线出入刮伤之保护，不易脱落，使用方便，不占空间之优点。

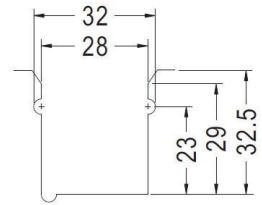
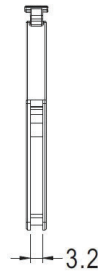
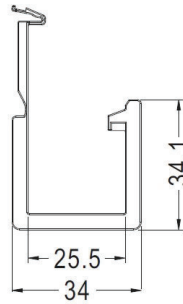

MOUNTING HOLE THICKNESS 3.0

PART NO	PACKAGE
LSW-40	1000



装配孔尺寸，仅供参考
Mounting holes are for reference only.

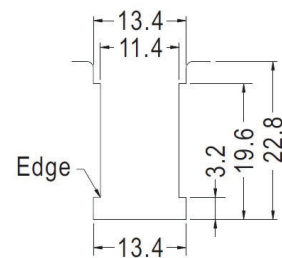
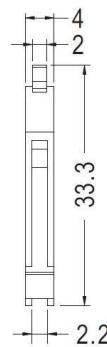
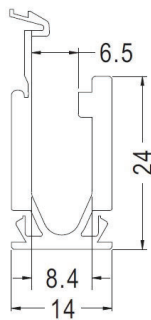

MOUNTING HOLE THICKNESS 2.0

PART NO	PACKAGE
LSW-41	500

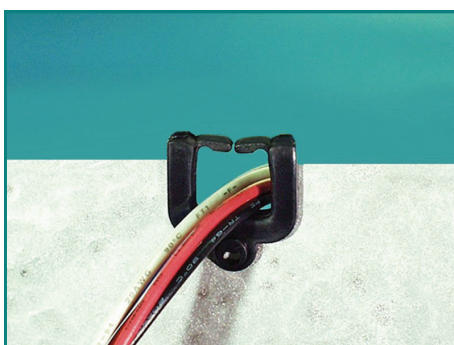

装配孔尺寸，仅供参考
Mounting holes are for reference only.

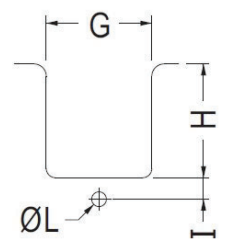
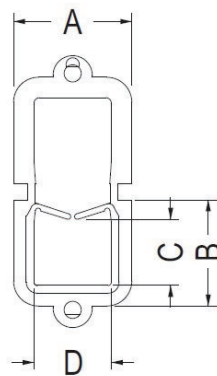

MOUNTING HOLE THICKNESS 0.8~2.0

PART NO	A	B	C	D	G	H	I	L	PACKAGE
LSW-2	18.4	14.5	8.9	11.0	14.0	12.3	2.7	2.7	500
LSW-3	21.5	18.8	11.9	13.9	17.2	18.5	3.5	3.0	500

方型护线环 SQUARE SNAP BUSHING 橡胶圈 护线圈

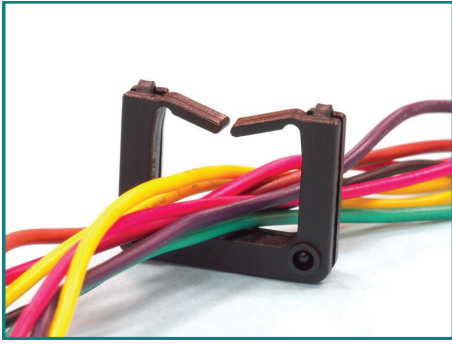

装配孔尺寸，仅供参考
Mounting holes are for reference only.

- ◆ MATERIAL : NYLON 66 (UL)
- ◆ FLAME CLASS : 94V-0/94V-2
- ◆ COLOR : BLACK/NATURAL
- ◆ UNIT: mm

用途：方型护线环，用于铁板间电线出入刮伤之保护，不易脱落，使用方便，不占空间之优点。

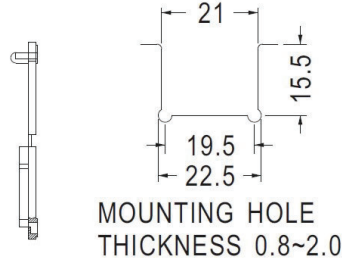
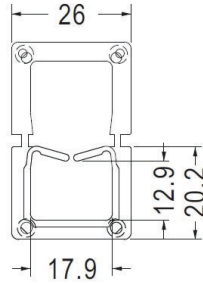

PART NO	PACKAGE
LSW-4	500

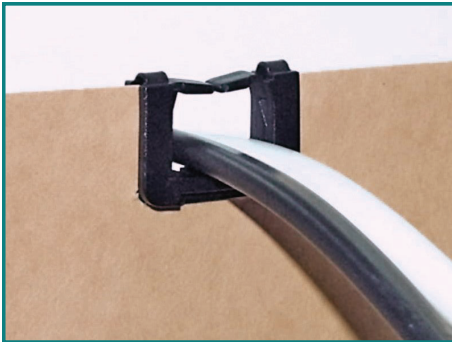

装配孔尺寸，仅供参考
Mounting holes are for reference only.

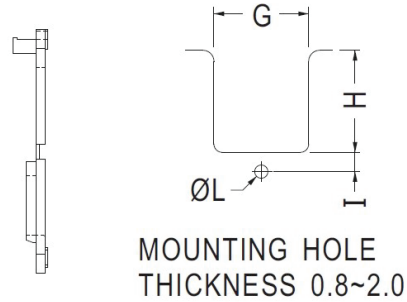
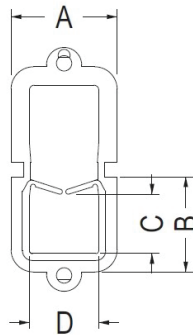

PART NO	A	B	C	D	G	H	J	PACKAGE
LSW-5	22.0	14.2	9.0	14.0	17.0	13.5	19.0	500
LSW-6	17.9	11.8	6.8	10.9	14.0	10.5	16.0	100



装配孔尺寸，仅供参考
Mounting holes are for reference only.

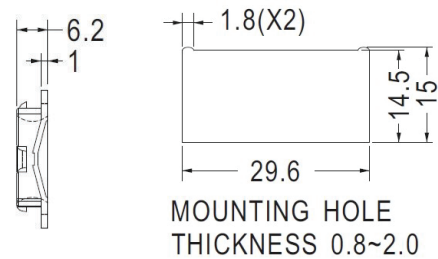
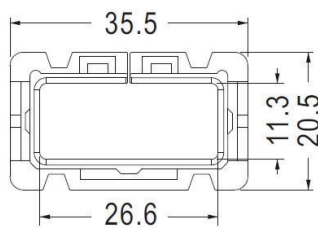

PART NO	PACKAGE
LSW-32	500

方型护线环 SQUARE SNAP BUSHING 橡胶圈 护线圈



装配孔尺寸，仅供参考
Mounting holes are for reference only.

- ◆ MATERIAL : NYLON 66 (UL)
- ◆ FLAME CLASS : 94V-0/94V-2
- ◆ COLOR : BLACK/NATURAL
- ◆ UNIT: mm

用途：方型护线环，用于铁板间电线出入刮伤之保护，不易脱落，使用方便，不占空间之优点。

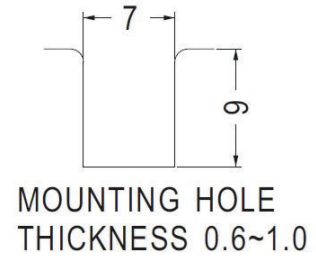
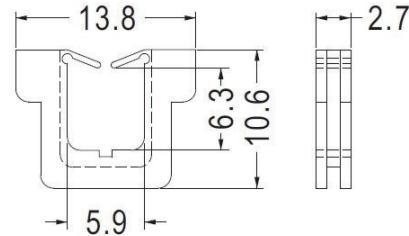

PART NO	PACKAGE
LSW-7	1000

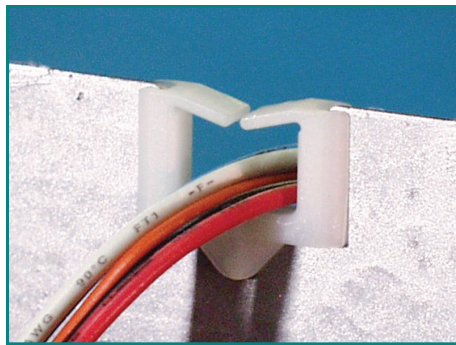

装配孔尺寸，仅供参考
Mounting holes are for reference only.

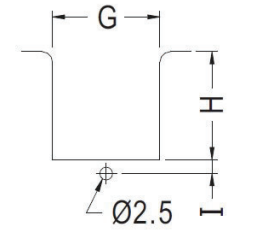
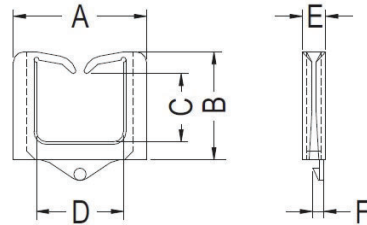

PART NO	A	B	C	D	E	F	G	H	I	PACKAGE
LSW-8	19.8	12.1	7.3	11.5	4.5	2.3	14.0	12.3	2.8	1000
LSW-9	26.0	21.0	14.0	17.0	4.6	2.3	21.0	21.0	2.7	500
LSW-10	33.2	28.8	22.4	22.7	4.5	2.3	27.0	29.0	2.8	500
LSW-27	26.0	21.0	14.0	17.0	4.6	1.87	21.0	21.0	2.7	500

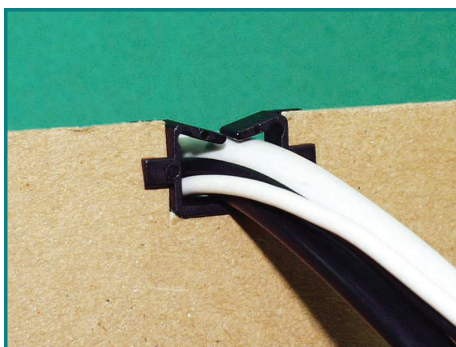

装配孔尺寸，仅供参考
Mounting holes are for reference only.

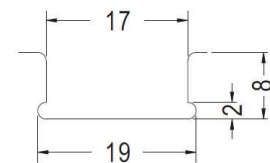
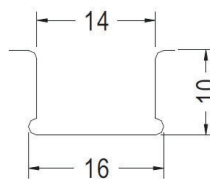
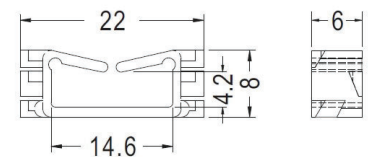
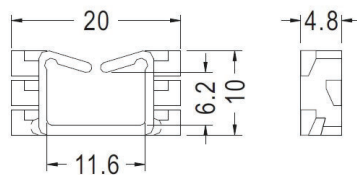

PART NO	T	PACKAGE
LSW-11	0.8~1.2	500
LSW-28	1.9~2.0	500

PART NO	PACKAGE
LSW-12	500

方型护线环 SQUARE SNAP BUSHING 橡胶圈 护线圈

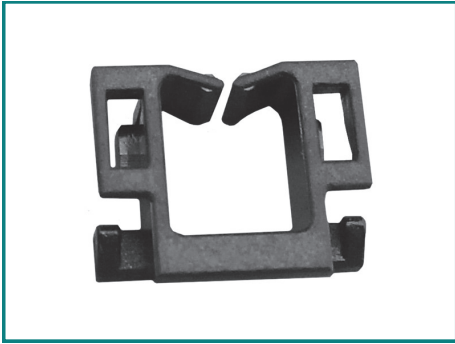

装配孔尺寸，仅供参考
Mounting holes are for reference only.

- ◆ MATERIAL : NYLON 66 (UL)
- ◆ FLAME CLASS : 94V-0/94V-2
- ◆ COLOR : BLACK/NATURAL
- ◆ UNIT: mm

用途：方型护线环，用于铁板间电线出入刮伤之保护，不易脱落，使用方便，不占空间之优点。

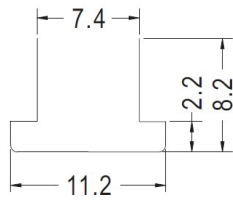
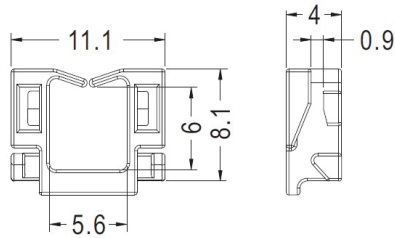

MOUNTING HOLE THICKNESS 1.2

PART NO	PACKAGE
LSW-13	500

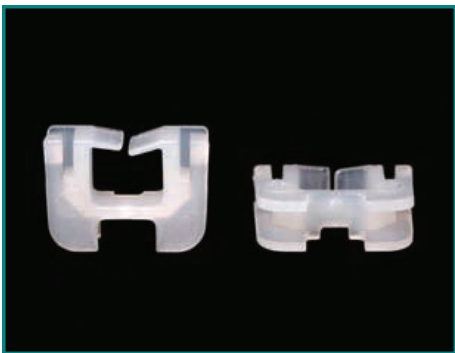

装配孔尺寸，仅供参考
Mounting holes are for reference only.

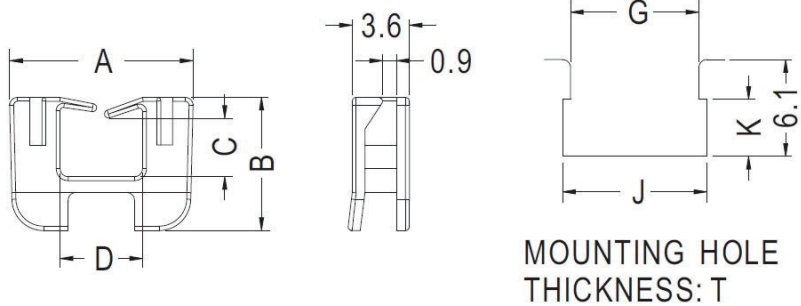

MOUNTING HOLE THICKNESS: T

PART NO	A	B	C	D	G	J	K	T	PACKAGE
LSW-14	11.6	8.4	3.7	5.2	8.1	9.1	3.6	0.8~1.8	500
LSW-29	16.9	9.1	3.4	10.2	12.8	13.8	3.4	0.9~2.0	500
LSW-51	16.9	9.0	3.2	10.2	13.0	14.0	3.4	0.9~2.0	500

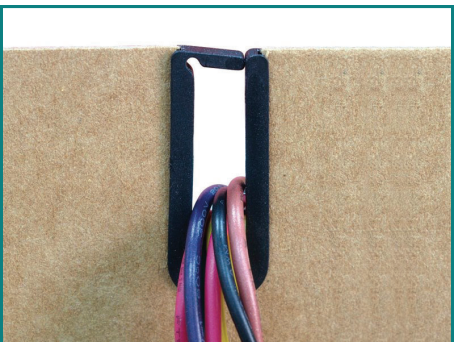

装配孔尺寸，仅供参考
Mounting holes are for reference only.

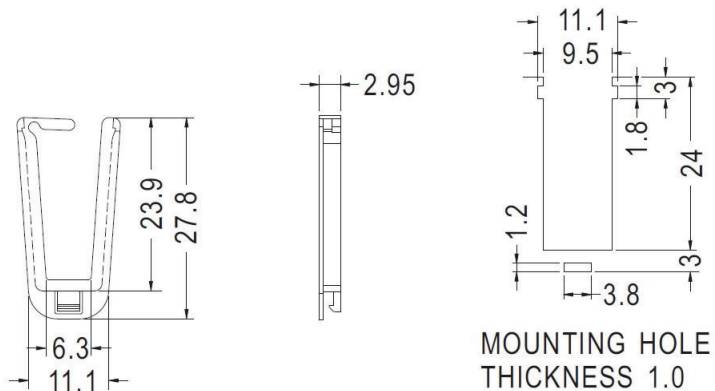

MOUNTING HOLE THICKNESS 1.0

PART NO	PACKAGE
LSW-46	500

方型护线环 SQUARE SNAP BUSHING 橡胶圈 护线圈



装配孔尺寸，仅供参考
Mounting holes are for reference only.

- ◆ MATERIAL : NYLON 66 (UL)
- ◆ FLAME CLASS : 94V-0/94V-2
- ◆ COLOR : BLACK/NATURAL
- ◆ UNIT: mm

用途：方型护线环，用于铁板间电线出入刮伤之保护，不易脱落，使用方便，不占空间之优点。

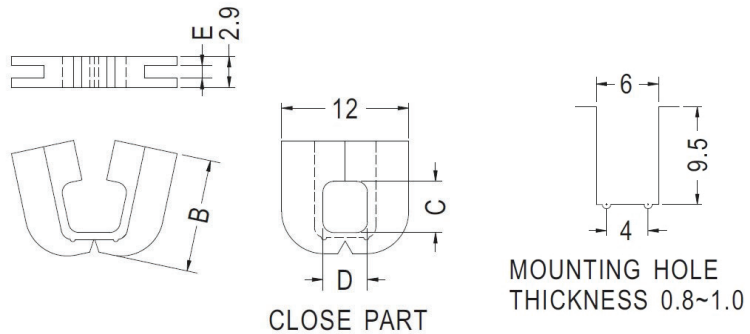

PART NO	B	C	D	E	PACKAGE
LSW-15	10.6	4.8	4.2	1.2	1000
LSW-16	10.9	4.5	2.3	1.1	1000
LSW-17	10.7	4.6	4.6	1.1	1000
LSW-19	10.9	6.8	2.3	1.2	1000



装配孔尺寸，仅供参考
Mounting holes are for reference only.

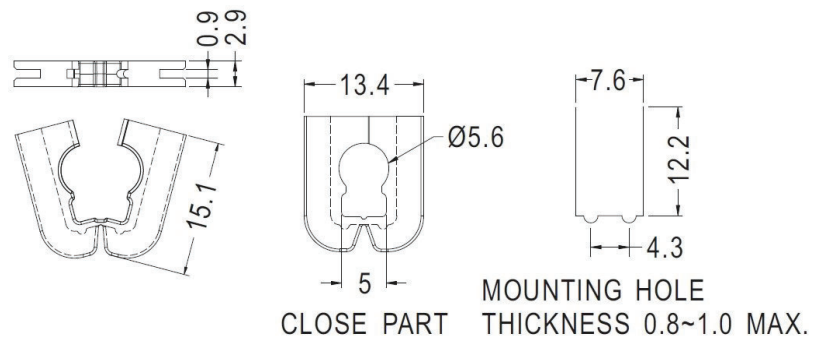

PART NO	PACKAGE
LSW-18	1000

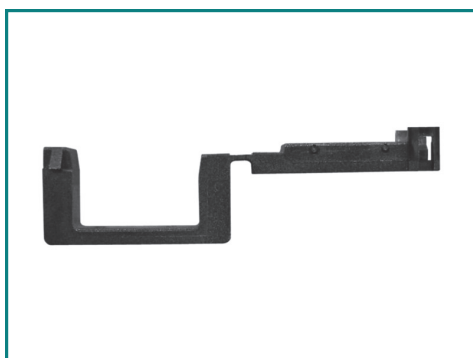

装配孔尺寸，仅供参考
Mounting holes are for reference only.

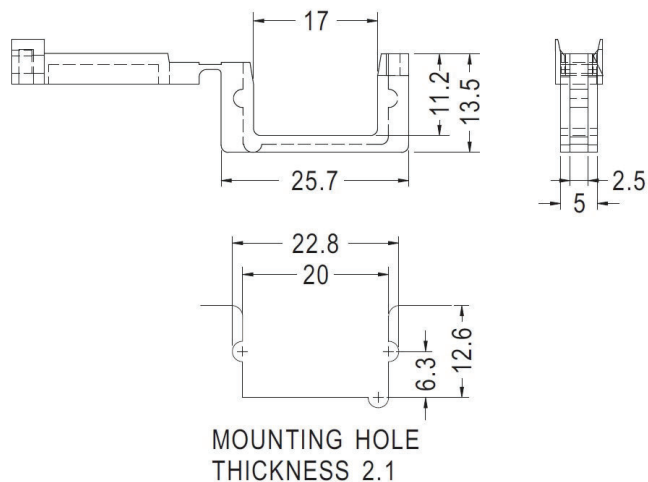

PART NO	PACKAGE
LSW-23	1000

方型护线环 SQUARE SNAP BUSHING 橡胶圈 护线圈



- ◆ MATERIAL : NYLON 66 (UL)
- ◆ FLAME CLASS : 94V-0/94V-2
- ◆ COLOR : BLACK/NATURAL
- ◆ UNIT: mm

用途：方型护线环，用于铁板间电线出入刮伤之保护，不易脱落，使用方便，不占空间之优点。

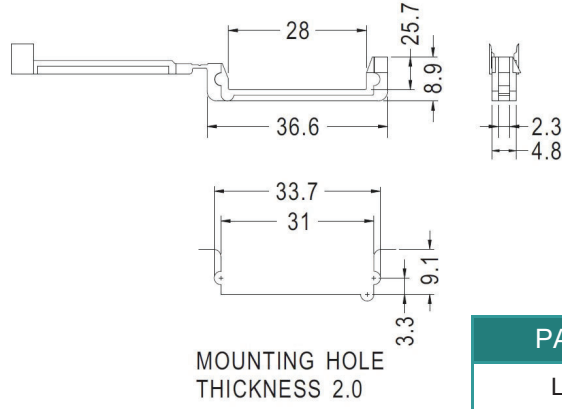

PART NO	PACKAGE
LSW-24	1000

装配孔尺寸，仅供参考
Mounting holes are for reference only.

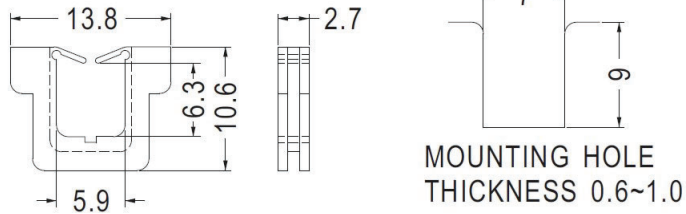

PART NO	PACKAGE
LSW-25	1000

装配孔尺寸，仅供参考
Mounting holes are for reference only.



PANEL MOUNTING DETAILS

THROUGH HOLE INSTALLATION EDGE INSTALLATION

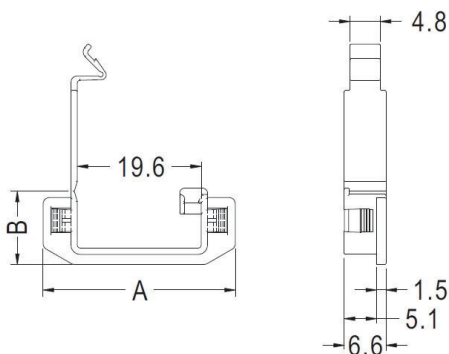
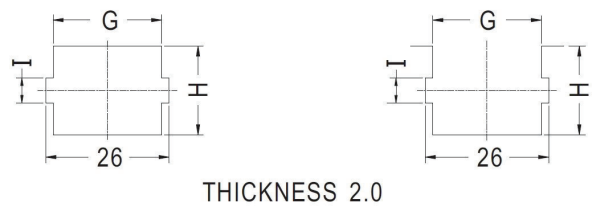
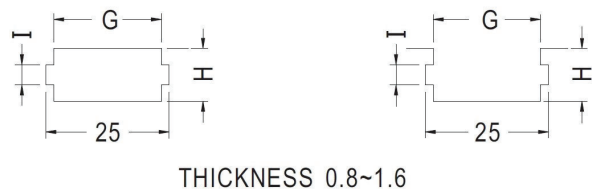

装配孔尺寸，仅供参考
Mounting holes are for reference only.

PART NO	A	B	G	H	I	PACKAGE
LSW-30	30.4	11.6	21.8	10.7	4.1	500
LSW-31	31.0	18.6	22.0	18.0	5.0	500

方型护线环 SQUARE SNAP BUSHING 橡胶圈 护线圈

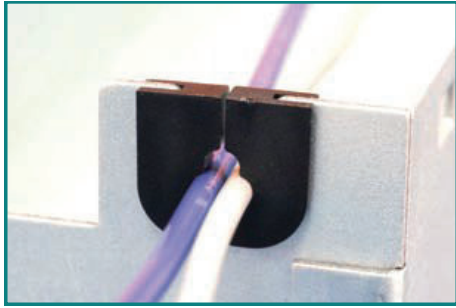

- ◆ MATERIAL : NYLON 66 (UL)
- ◆ FLAME CLASS : 94V-0/94V-2
- ◆ COLOR : BLACK/NATURAL
- ◆ UNIT: mm

用途：方型护线环，用于铁板间电线出入刮伤之保护，不易脱落，使用方便，不占空间之优点。

装配孔尺寸，仅供参考
Mounting holes are for reference only.

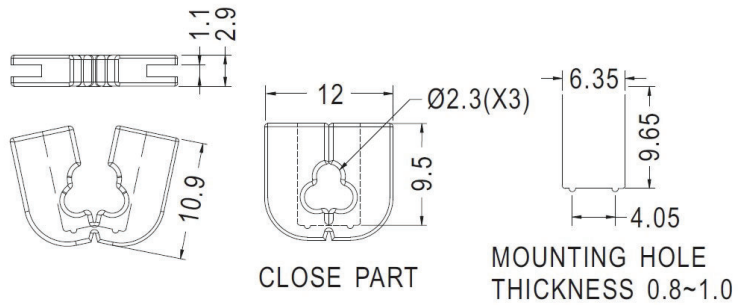

PART NO	PACKAGE
LSW-34	1000

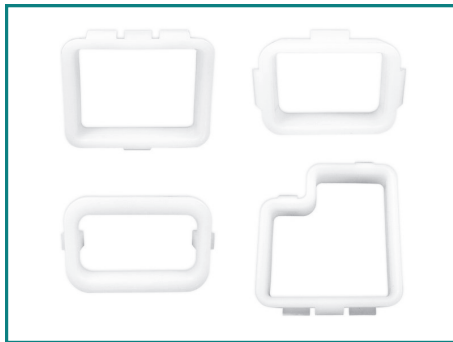

装配孔尺寸，仅供参考
Mounting holes are for reference only.

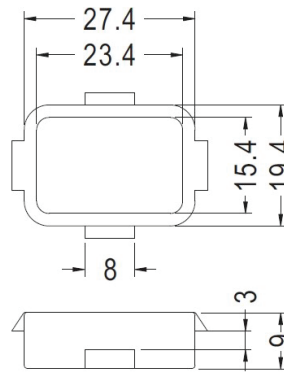

PART NO	PACKAGE
LSW-35	1000

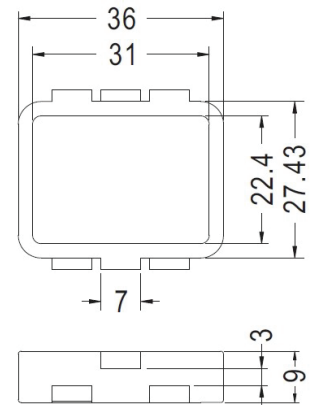

PART NO	PACKAGE
LSW-36	500

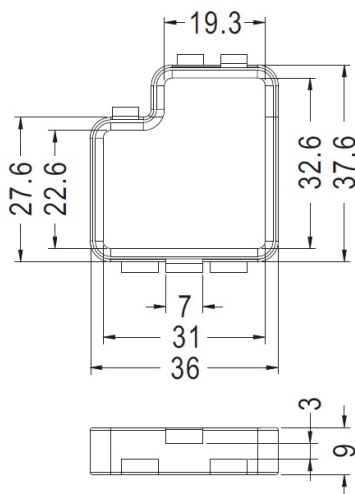

PART NO	PACKAGE
LSW-37	1000

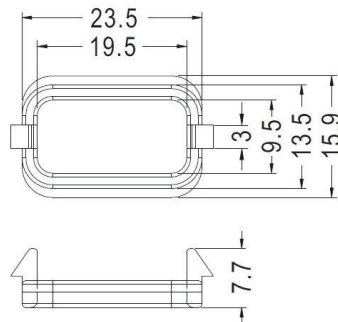

PART NO	PACKAGE
LSW-38	1000

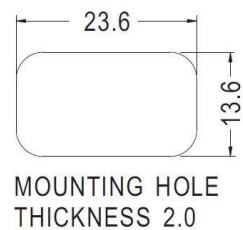

方型护线环 SQUARE SNAP BUSHING 橡胶圈 护线圈



- ◆ MATERIAL : NYLON 66 (UL)
- ◆ FLAME CLASS : 94V-0/94V-2
- ◆ COLOR : BLACK/NATURAL
- ◆ UNIT: mm

用途：方型护线环，用于铁板间电线出入刮伤之保护，不易脱落，使用方便，不占空间之优点。

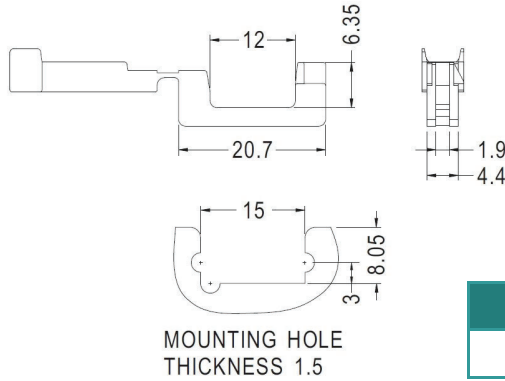

PART NO	PACKAGE
LSW-39	1000

装配孔尺寸，仅供参考
Mounting holes are for reference only.

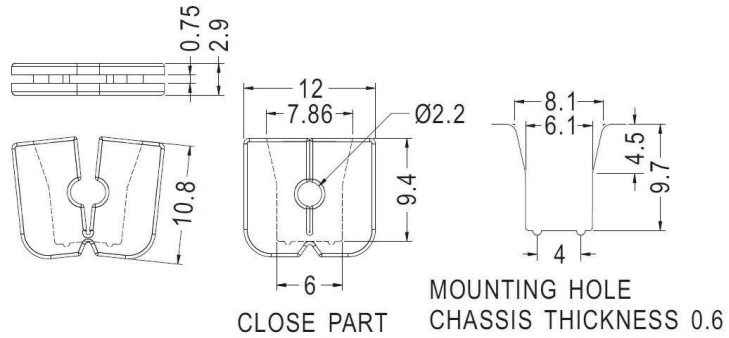

PART NO	PACKAGE
LSW-42	1000

装配孔尺寸，仅供参考
Mounting holes are for reference only.

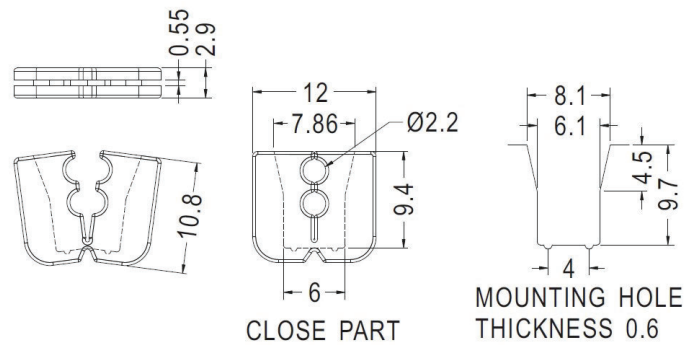

PART NO	PACKAGE
LSW-43	1000

装配孔尺寸，仅供参考
Mounting holes are for reference only.

方型护线环 SQUARE SNAP BUSHING 橡胶圈 护线圈

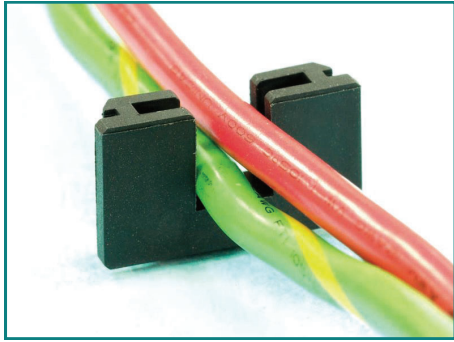

装配孔尺寸，仅供参考
Mounting holes are for reference only.

- ◆ MATERIAL : NYLON 66 (UL)
- ◆ FLAME CLASS : 94V-0/94V-2
- ◆ COLOR : BLACK/NATURAL
- ◆ UNIT: mm

用途：方型护线环，用于铁板间电线
出入刮伤之保护，不易脱落，
使用方便，不占空间之优点。

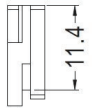
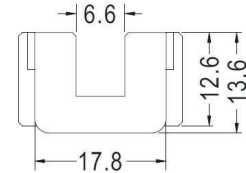
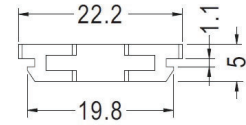
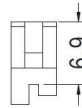
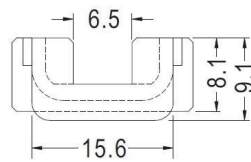
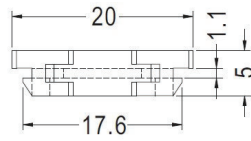

PART NO	PACKAGE
LSW-44	1000

PART NO	PACKAGE
LSW-50	1000

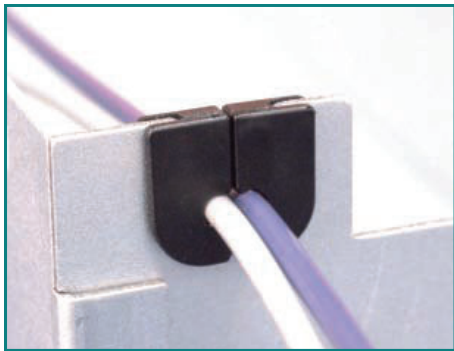

装配孔尺寸，仅供参考
Mounting holes are for reference only.

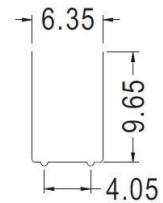
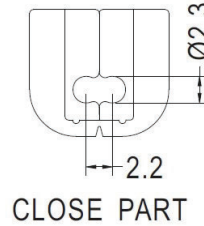
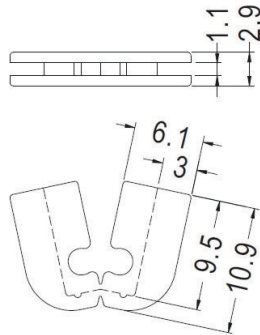

MOUNTING HOLE
THICKNESS 0.8~1.0

CLOSE PART

PART NO	PACKAGE
LSW-45	1000

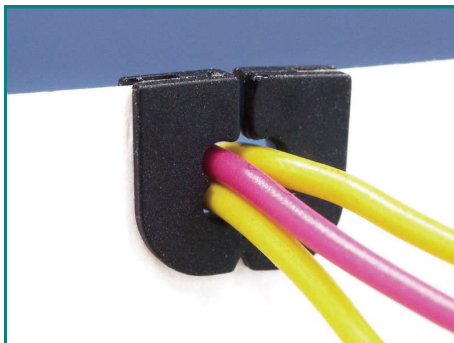

装配孔尺寸，仅供参考
Mounting holes are for reference only.

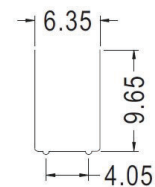
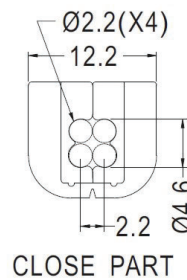
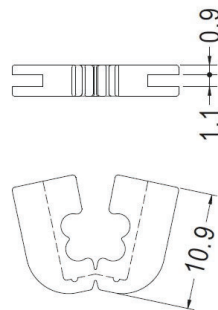

MOUNTING HOLE
THICKNESS 0.8~1.0

CLOSE PART

PART NO	PACKAGE
LSW-47	1000

方型护线环 SQUARE SNAP BUSHING 橡胶圈 护线圈

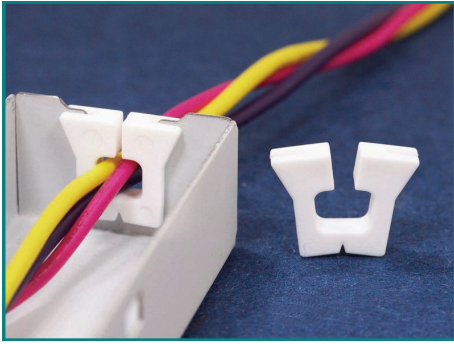

装配孔尺寸，仅供参考
Mounting holes are for reference only.

- ◆ MATERIAL : NYLON 66 (UL)
- ◆ FLAME CLASS : 94V-0/94V-2
- ◆ COLOR : BLACK/NATURAL
- ◆ UNIT: mm

用途：方型护线环，用于铁板间电线
出入刮伤之保护，不易脱落，
使用方便，不占空间之优点。

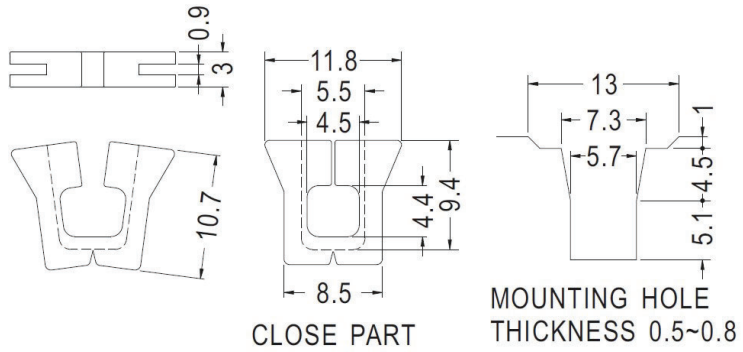

PART NO	PACKAGE
LSW-48	1000

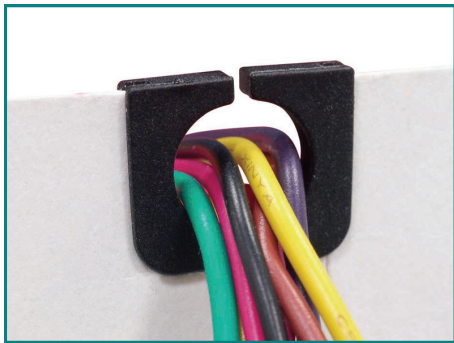

装配孔尺寸，仅供参考
Mounting holes are for reference only.

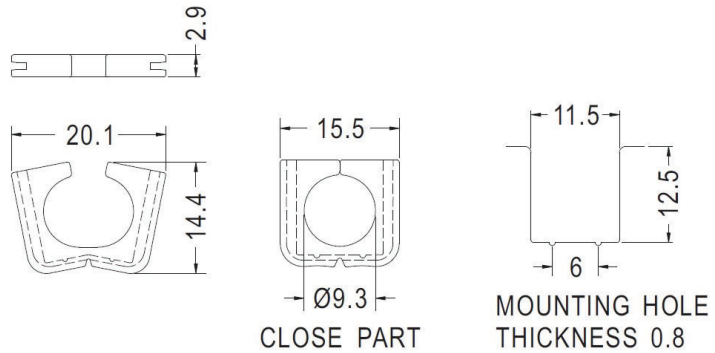

PART NO	PACKAGE
LSW-49	1000

U型护线环 U TYPE SNAP BUSHING 橡胶圈 护线圈

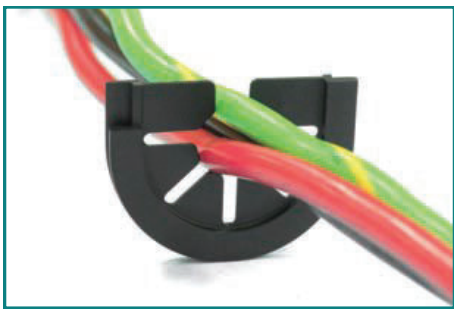

装配孔尺寸，仅供参考
Mounting holes are for reference only.

- ◆ MATERIAL : NYLON 66 (UL)
- ◆ FLAME CLASS : 94V-0/94V-2
- ◆ COLOR : BLACK/NATURAL
- ◆ UNIT: mm

用途： U型护线环，用于铁板间电线
出入刮伤之保护，不易脱落，
使用方便，不占空间之优点。

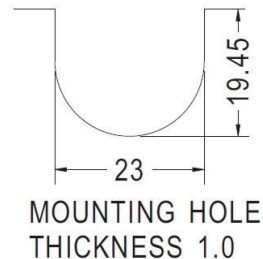
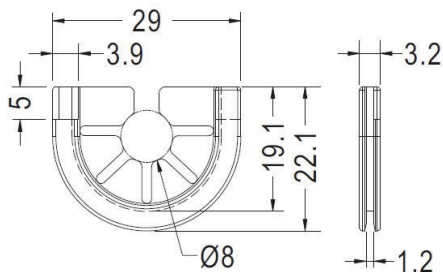

PART NO	PACKAGE
SQ-1	1000

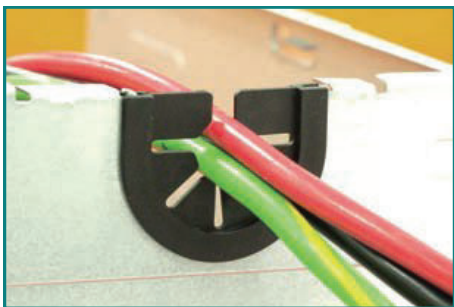

装配孔尺寸，仅供参考
Mounting holes are for reference only.

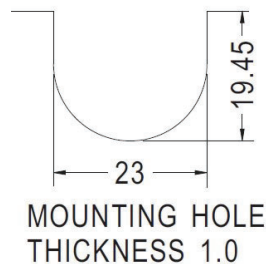
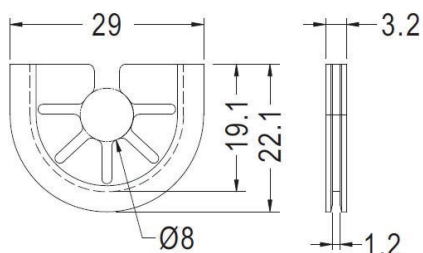

PART NO	PACKAGE
SQ-2	1000



装配孔尺寸，仅供参考
Mounting holes are for reference only.

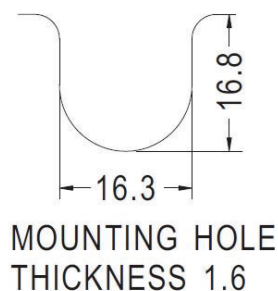
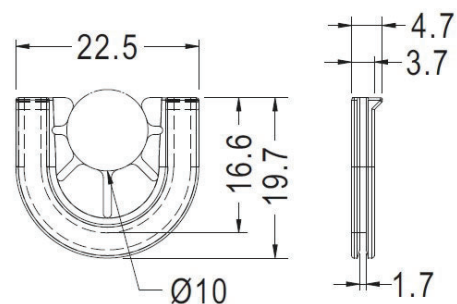

PART NO	PACKAGE
SQ-3	1000

U型护线环 U TYPE SNAP BUSHING 橡胶圈 护线圈



- ◆ MATERIAL : NYLON 66 (UL)
- ◆ FLAME CLASS : 94V-0/94V-2
- ◆ COLOR : BLACK/NATURAL
- ◆ UNIT: mm

用途: U型护线环, 用于铁板间电线出入刮伤之保护, 不易脱落, 使用方便, 不占空间之优点。

装配孔尺寸, 仅供参考
Mounting holes are for reference only.

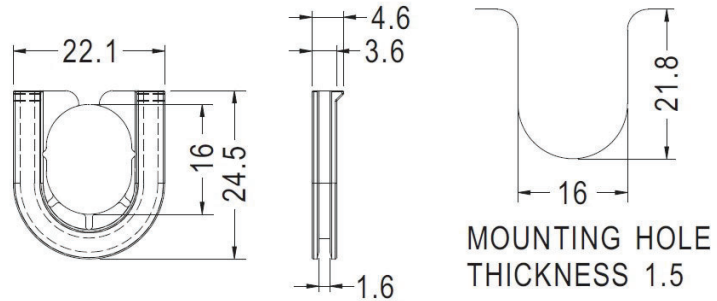

PART NO	PACKAGE
SQ-4	1000

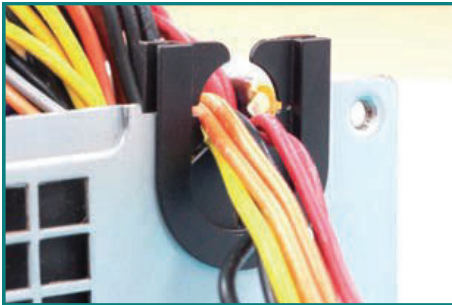

装配孔尺寸, 仅供参考
Mounting holes are for reference only.

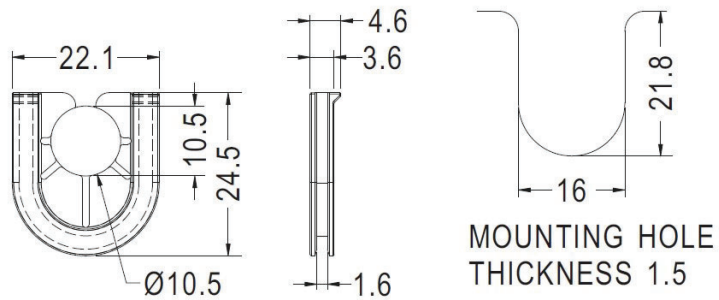

PART NO	PACKAGE
SQ-5	1000



装配孔尺寸, 仅供参考
Mounting holes are for reference only.

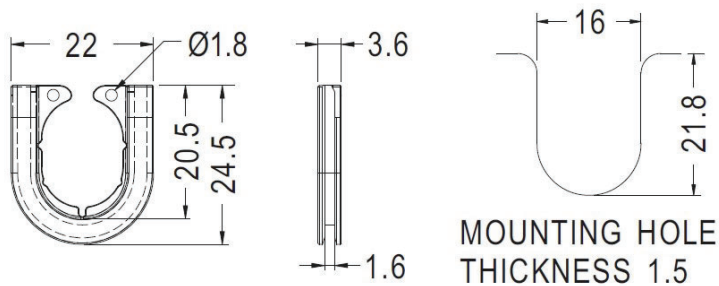

PART NO	PACKAGE
SQ-6	1000

U型护线环 U TYPE SNAP BUSHING 橡胶圈 护线圈



装配孔尺寸，仅供参考
Mounting holes are for reference only.

- ◆ MATERIAL : NYLON 66 (UL)
- ◆ FLAME CLASS : 94V-0/94V-2
- ◆ COLOR : BLACK/NATURAL
- ◆ UNIT: mm

用途： U型护线环，用于铁板间电线出入刮伤之保护，不易脱落，使用方便，不占空间之优点。

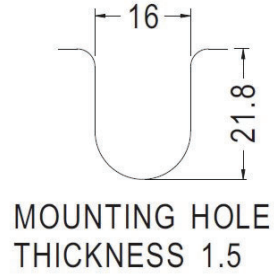
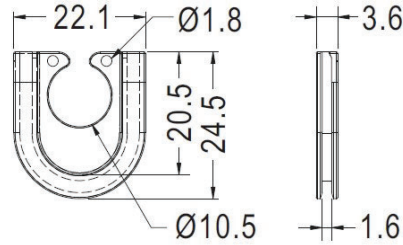

PART NO	PACKAGE
SQ-7	1000

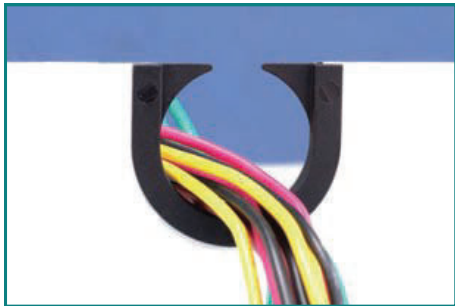

装配孔尺寸，仅供参考
Mounting holes are for reference only.

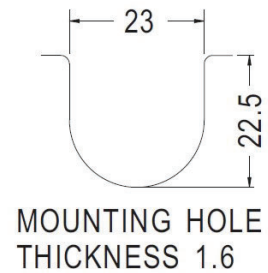
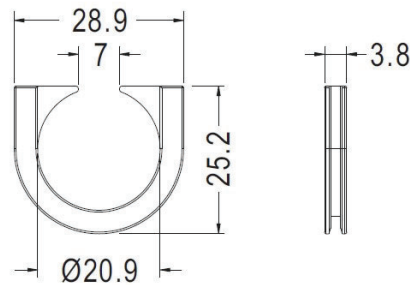

PART NO	PACKAGE
SQ-9	1000

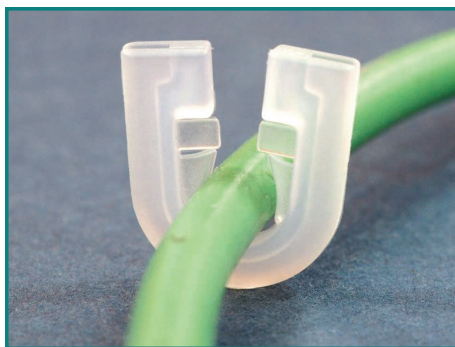

装配孔尺寸，仅供参考
Mounting holes are for reference only.

- ◆ MATERIAL : PE
- ◆ COLOR : NATURAL
- ◆ UNIT: mm

用途： U型护线环，用于铁板间电线出入刮伤之保护，不易脱落，使用方便，不占空间之优点。

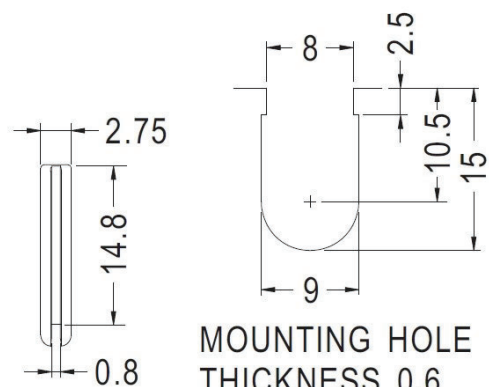
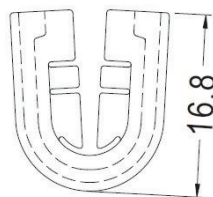

PART NO	PACKAGE
SQ-8	1000

U型护线环 U TYPE SNAP BUSHING 橡胶圈 护线圈



装配孔尺寸，仅供参考
Mounting holes are for reference only.

- ◆ MATERIAL : NYLON 66 (UL)
- ◆ FLAME CLASS : 94V-0/94V-2
- ◆ COLOR : BLACK/NATURAL
- ◆ UNIT: mm

用途： U型护线环，用于铁板间电线
出入刮伤之保护，不易脱落，
使用方便，不占空间之优点。

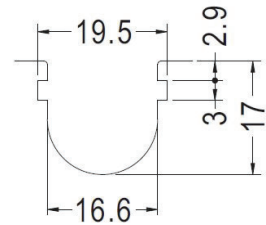
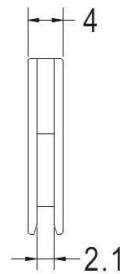
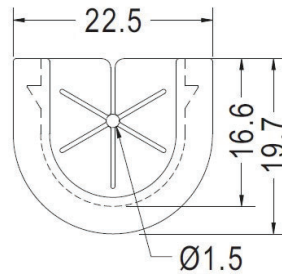

MOUNTING HOLE THICKNESS 2.0

PART NO	PACKAGE
SQ-10	1000

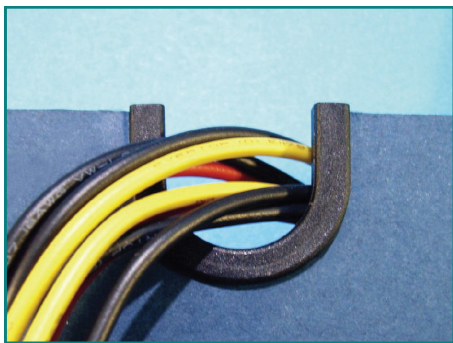

装配孔尺寸，仅供参考
Mounting holes are for reference only.

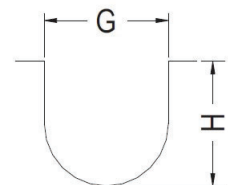
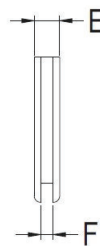
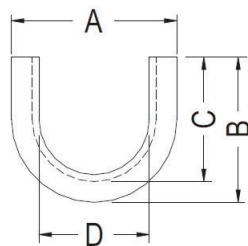

MOUNTING HOLE THICKNESS: T

PART NO	A	B	C	D	E	F	G	H	T	PACKAGE
SQ-11	24.0	21.0	18.0	16.0	3.7	1.8	18.0	18.0	1.7~1.8	1000
SQ-12	24.3	27.0	24.5	17.5	3.9	1.9	19.3	24.5	1.7~1.8	1000
SQ-14	24.3	27.1	24.5	17.5	4.1	2.1	19.3	24.5	2.0	1000



装配孔尺寸，仅供参考
Mounting holes are for reference only.

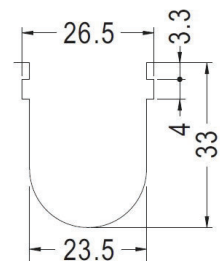
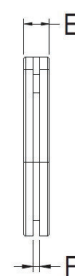
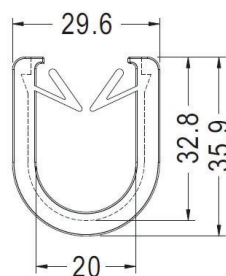

MOUNTING HOLE THICKNESS: T

PART NO	E	F	T	PACKAGE
SQ-13	5.0	1.3	0.8~1.2	1000
SQ-15	5.8	2.1	2.0	1000

抗震线环 ANTI-VIBRATION GROMMET 防震线环

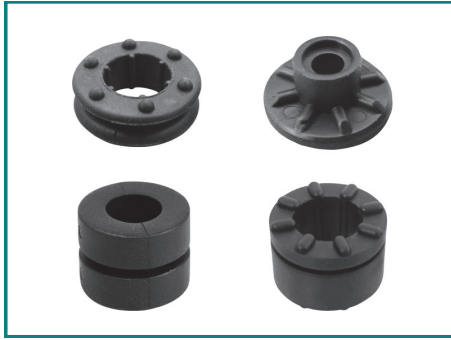

用途： 抗震线环，也称防震线环，用于硬盘及精密零件之防震。

G: 为45度硬度, H: 为55度硬度

- ◆ MATERIAL : TPE (UL 94V-0 is optional)
G: Hardness is Shore A45 H: Hardness is Shore A55
- ◆ COLOR : BLACK/BLUE
- ◆ UNIT: mm

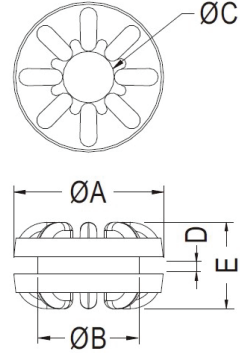
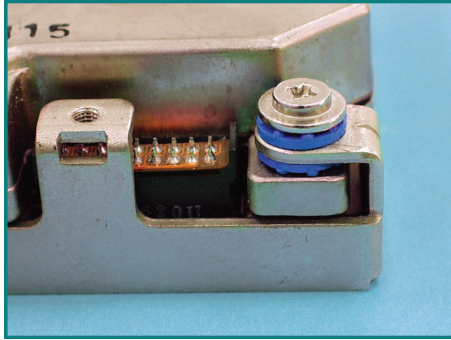

PART NO	A	B	C	D	E	PACKAGE
LTGM01	14.0	9.5	4.85	1.6	8.1	1000
LTGM02	14.0	11.0	4.85	1.6	8.1	1000
LTGM03	14.0	9.5	4.85	1.0	7.5	1000
LTGM04	14.0	9.5	4.85	1.0	8.1	1000
LTGM05	14.0	9.5	4.85	1.2	7.4	1000
LTGM82	14.3	9.52	4.78	1.65	8.2	1000

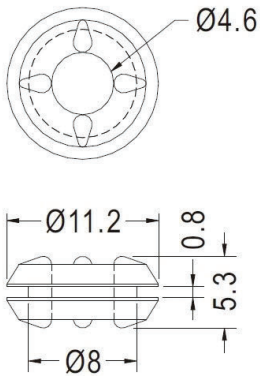

LTGM06可配合GPEK-08和GPEK-09螺絲用

PART NO	PACKAGE
LTGM06	1000

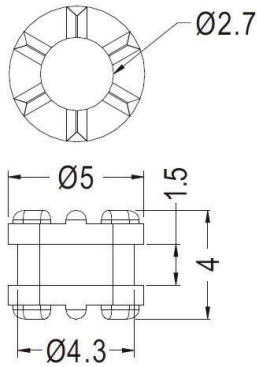

LTGM13可配合GPEK-05螺絲用

PART NO	PACKAGE
LTGM13	1000

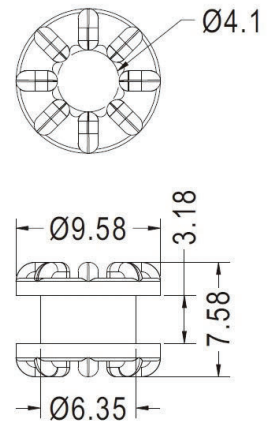

PART NO	PACKAGE
LTGM07	1000

抗震线环 ANTI-VIBRATION GROMMET 防震线环

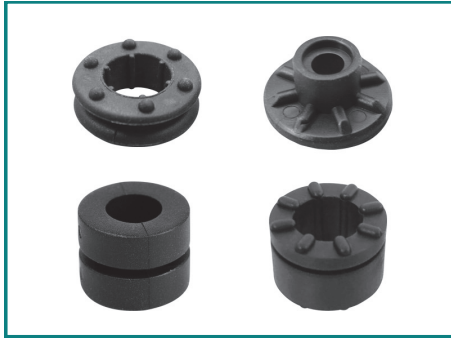

用途： 抗震线环，也称防震线环，用于硬盘及精密零件之防震。
G: 为45度硬度，H: 为55度硬度

- ◆ MATERIAL : TPE (UL 94V-0 is optional)
G:Hardness is Shore A45 H: Hardness is Shore A55
- ◆ COLOR : BLACK/BLUE
- ◆ UNIT: mm

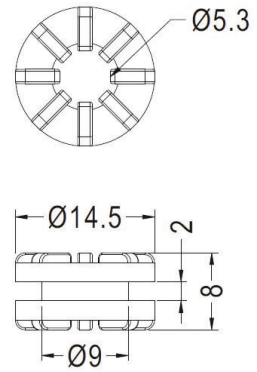
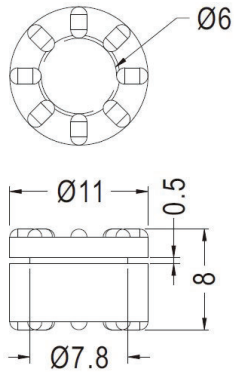
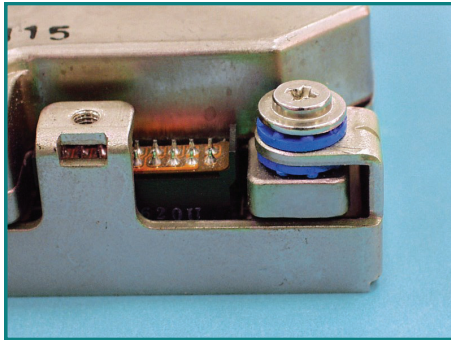

PART NO	PACKAGE
LTGM20	1000

PART NO	PACKAGE
LTGM22	1000

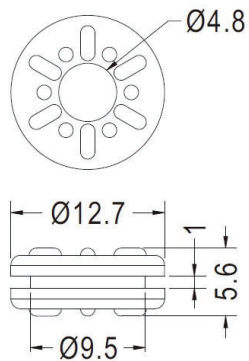
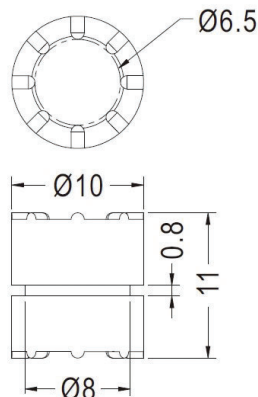
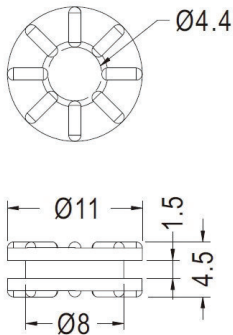

• Material: Silicon Rubber

PART NO	PACKAGE
LTGM08	1000

PART NO	PACKAGE
LTGM23	1000

PART NO	PACKAGE
LTGM31	1000

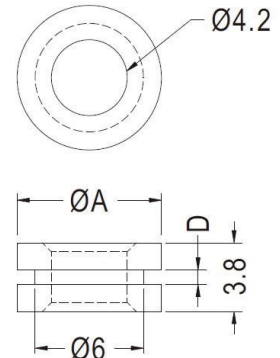
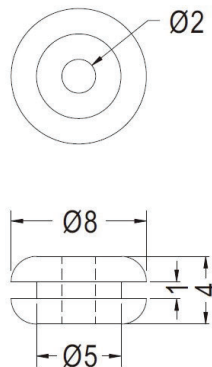
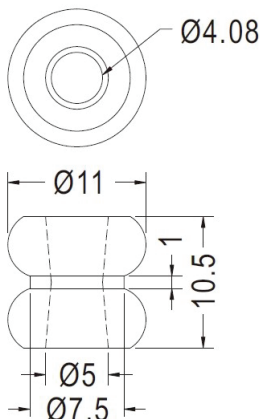

PART NO	PACKAGE
LTGM29	1000

PART NO	PACKAGE
LTGM102	1000

PART NO	A	D	PACK-AGE
LTGM19	8.0	0.8	1000
LTGM103	8.1	1.1	1000

抗震线环 ANTI-VIBRATION GROMMET 防震线环

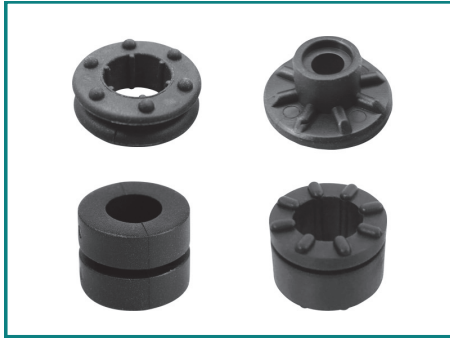

用途： 抗震线环，也称防震线环，用于硬盘及精密零件之防震。
G: 为45度硬度， H: 为55度硬度

- ◆ MATERIAL : TPE (UL 94V-0 is optional)
G:Hardness is Shore A45 H: Hardness is Shore A55
- ◆ COLOR : BLACK/BLUE
- ◆ UNIT: mm

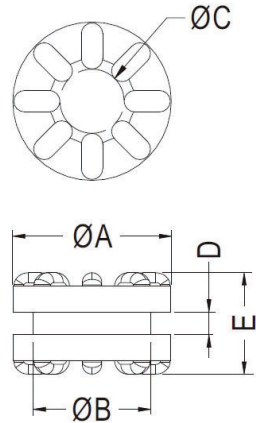
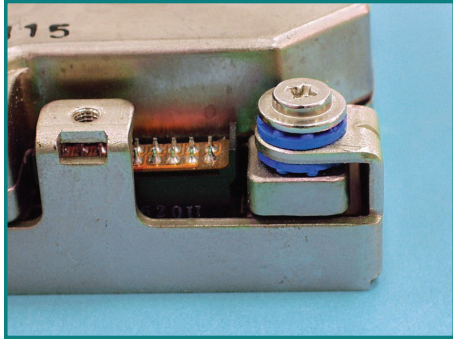

LTGM14可配合GPEK-06螺絲用
LTGM16可配合GPEK-04螺絲用

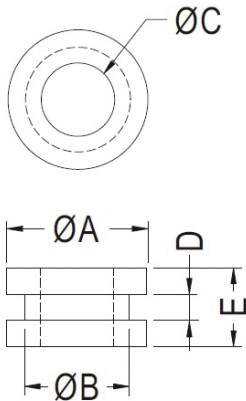

PART NO	A	B	C	D	E	PACKAGE
LTGM11	12.0	9.0	6.0	1.0	9.0	1000
LTGM12	8.0	6.0	4.2	1.5	4.6	1000
LTGM61	10.0	7.0	5.0	2.0	5.0	1000
LTGM79	8.8	6.6	3.6	0.8	3.8	1000
LTGM92	8.8	6.0	4.2	0.9	2.9	1000
LTGM93	8.0	6.0	4.2	0.9	2.9	1000
LTGM94	9.6	7.6	5.6	0.8	2.8	1000
LTGM95	6.5	5.0	4.0	1.0	3.8	1000
LTGM104	7.5	5.8	3.1	0.9	2.8	1000
LTGM105	24.0	18.0	14.0	3.0	7.0	1000

PART NO	A	B	C	D	E	PACKAGE
LTGM09	9.62	6.3	3.9	1.0	5.8	1000
LTGM10	9.62	6.35	3.9	0.8	5.8	1000
LTGM14	10.5	7.8	4.75	1.5	6.75	1000
LTGM15	11.0	7.8	4.75	1.0	8.0	1000
LTGM16	9.62	6.3	3.9	1.6	5.8	1000
LTGM17	9.62	6.3	3.9	3.0	7.0	1000
LTGM18	9.62	6.3	3.9	1.2	5.8	1000
LTGM21	12.0	9.0	6.0	1.0	9.0	2000
LTGM35	9.5	7.0	4.3	2.6	6.6	1000
LTGM56	19.0	13.8	9.0	3.0	10.2	1000
LTGM80	9.0	6.0	4.0	1.3	3.7	1000
LTGM96	9.2	6.5	4.1	1.0	4.6	1000
LTGM97	7.8	6.0	4.0	1.1	4.5	1000
LTGM99	10.5	7.8	4.75	2.0	7.25	1000
LTGM100	8.0	5.5	3.9	0.8	3.4	1000
LTGM110	7.0	5.5	3.9	1.0	5.8	1000

抗震线环 ANTI-VIBRATION GROMMET 防震线环



用途： 抗震线环，也称防震线环，用于硬盘及精密零件之防震。

G: 为45度硬度, H: 为55度硬度

- ◆ MATERIAL : TPE (UL 94V-0 is optional)
G:Hardness is Shore A45 H: Hardness is Shore A55
- ◆ COLOR : BLACK/BLUE
- ◆ UNIT: mm

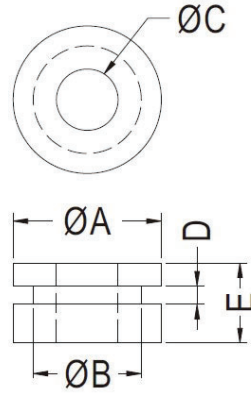
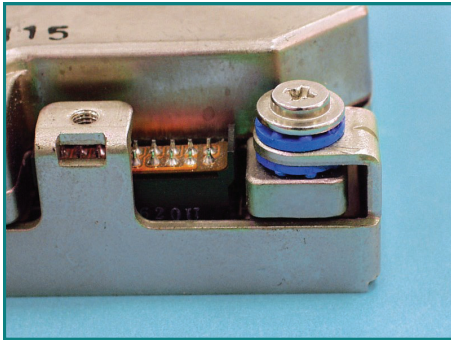

PART NO	A	B	C	D	E	PACKAGE
LTGM24	7.0	5.5	4.0	0.6	5.5	1000
LTGM58	9.6	7.0	4.0	1.2	5.2	1000
LTGM59	8.0	6.0	4.2	0.8	2.9	1000

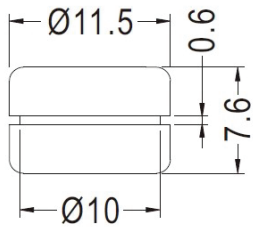
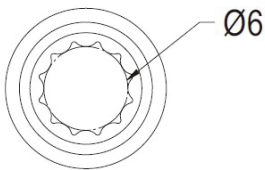

PART NO	PACKAGE
LTGM26	1000

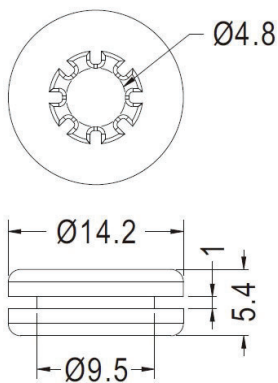
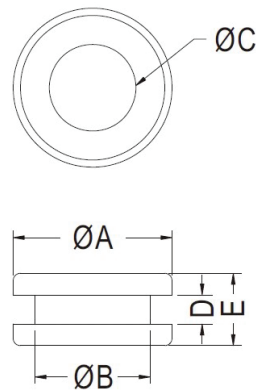

PART NO	PACKAGE
LTGM32	1000

PART NO	A	B	C	D	E	PACKAGE
LTGM27	11.0	8.0	6.0	2.0	5.0	1000
LTGM28	12.7	9.5	4.8	1.6	5.4	1000
LTGM30	7.0	5.5	3.9	0.9	2.8	1000
LTGM34	14.2	9.5	4.9	1.0	4.9	1000
LTGM81	14.2	9.5	5.4	1.0	4.9	1000
LTGM98	8.6	7.0	5.5	0.8	7.8	1000
LTGM106	8.8	6.8	4.85	1.2	4.0	1000

抗震线环 ANTI-VIBRATION GROMMET 防震线环

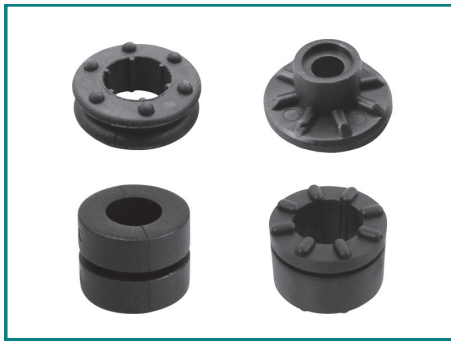

用途： 抗震线环，也称防震线环，用于硬盘及精密零件之防震。

G: 为45度硬度, H: 为55度硬度

- ◆ MATERIAL : TPE (UL 94V-0 is optional)
G: Hardness is Shore A45 H: Hardness is Shore A55
- ◆ COLOR : BLACK/BLUE
- ◆ UNIT: mm

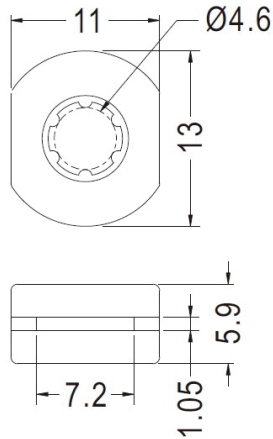
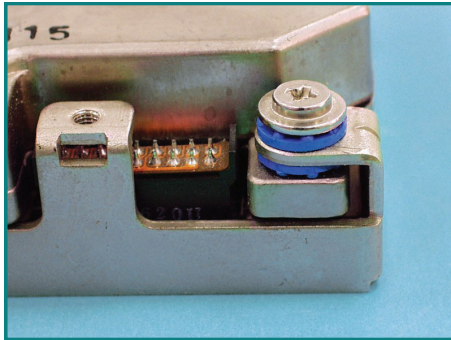

PART NO	PACKAGE
LTGM107	1000

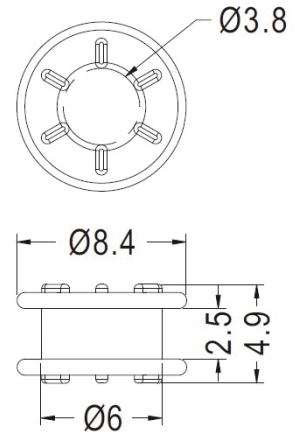

PART NO	PACKAGE
LTGM57	1000

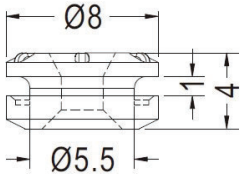
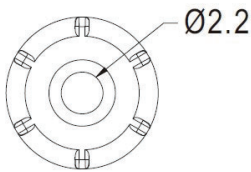

Material: Silicon Rubber

PART NO	PACKAGE
LTGM33	1000

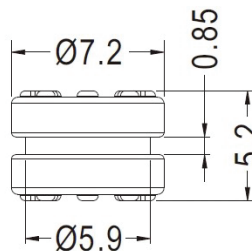
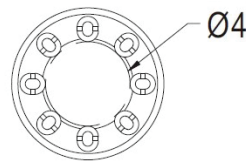

PART NO	PACKAGE
LTGM101	1000

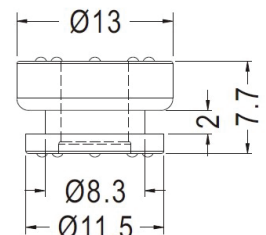
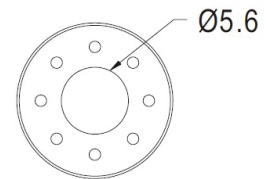

PART NO	PACKAGE
LTGM88	1000

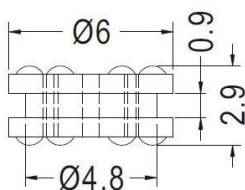
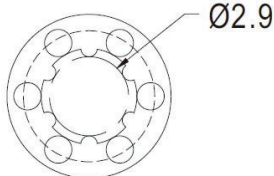

Material: Silicon Rubber

PART NO	PACKAGE
LTGM83	1000

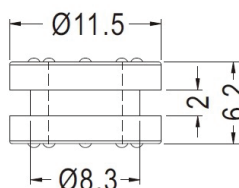
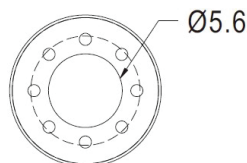

PART NO	PACKAGE
LTGM90	1000

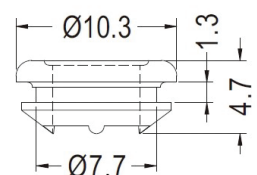
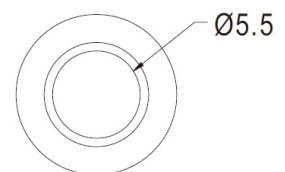

PART NO	PACKAGE
LTGM75	1000

抗震线环 ANTI-VIBRATION GROMMET 防震线环

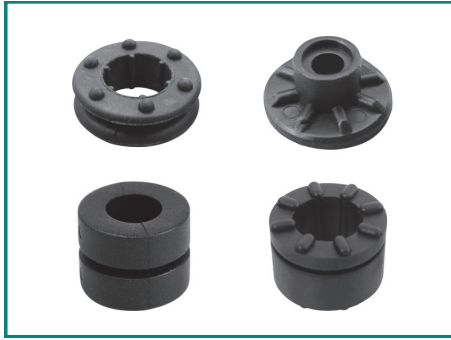

用途： 抗震线环，也称防震线环，用于硬盘及精密零件之防震。

G: 为45度硬度，H: 为55度硬度

- ◆ MATERIAL : TPE (UL 94V-0 is optional)
G:Hardness is Shore A45 H: Hardness is Shore A55
- ◆ COLOR : BLACK/BLUE
- ◆ UNIT: mm

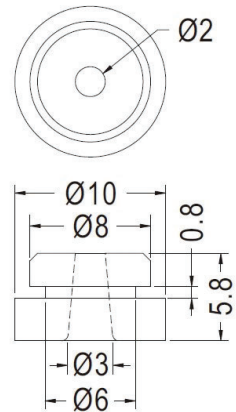
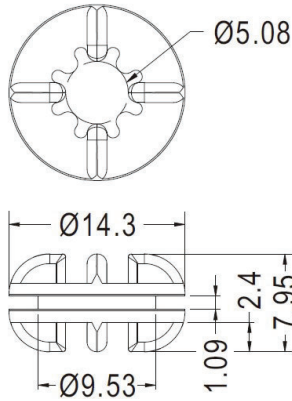
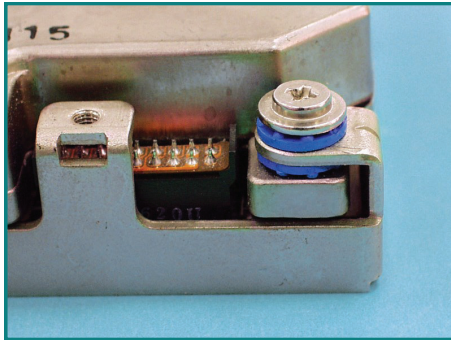

PART NO	PACKAGE
LTGM89	1000

PART NO	PACKAGE
LTGM25	1000

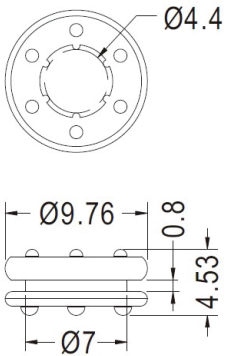

MOUNTING HOLE Ø7.0~Ø7.5

PART NO	PACKAGE
LTGM38	1000

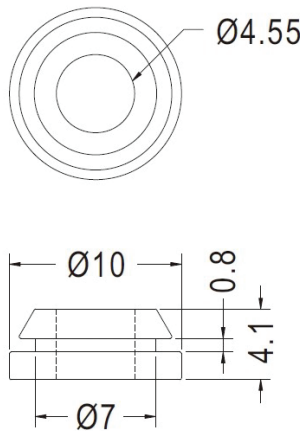

PART NO	PACKAGE
LTGM108	1000

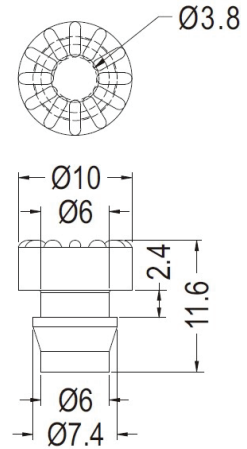

PART NO	PACKAGE
LTGM87	1000

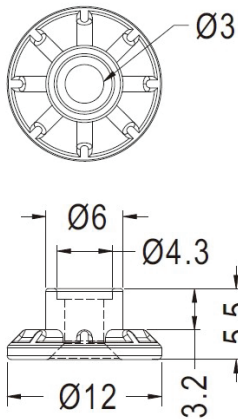

MOUNTING HOLE Ø6.0

PART NO	PACKAGE
LTGM41	1000

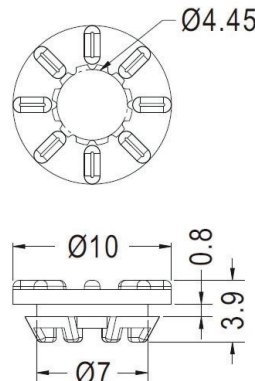

PART NO	PACKAGE
LTGM60	1000

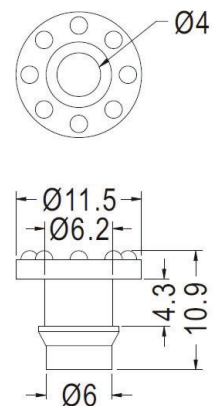

PART NO	PACKAGE
LTGM91	1000

抗震线环 ANTI-VIBRATION GROMMET 防震线环



用途： 抗震线环，也称防震线环，用于硬盘及精密零件之防震。

- ◆ MATERIAL : NBR/RUBBER/SILICON RUBBER
- ◆ COLOR : BLACK
- ◆ UNIT: mm

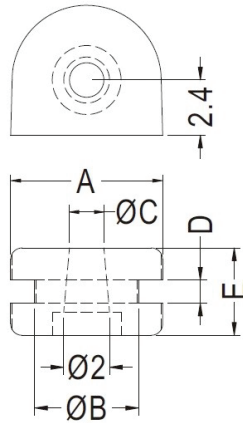

LTGM43

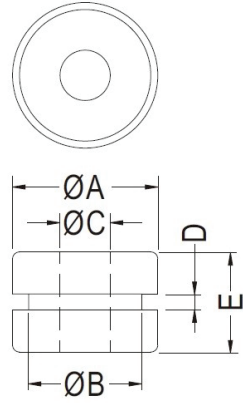

LTGM44
LTGM46

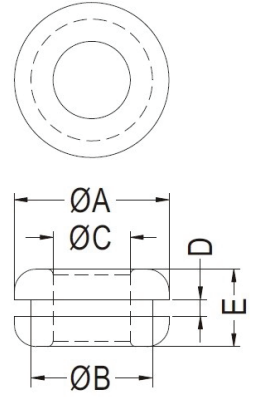

LTGM45

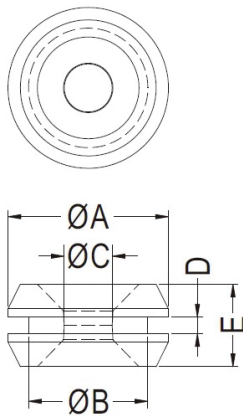

LTGM47

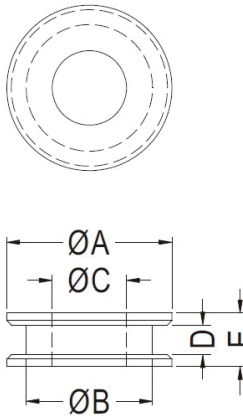

LTGM48

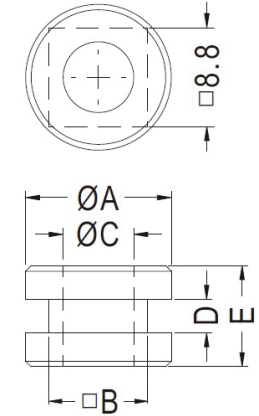

LTGM84

PART NO	A	B	C	D	E	PACKAGE
LTGM43	6.63	4.52	1.5	1.0	3.8	1000
LTGM44	8.0	6.0	4.1	1.1	3.4	2000
LTGM45	14.0	11.0	7.0	1.5	7.0	1000
LTGM46	12.0	9.0	6.0	1.0	9.0	1000
LTGM47	7.8	5.8	2.33	1.2	4.0	1000
LTGM48	11.1	8.5	5.0	2.0	3.6	1000
LTGM84	13.0	8.8	6.3	3.0	9.0	1000

抗震线环 ANTI-VIBRATION GROMMET 防震线环



用途： 抗震线环，也称防震线环，用于硬盘及精密零件之防震。

- ◆ MATERIAL : NBR/RUBBER/SILICON RUBBER
- ◆ COLOR : BLACK
- ◆ UNIT: mm

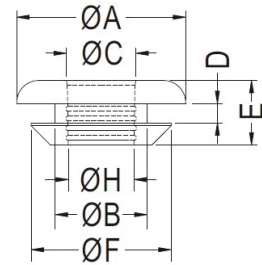
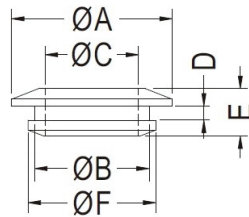
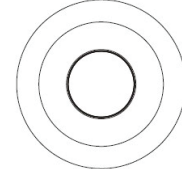
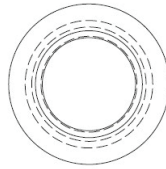

LTGM73

PART NO	A	B	C	D	E	F	H	PACKAGE
LTGM49	17.5	9.5	7.2	2.0	6.7	14.5	6.8	1000
LTGM50	17.5	9.5	6.8	2.0	6.7	14.5	6.3	1000
LTGM51	18.5	10.5	8.2	2.0	6.7	15.5	7.8	1000
LTGM52	19.5	11.5	9.2	2.0	6.7	16.5	8.8	1000
LTGM53	17.5	9.5	6.2	2.0	6.7	14.5	5.8	1000
LTGM54	17.5	11.5	7.2	2.0	6.7	16.5	6.8	1000
LTGM55	17.5	11.5	7.6	2.0	6.7	16.5	7.2	1000
LTGM73	12.0	8.5	6.7	1.1	3.6	9.5	-	2000
LTGM85	21.8	13.8	11.2	2.0	6.7	18.8	10.8	1000

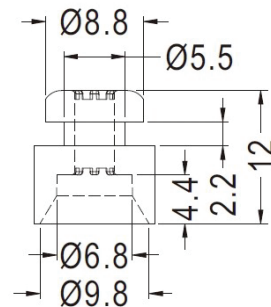
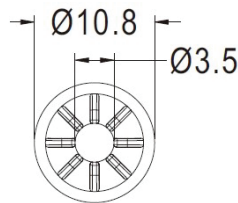

PART NO	PACKAGE
LTGM42	1000

抗震线环 ANTI-VIBRATION GROMMET 防震线环



用途： 抗震线环，也称防震线环，用于硬盘及精密零件之防震。

- ◆ MATERIAL : NBR/RUBBER/SILICON RUBBER
- ◆ COLOR : BLACK
- ◆ UNIT: mm

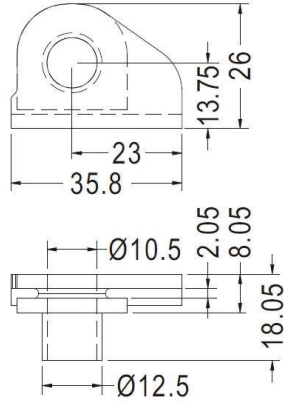

PART NO	PACKAGE
LTGM64	1000

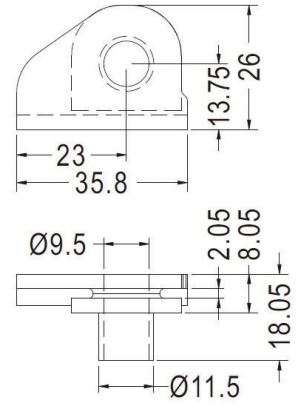

PART NO	PACKAGE
LTGM65	1000

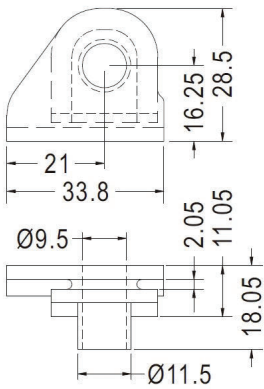

PART NO	PACKAGE
LTGM66	1000

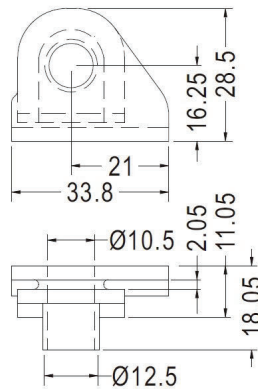

PART NO	PACKAGE
LTGM67	1000

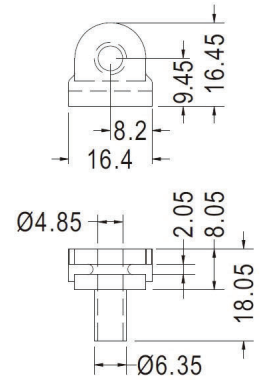

PART NO	PACKAGE
LTGM68	1000

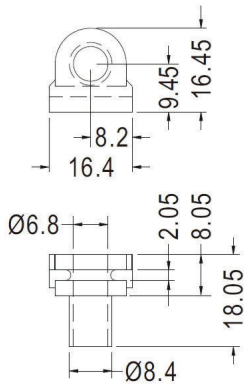

PART NO	PACKAGE
LTGM69	1000

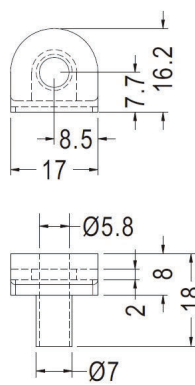

PART NO	PACKAGE
LTGM70	1000

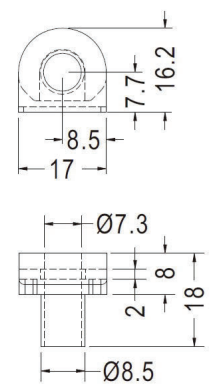

PART NO	PACKAGE
LTGM71	1000

抗震线环 ANTI-VIBRATION GROMMET 防震线环



用途： 抗震线环，也称防震线环，用于硬盘及精密零件之防震。

- ◆ MATERIAL : TPR
- ◆ COLOR : BLACK
- ◆ UNIT: mm

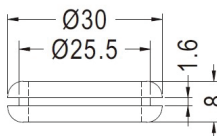
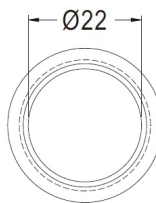

PART NO	PACKAGE
LTGM72	250

抗震线环(含Pin) ANTI-VIBRATION GROMMET WITH PIN 防震线环



用途： 抗震线环，也称防震线环，用于硬盘及精密零件之防震。

- ◆ BODY MATERIAL : TPE
- ◆ PIN MATERIAL : ZINC PLATED STEEL
- ◆ COLOR : BLACK / BLUE
- ◆ UNIT: mm

装配孔尺寸，仅供参考
Mounting holes are for reference only.

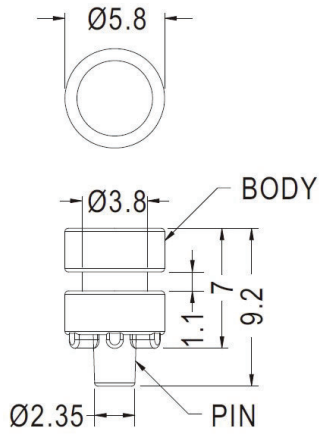

FOR TGM-117
PIN

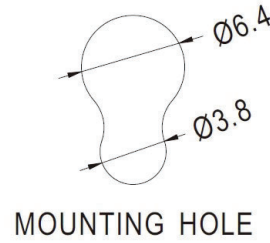

PART NO	PACKAGE
LTGM39	1000
LTGM78	1000

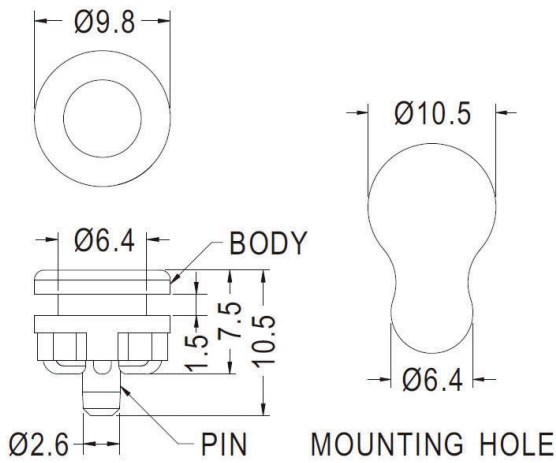

PART NO	PACKAGE
LTGM40	1000

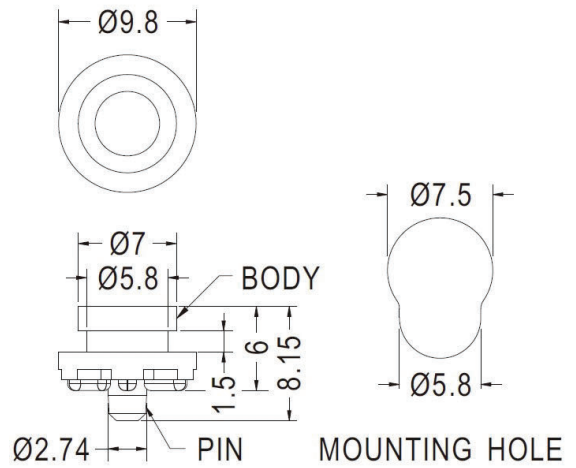

PART NO	PACKAGE
LTGM63	1000

抗震线环(含Pin) ANTI-VIBRATION GROMMET WITH PIN 防震线环



用途： 抗震线环，也称防震线环，用于硬盘及精密零件之防震。

- ◆ BODY MATERIAL : TPE
- ◆ PIN MATERIAL : ZINC PLATED STEEL
- ◆ COLOR : BLACK / BLUE
- ◆ UNIT: mm

装配孔尺寸，仅供参考
Mounting holes are for reference only.

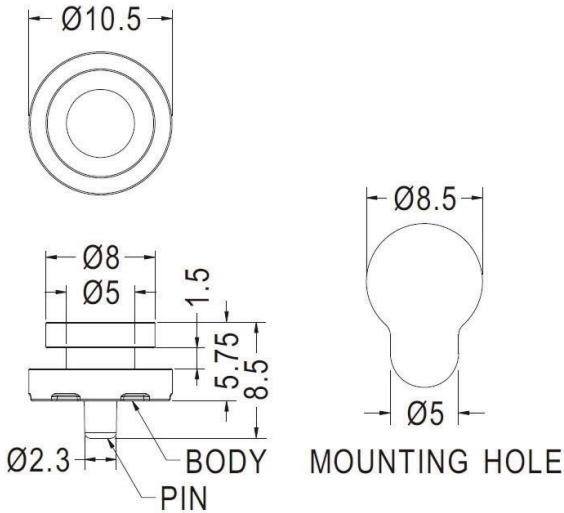

PART NO	PACKAGE
LTGM77	1000

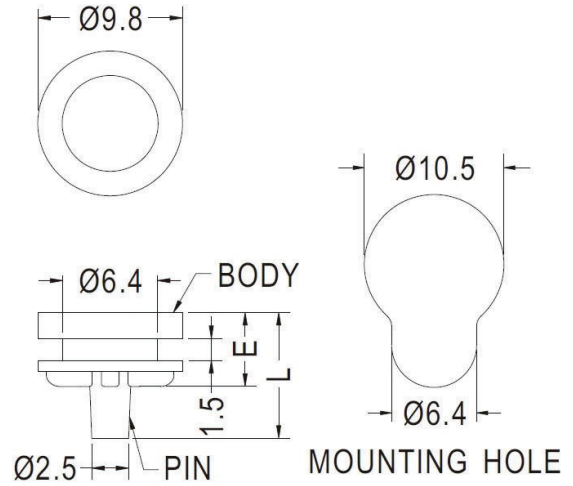

PART NO	E	L	PACKAGE
LTGM36	5.0	8.5	1000
LTGM62	5.5	9.0	1000

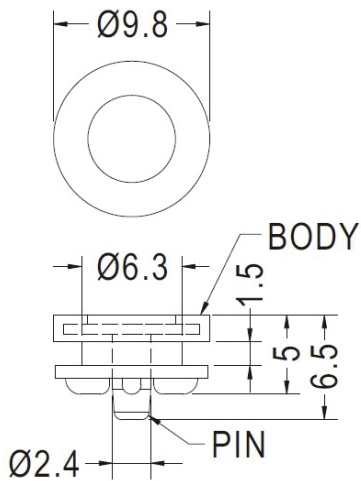

MOUNTING HOLE Ø6.4
THICKNESS 1.0~1.5

PART NO	PACKAGE
LTGM109	1000

抗震线环(含Pin) ANTI-VIBRATION GROMMET WITH PIN 防震线环



用途： 抗震线环，也称防震线环，用于硬盘及精密零件之防震。

G: 为45度硬度， H: 为55度硬度

- ◆ MATERIAL : TPE (UL 94V-0 is optional)
G:Hardness is Shore A45 H: Hardness is Shore A55
- ◆ PIN MATERIAL : ZINC PLATED STEEL
- ◆ COLOR : BLACK
- ◆ UNIT: mm

装配孔尺寸，仅供参考
Mounting holes are for reference only.

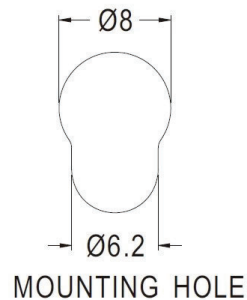
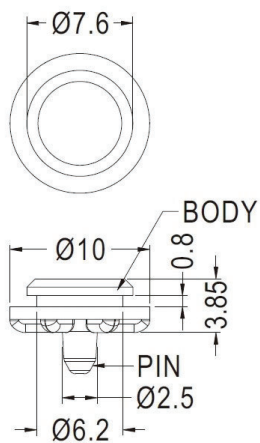

PART NO	PACKAGE
LTGM74	1000

抗震线环(含螺丝) ANTI-VIBRATION GROMMET WITH SCREW 防震线环



用途： 抗震线环，也称防震线环，用于硬盘及精密零件之防震。

- ◆ BODY MATERIAL : TPE
- ◆ PIN MATERIAL : ZINC PLATED STEEL
- ◆ COLOR : BLACK / BLUE
- ◆ UNIT: mm

装配孔尺寸，仅供参考

Mounting holes are for reference only.

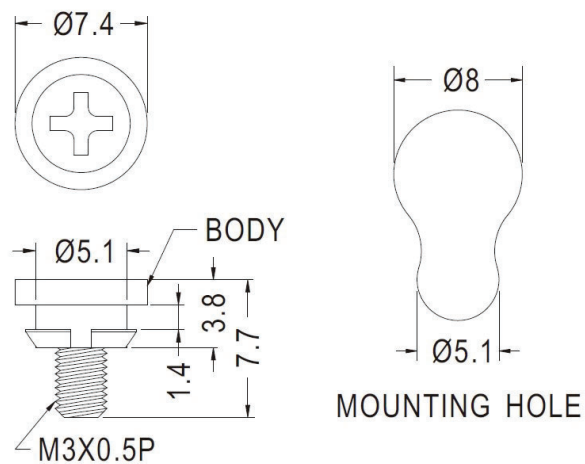

PART NO	PACKAGE
LTGM37	1000

抗震线环用插销 PIN FOR ANTI-VIBRATION GROMMET 防震线环



- ◆ MATERIAL : PC (UL)
- ◆ FLAME CLASS : 94V-0
- ◆ COLOR : BLACK
- ◆ UNIT: mm

用途：抗震线环用插销，硬盘及精密零件之抗震线环用插销，可配抗震线环使用。

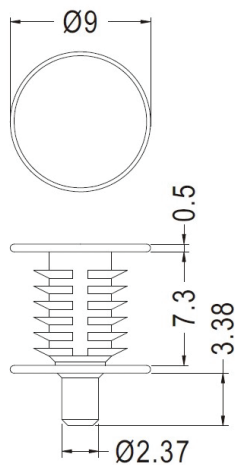

配抗震線環LTGM82使用

PART NO	PACKAGE
CX-1	1000

抗震线环用螺丝 SCREW FOR ANTI-VIBRATION GROMMET 防震线环 螺丝



- ◆ MATERIAL : STEEL
- ◆ FINISH : NICKEL PLATING
- ◆ UNIT: mm

用途：抗震线环用螺丝，硬盘及精密零件之抗震线环用螺丝，可配抗震线环使用。

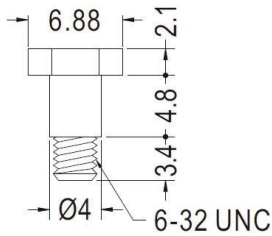
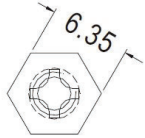
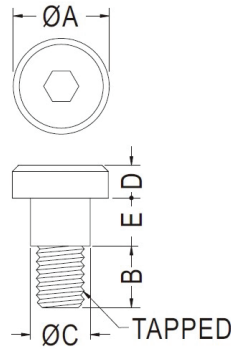

可配抗震線環LTGM16使用

PART NO	PACKAGE
GPEK-04	1000

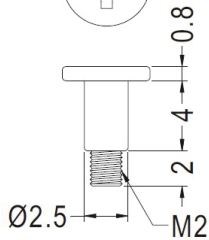
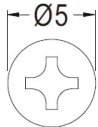

可配抗震線環LTGM13使用

PART NO	PACKAGE
GPEK-05	1000

PART NO	A	B	C	D	E	TAPPED	PACKAGE
GPEK-01	6.0	4.0	4.0	3.0	4.01	M3X0.5	1000
GPEK-02	8.0	5.15	5.0	2.7	4.01	M4X0.7	1000
GPEK-03	8.0	7.25	5.0	2.7	4.01	M4X0.7	1000

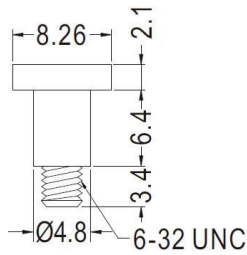
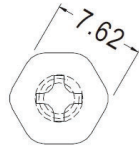

可配抗震線環LTGM14使用

PART NO	PACKAGE
GPEK-06	1000

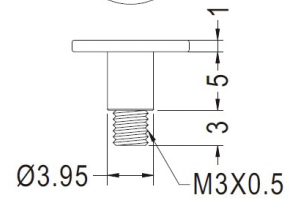
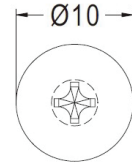

可配抗震線環LTGM16使用

PART NO	PACKAGE
GPEK-10	1000

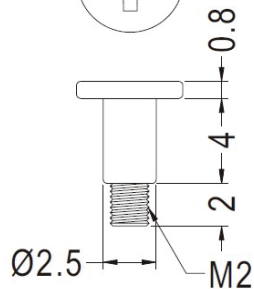
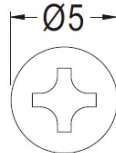

可配抗震線環LTGM13使用

PART NO	PACKAGE
GPEK-32	1000

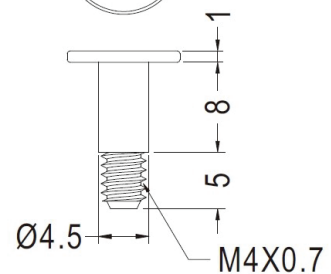
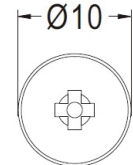

PART NO	PACKAGE
GPEK-31	1000

抗震线环用螺丝 SCREW FOR ANTI-VIBRATION GROMMET 防震线环 螺丝



- ◆ MATERIAL : STEEL
- ◆ FINISH : NICKEL PLATING
- ◆ UNIT: mm

用途：抗震线环用螺丝，硬盘及精密零件之抗震线环用螺丝，可配抗震线环使用。

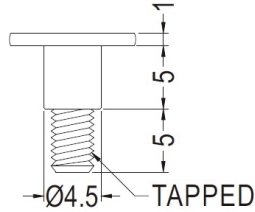
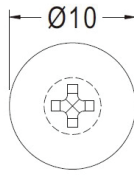

可配抗震線環LTGM06使用



PART NO	TAPPED	PACKAGE
GPEK-08	M3X0.5	1000
GPEK-09	6-32 UNC	1000

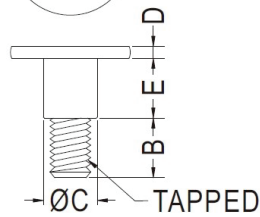
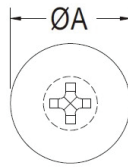

PART NO	A	B	C	D	E	TAPPED	PACKAGE
GPEK-07	10.0	3.4	4.8	1.0	6.4	M3X0.5	1000

磁盘驱动器防震座 HDD Anti-Vibration Base

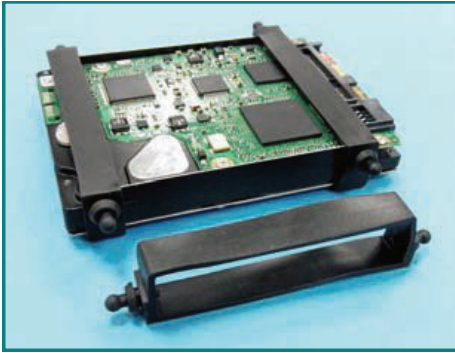

- ◆ MATERIAL : TPE
- ◆ COLOR : BLACK
- ◆ UNIT: mm

用途：磁盘驱动器防震座，用于硬盘及精密零件之防震。

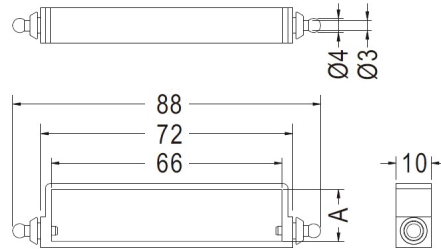

PART NO	A	HDD	PACKAGE
DKH-1	14.8	3.5"	100
DKH-2	6.7	2.5"	100
DKH-3	9.3	2.5"	100

透气压力平衡固定头 Pressure Balance Gland



- ◆ MATERIAL : A=NYLON 66(UL)
B=EPDM C,D=PC(UL)
- ◆ FLAME CLASS : 94V-2/ 94V-0
- ◆ COLOR : NATURAL / BLACK
- ◆ UNIT: mm

用途： 透气压力平衡固定头，用于机器之透气和防水。

- ✓ 通过IP68防水测试
- ✓ 典型透氧量1.11ml/分钟 (压差20mbar)

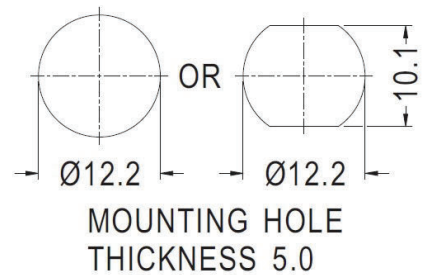
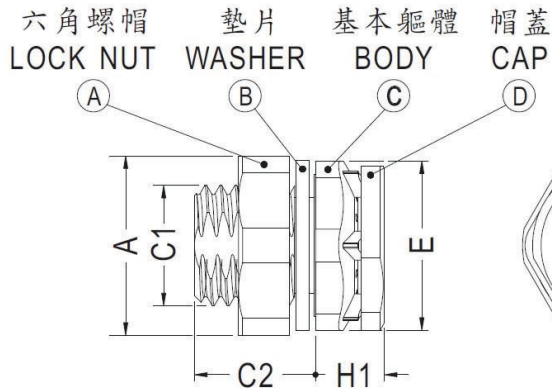

PART NO	标准螺牙 THREADED ENTRY METRIC C1	螺纹长度 THREADED LENGTH C2	高度 HEIGHT H1	扳手径 SPANNER SIZE A&E	PACKAGE
MOR-1	M12X1.5P	12.0	7.0	18/17	500

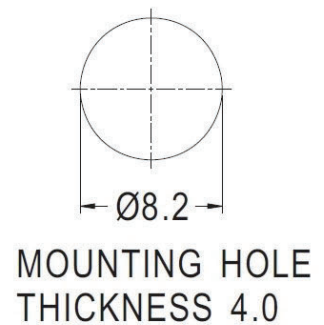
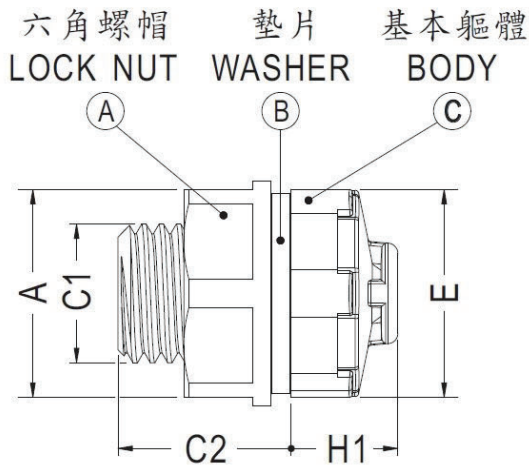

PART NO	标准螺牙 THREADED ENTRY METRIC C1	螺纹长度 THREADED LENGTH C2	高度 HEIGHT H1	扳手径 SPANNER SIZE A&E	PACKAGE
MOR-2	M8X1P	10.0	6.15	12&12	500

透气压力平衡固定扣 Pressure Balance Fastener



- ◆ MATERIAL : A,B=PC (UL)
C=SILICON RUBBER
- ◆ FLAME CLASS : 94V-0
- ◆ COLOR : BLACK
- ◆ UNIT: mm

用途： 透气压力平衡固定扣，用于机器之透气和防水。

- ✓ 通過IP68防水測試
- ✓ 典型透氣量1.11ml/分鐘 (壓差20mbar)

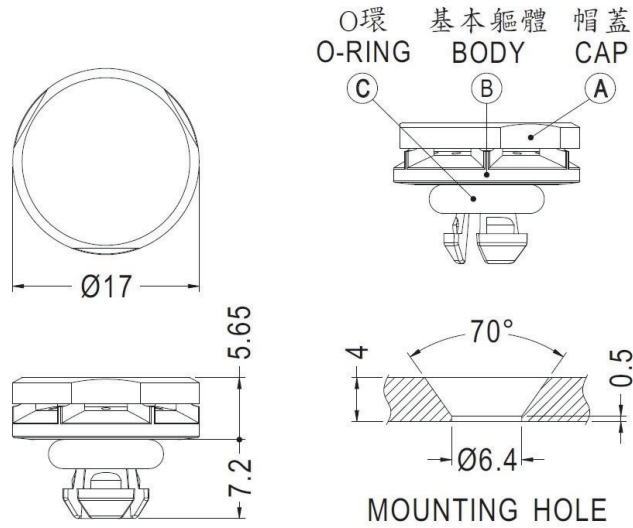

PART NO	PACKAGE
MOR-3	500

电子电脑塑胶五金零件目录

1.LED间隔柱

2.LED导光柱 LED导光盖 LED遮光罩

3.LED座 LED座套 红外线灯罩 光纤座

4.90°LED灯座 45°LED灯座

5. PC板间隔柱 PC板隔离柱

6. 塑料铜柱 尼龙柱 六角隔离柱 塑胶铜柱 铜柱 导光板隔离柱 圆体间隔柱 PC板固定定座 固定扣 电路板隔离柱 导电隔离柱

7. 排线固定座 自粘式配线固定座 排线固定夹 压线板 电线固定座 扭线固定座 扭式固定环 扎线固定座 电源线固定座 电源线固定座插头固定扣 天线固定座 T8灯管固定座 风扇束线座 光纤固定座

8. PC板端子 接线插片端子 PC板焊接端子 接地片 圆形连接片 弹片 测试针 探针 测试点 保险丝座 保险丝盖 插式电线连接头 闭端端子 弹簧螺纹端子 压线帽 端子台 快速接线夹 跳线

9. 仪表脚垫 插销式脚垫 螺丝固定脚垫 脚垫 抗震脚垫 磁铁脚垫 橡胶脚垫 自粘脚垫 银框脚垫 金框脚垫 橡胶垫圈 橡胶华司 橡胶垫片 硅胶脚垫

10. 塑料螺丝 塑胶螺丝 翼型塑料螺丝 塑料螺帽 塑料螺帽 蝶形螺母 止付螺丝 紧定螺钉 内牙螺丝 螺丝帽盖 手转螺丝 手拧螺丝 滚花螺丝 手转螺母 手拧螺母

11. PC板拉柄 PC板耳把 PC板导槽 电路板导轨 PCB导轨槽 直立式导槽 电路板导轨

12. 晶体管盖 电晶体盖 晶体管垫片 电晶体垫片 晶体管座 电晶体座 T-O3晶体管座 石英晶体垫片 垫圈 华司 垫片 TO-220晶体管座 光电晶体座 电晶体座 IR晶体座 霍尔晶体座 硅胶帽套 功率晶体导热硅片 功率晶体压板 电源固定压条 晶体管固定弹片 五金弹片 电晶体固定弹片 晶体管夹

电子电脑塑胶五金零件目录

13.电容器垫片 垫圈 华司 电容器座 电容器帽套 电容器固定座 电容器盖 电容器护套 压敏护套 硅胶帽套

14.热敏电阻座 电阻保护座 保护电阻器 可变电阻盖

15.陶瓷零件垫片 零件垫片 垫圈 华司 零件垫座 IC座 桥式整流座 跳线座 线圈座 滤波器垫片 绝缘柱 螺丝垫片 滚轮 PC板垫片 球击缓冲垫片 尼龙垫圈 尼龙弹簧垫片 散热陶瓷垫片

16.功率IC盖 桥式整流盖 保护盖 开关盖 硅胶盖 绝缘盖 电池盖 末端套管 软质端子保护套PC端子保护套 喇叭座 拉柄箱扣 线圈固定座 DRAM固定带 十字型插件式固定器 轨道固定器

17.孔塞 扣式孔塞 扣式塞头 DVI防尘盖 螺丝孔孔塞 螺丝塞头 螺纹孔塞

18.电源线扣 电线固定夹 护线环 橡胶圈 护线圈 开口式护线环 橡胶线环 硅胶线环 硅胶护线环 天线护线环 方型护线环 U型护线环 抗震护线环 防震线环 抗震线环用插销 抗震线环用螺丝 硬盘驱动器防震座 透气压力平衡固定头 透气平衡压力固定扣

19.把手 机箱把手 仪器门拉手 纸箱把手 纸箱配件 打包扣 外箱护脚垫 纸箱外箱扣

20.阻尼齿轮 阻尼器 缓冲齿轮

21.电线扎带 电线束线带 固定带 扎线 电源线收线带 珠型扎带 水管座 扎带座 扎带扣 吊勾粘扣带 绑线带

22.USB座护盖 USB端口保护盖 USB端口防尘盖 MICRO USB防尘盖 MINI USB座护盖USB Type-C防尘盖 USB防尘盖 RJ-45防尘盖 RJ-11防尘盖 RJ-12防尘盖 RJ-22防尘盖 电源插头防尘盖 电源插头保护座 电源插头防尘座 电源插头防尘盖 光纤连接器护盖 光纤连接器护套 光纤防尘盖 PC板金手指防尘盖 HDMI防尘盖 Mini数位端子防尘盖 汽车点烟器防尘盖BBU防尘盖 DVI防尘盖 连接器盖 SIM Card Cap防尘盖 SD防尘盖 KVM防尘盖 CF防尘盖 防尘盖 端子盖 S端子盖 平衡端子盖 BNC绝缘座 SATA防尘盖 ESATA护盖 DP端子防尘盖 Mini D.P数位端子防尘盖 D.Type防尘盖 VGA防尘盖 IDE Connector防尘盖 PC端子防尘盖 端子防尘盖 1394端子防尘盖 零件盖 电源盖 机板电源保护盖 连接器座 PCMIC卡保护盖 面板 DDR防尘盖 D-Sub保护盖 高压防尘盖 SD保护盖 Micoro SD卡保护盖 SIM卡保护盖 防水帽盖 帽盖连接带 防水圈 电脑风扇防护盖 电脑风扇防尘座 电脑风扇框护垫 电脑风扇支架 开关遮板 光纤晶体座

电子电脑塑胶五金零件目录

23.插销 铆钉 尼龙铆钉 螺丝铆钉 散热片铆钉 塑料铆钉 电脑风扇铆钉 散热片扣件 弹簧铆钉 螺丝固定座 膨胀螺栓 墙塞 无帽鱼型膨胀管 墙面固定座 石膏板固定座

24.固定扣 门扣开关 机器门扣开关 弹簧固定座 旋转型门扣 门扣碰珠 磁铁门扣

55.工具 线扣工具 进口束线枪 旗型端子工具 国产束线枪 非绝缘端子工具 绝缘端子工具



电子电脑塑胶五金零件目录



1.LED间隔柱



2.LED导光柱



3.LED座



4.90°LED灯座



5.PC板间隔柱



6.塑料铜柱



7.排线固定座



8.PC板端子



9.仪表脚垫



10.塑料螺丝



11.PC板拉柄导槽



12.晶体管盖



13.电容器垫片



14.热敏电阻座



15.陶瓷零件垫片



16.功率IC盖



电子电脑塑胶五金零件目录



17.孔塞



18.电源线扣



19.机箱把手



20.阻尼齿轮



21.电线扎带



22.USB座护盖



23.尼龙铆钉



24.门扣开关



55.工具

电子电脑塑胶五金零件

PLASTIC HARDWARE & ELECTRONIC COMPONENTS



南京诺金电气有限公司
Nanjing Nojinqing Electric Co., Ltd.

2023.03/2024

选型手册总目录

本公司保留因质量改进、后续开发或生产要求引起的设计更改权力。本产品目录为元件的详细说明，不能做担保依据。使用者有义务审核该元件是否符合应用范围的规定。



微信



QQ

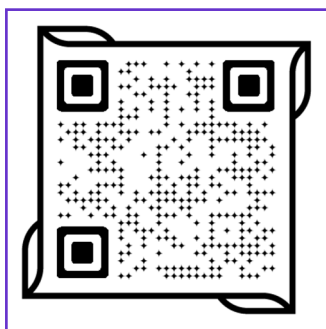

网站

南京诺金电气有限公司

Nanjing Nowking Electric Co., Ltd

- ◆ Tel: 025-85422485 85436028 85437901
- ◆ Wechat/Mobile :13770725488
- ◆ QQ:260678075
- ◆ E-mail: nk@nowking.com
- ◆ [Http://www.nowking.com](http://www.nowking.com)
- ◆ [Http://www.kyphe.com](http://www.kyphe.com)