

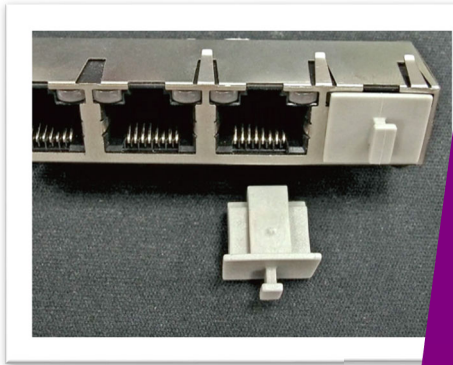

USB座护盖

USB PORT COVER



RJ-45防尘盖

RJ45 Port Cover



电源插座防尘盖

Power Connector Cover



光纤连接器护套

Fiber Optic Connector Cover

电子电脑塑胶五金零件

PLASTIC HARDWARE& ELECTRONIC COMPONENTS

2023 EDITON

USB座护盖 电源插头防尘盖 RJ防尘盖 光纤保护盖 PC板金手指防尘盖 HDMI防尘盖 DVI防尘盖 KVM防尘盖 CF防尘盖 防尘盖 端子盖 S端子盖 平衡端子盖 BNC绝缘座 SATA防尘盖 ESATA护盖 DP端子防尘盖 1394端子防尘盖 D.Type防尘盖 VGA防尘盖 IDE Connector防尘盖 PC端子防尘盖 电脑风扇防护 光纤晶体座

USB座护盖 USB端口保护盖 USB端口防尘盖 MICRO USB防尘盖 MINI USB座护盖 USB Type-C防尘盖 USB防尘盖 RJ-45防尘盖 RJ-11防尘盖 RJ-12防尘盖 RJ-22防尘盖 电源插头防尘盖 电源插头保护座 电源插头防尘座 电源插头防尘盖 光纤连接器护盖 光纤连接器护套 光纤防尘盖 PC板金手指防尘盖 HDMI防尘盖 Mini数位端子防尘盖 汽车点烟器防尘盖 BBU防尘盖 DVI防尘盖 连接器盖 SIM Card Cap防尘盖 SD防尘盖 KVM防尘盖 CF防尘盖 防尘盖 端子盖 S端子盖 平衡端子盖 BNC绝缘座 SATA防尘盖 ESATA护盖 DP端子防尘盖 Mini D.P 数位端子防尘盖 D.Type防尘盖 VGA防尘盖 IDE Connector防尘盖 PC端子防尘盖 端子防尘盖 1394端子防尘盖 零件盖 电源盖 机板电源保护盖 连接器座 PCMIC卡保护盖 面板 DDR防尘盖 D-Sub保护盖 高压防尘盖 SD保护盖 Micoro SD卡保护盖 SIM卡保护盖 防水帽盖 帽盖 连接带 防水圈 电脑风扇防护盖 电脑风扇防尘座 电脑风扇框护垫 电脑风扇支架 开关遮板 光纤晶体座

USB座护盖 电源插头防尘盖 RJ防尘盖 光纤保护盖 PC板金手指防尘盖 HDMI防尘盖 DVI防尘盖 KVM防尘盖 CF防尘盖 防尘盖 端子盖 S端子盖 平衡端子盖 BNC绝缘座 SATA防尘盖 ESATA护盖 DP端子防尘盖 1394端子防尘盖 D.Type防尘盖 VGA防尘盖 IDE Connector防尘盖 PC端子防尘盖 电脑风扇防护 光纤晶体座

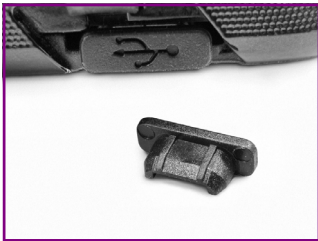
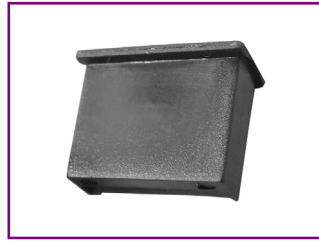
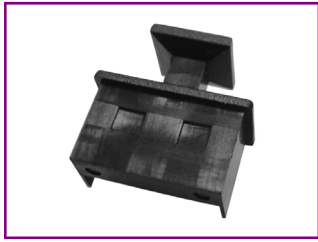
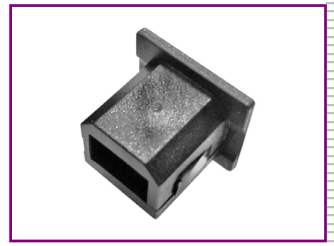
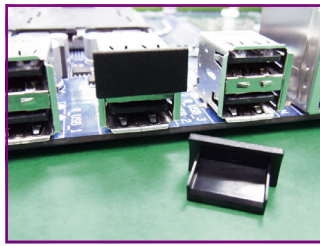

USB座护盖 电源插头防尘盖 RJ防尘盖 光纤保护盖 PC板金手指防尘盖 HDMI防尘盖 DVI防尘盖 KVM防尘盖 CF防尘盖 防尘盖 端子盖 S端子盖 平衡端子盖 BNC绝缘座 SATA防尘盖 ESATA护盖 DP端子防尘盖 1394端子防尘盖 D.Type防尘盖 VGA防尘盖 IDE Connector防尘盖 PC端子防尘盖 电脑风扇防护 光纤晶体座

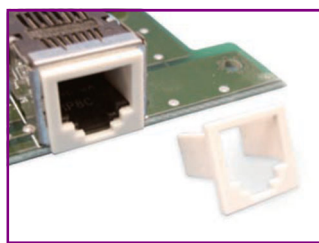
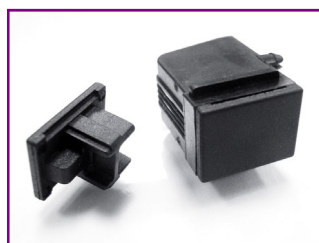
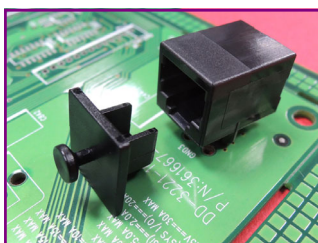
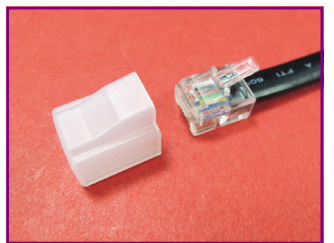
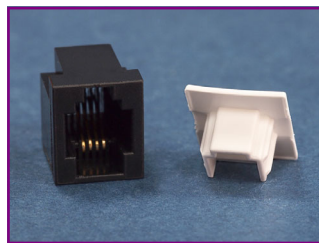
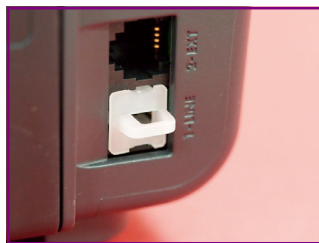
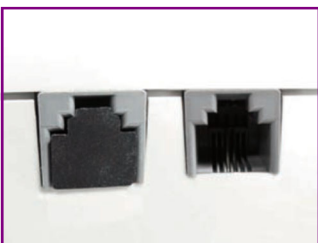
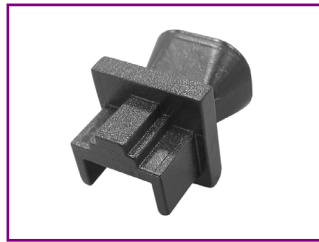
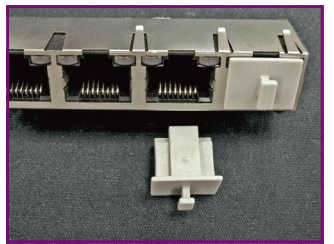
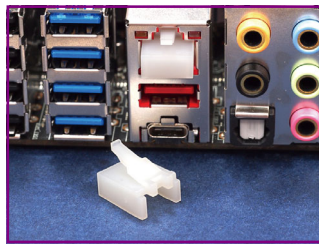
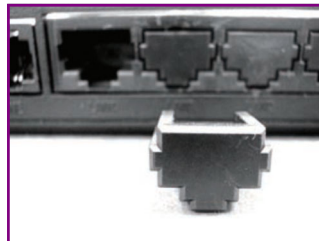
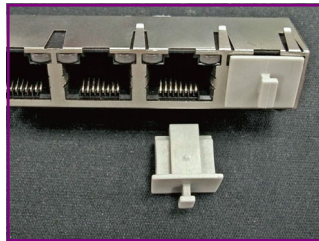
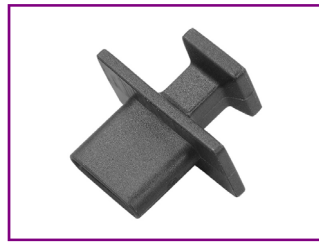
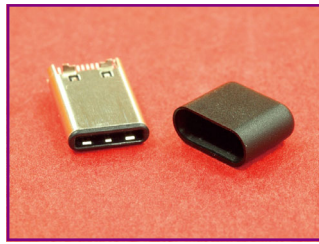
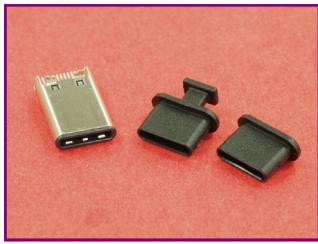

USB座护盖 电源插头防尘盖 RJ防尘盖 光纤保护盖 PC板金手指防尘盖 HDMI防尘盖 DVI防尘盖 KVM防尘盖 CF防尘盖 防尘盖 端子盖 S端子盖 平衡端子盖 BNC绝缘座 SATA防尘盖 ESATA护盖 DP端子防尘盖 1394端子防尘盖 D.Type防尘盖 VGA防尘盖 IDE Connector防尘盖 PC端子防尘盖 电脑风扇防护 光纤晶体座

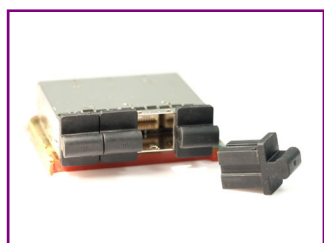
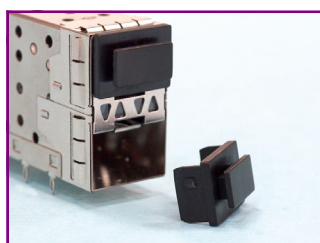
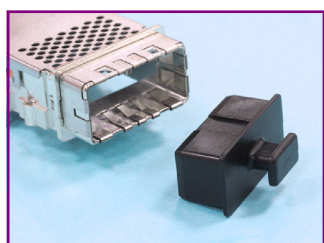
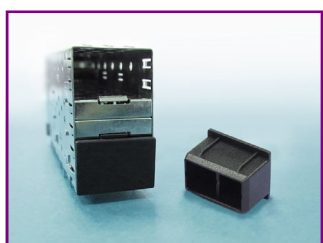
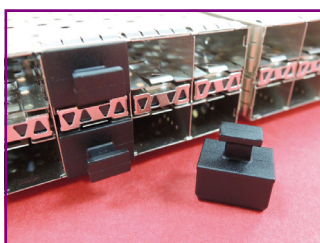
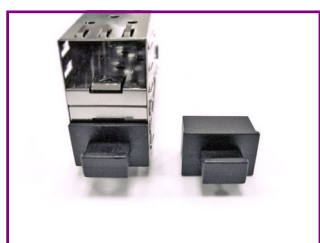
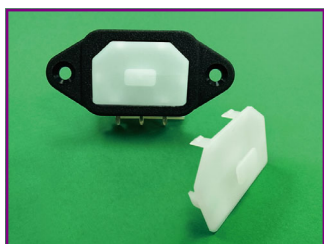

USB座护盖 电源插头防尘盖 RJ防尘盖 光纤保护盖 PC板金手指防尘盖 HDMI防尘盖 DVI防尘盖 KVM防尘盖 CF防尘盖 防尘盖 端子盖 S端子盖 平衡端子盖 BNC绝缘座 SATA防尘盖 ESATA护盖 DP端子防尘盖 1394端子防尘盖 D.Type防尘盖 VGA防尘盖 IDE Connector防尘盖 PC端子防尘盖 电脑风扇防护 光纤晶体座

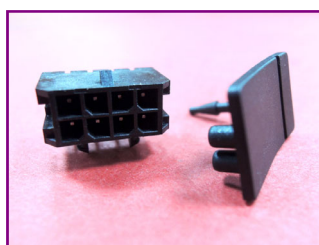
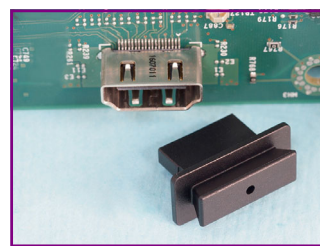
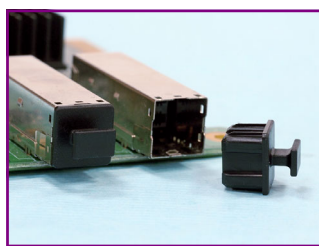
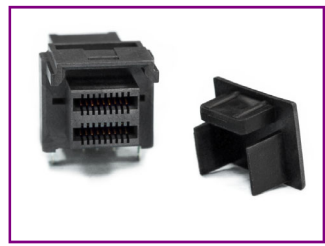
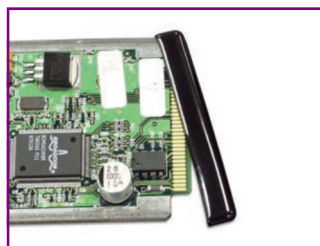
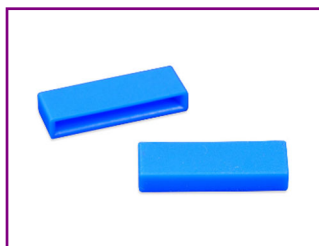
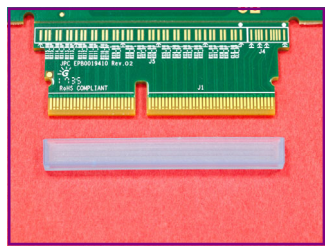
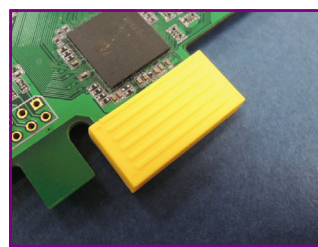
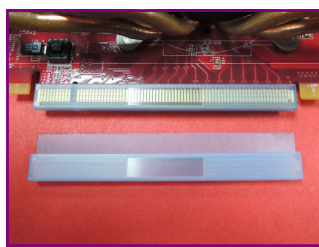
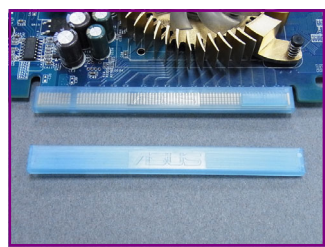
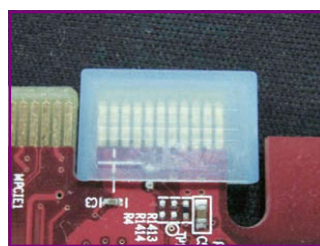
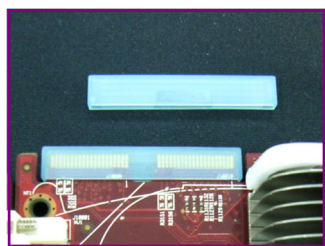

PC板金手指防尘盖

USB座护盖 电源插头防尘盖 RJ防尘盖 光纤保护盖 PC板金手指防尘盖 HDMI防尘盖 DVI防尘盖 KVM防尘盖 CF防尘盖 防尘盖 端子盖 S端子盖 平衡端子盖 BNC绝缘座 SATA防尘盖 ESATA护盖 DP端子防尘盖 1394端子防尘盖 D.Type防尘盖 VGA防尘盖 IDE Connector防尘盖 PC端子防尘盖 电脑风扇防护 光纤晶体座

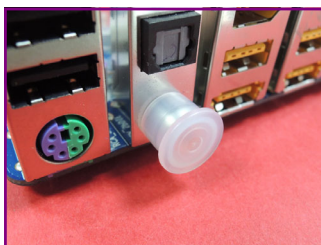
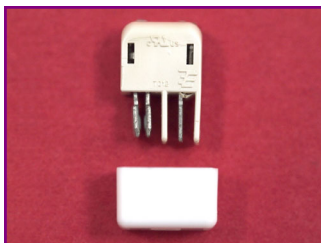
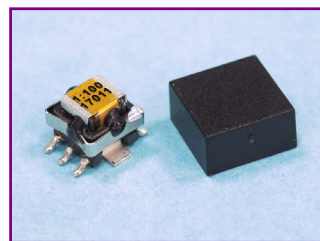
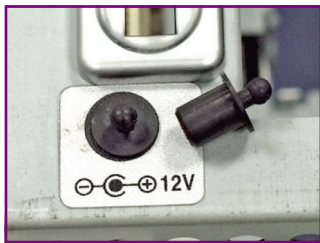
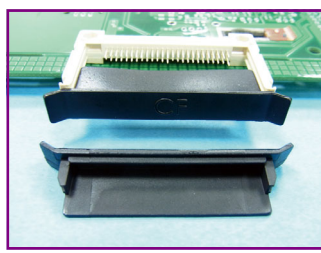

防尘盖

USB座护盖 电源插头防尘盖 RJ防尘盖 光纤保护盖 PC板金手指防尘盖 HDMI防尘盖 DVI防尘盖 KVM防尘盖 CF防尘盖 防尘盖 端子盖 S端子盖 平衡端子盖 BNC绝缘座 SATA防尘盖 ESATA护盖 DP端子防尘盖 1394端子防尘盖 D.Type防尘盖 VGA防尘盖 IDE Connector防尘盖 PC端子防尘盖 电脑风扇防护 光纤晶体座

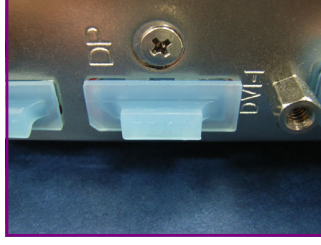
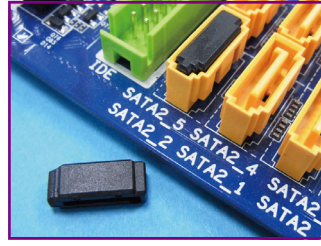
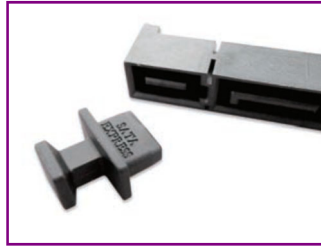
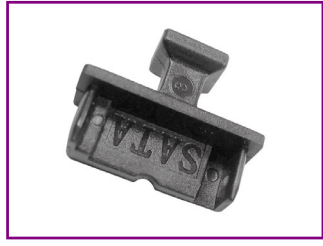
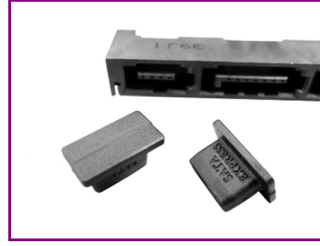
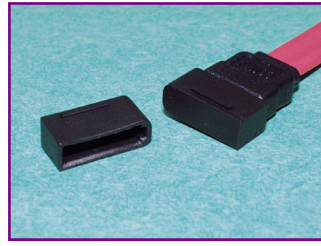
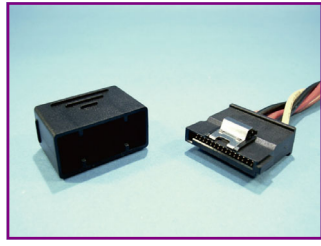
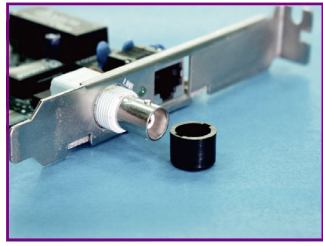
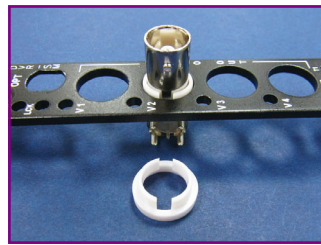
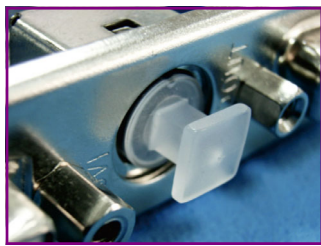
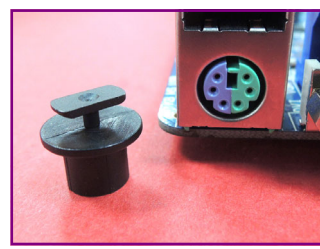
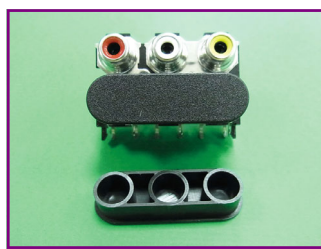

端子盖/防尘盖

USB座护盖 电源插头防尘盖 RJ防尘盖 光纤保护盖 PC板金手指防尘盖 HDMI防尘盖 DVI防尘盖 KVM防尘盖 CF防尘盖 防尘盖 端子盖 S端子盖 平衡端子盖 BNC绝缘座 SATA防尘盖 ESATA护盖 DP端子防尘盖 1394端子防尘盖 D.Type防尘盖 VGA防尘盖 IDE Connector防尘盖 PC端子防尘盖 电脑风扇防护 光纤晶体座

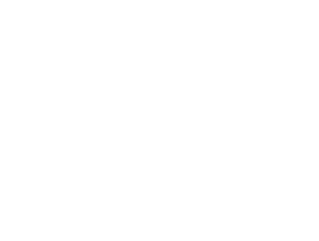
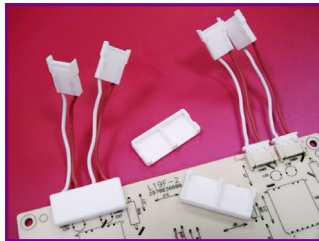
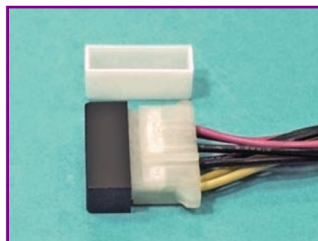
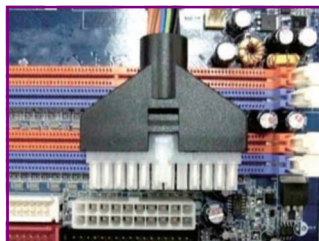
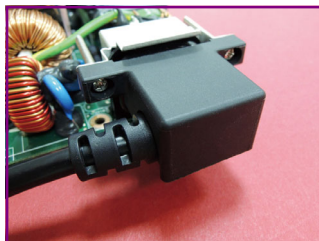
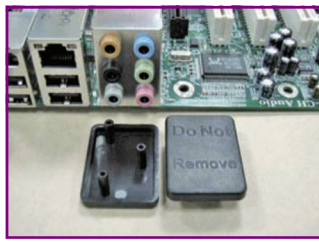
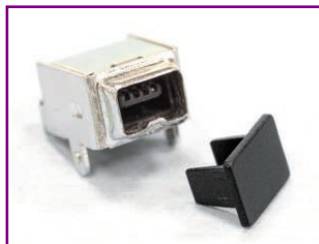
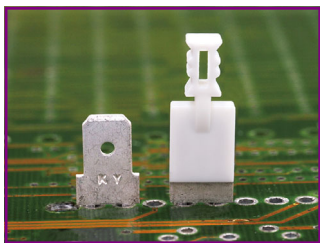
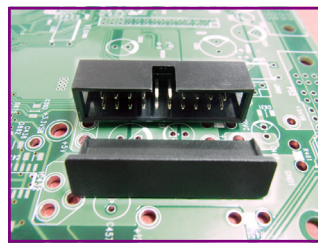
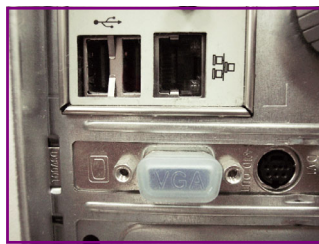
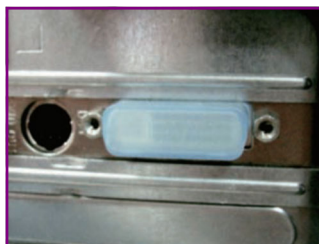
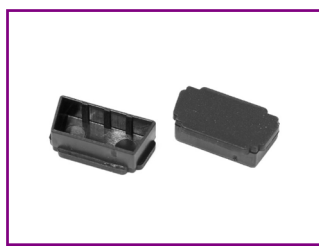
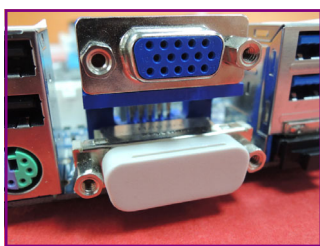

USB座护盖 电源插头防尘盖 RJ防尘盖 光纤保护盖 PC板金手指防尘盖 HDMI防尘盖 DVI防尘盖 KVM防尘盖 CF防尘盖 防尘盖 端子盖 S端子盖 平衡端子盖 BNC绝缘座 SATA防尘盖 ESATA护盖 DP端子防尘盖 1394端子防尘盖 D.Type防尘盖 VGA防尘盖 IDE Connector防尘盖 PC端子防尘盖 电脑风扇防护 光纤晶体座

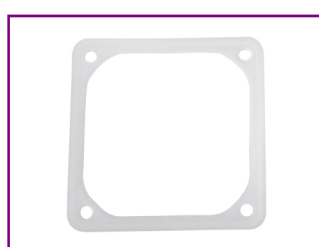
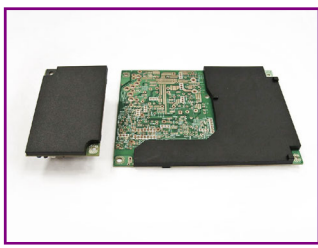
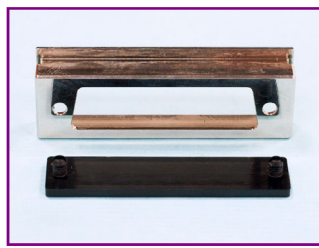
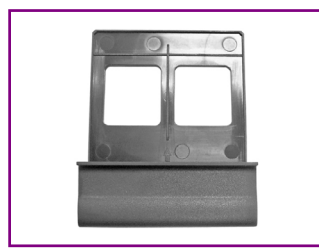

USB座护盖 USB PORT COVER USB端口保护盖 USB端口防尘盖



- ◆ MATERIAL : ABS (UL)
- ◆ FLAME CLASS : 94HB
- ◆ COLOR : BLACK
- ◆ UNIT: mm

用途： USB座护盖，用于USB接头防尘与保护。

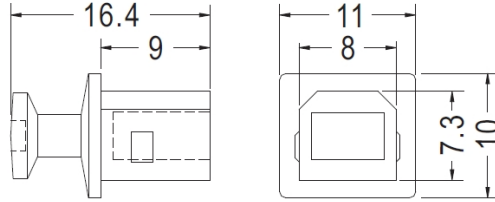

PART NO	PACKAGE
USB-C1	1000

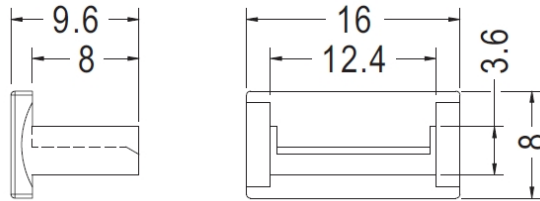
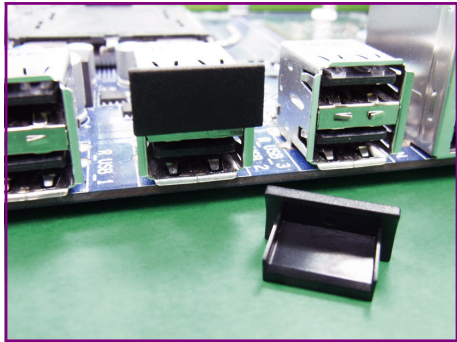

PART NO	PACKAGE
USB-C2	1000

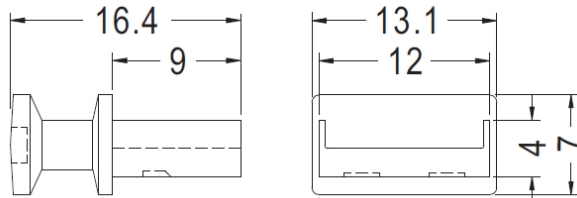

PART NO	PACKAGE
USB-C4	1000

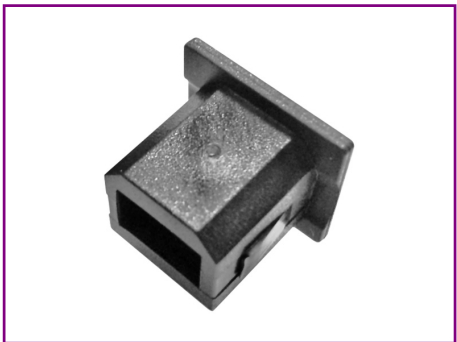

- ◆ MATERIAL : PP
- ◆ COLOR : BLACK/COMPUTER
- ◆ UNIT: mm

用途： USB座护盖，用于USB接头防尘与保护。

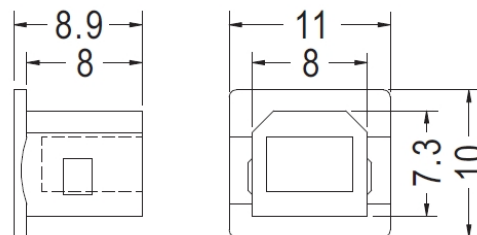

PART NO	PACKAGE
USB-C5	1000

USB座护盖 USB PORT COVER USB端口保护盖 USB端口防尘盖

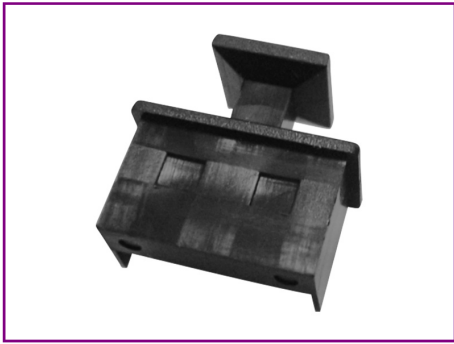

- ◆ MATERIAL : ABS (UL)
- ◆ FLAME CLASS : 94HB
- ◆ COLOR : BLACK
- ◆ UNIT: mm

用途: USB座护盖, 用于USB接头防尘与保护。

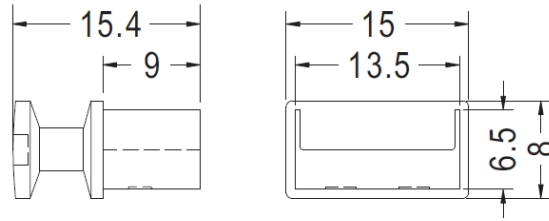

PART NO	PACKAGE
USB-C27	1000

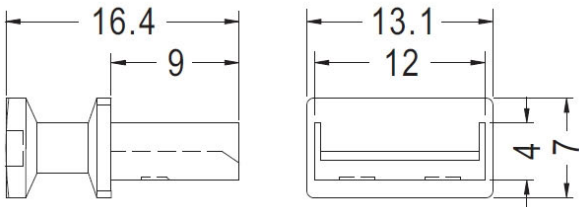

PART NO	PACKAGE
USB-C14	1000

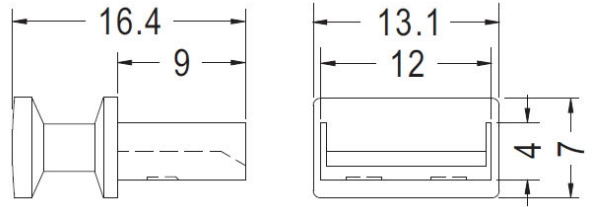

PART NO	PACKAGE
USB-C17	1000



- ◆ MATERIAL : PP
- ◆ COLOR : BLACK
- ◆ UNIT: mm

用途: USB座护盖, 用于USB接头防尘与保护。

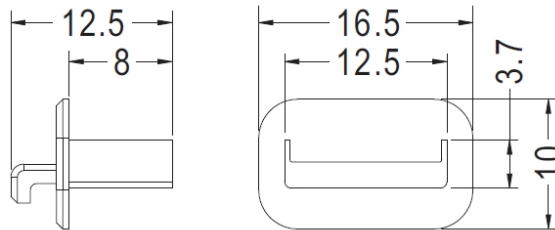

PART NO	PACKAGE
USB-C3	1000

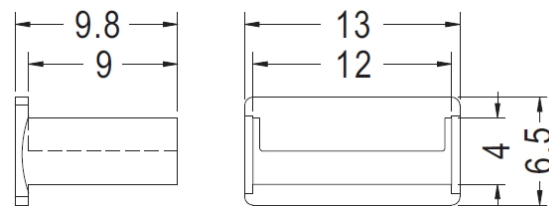

Color: Black/Computer

PART NO	PACKAGE
USB-C6	1000

USB座护盖 USB PORT COVER USB端口保护盖 USB端口防尘盖



- ◆ MATERIAL : PP (UL)
- ◆ FLAME CLASS : 94HB
- ◆ COLOR : BLACK/NATURAL
- ◆ UNIT: mm

用途： USB座护盖，用于USB接头防尘与保护。

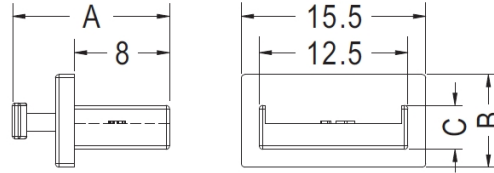

PART NO	A	B	C	PACKAGE
USB-C16	13.2	7.8	3.7	1000
USB-C28	14.5	8.0	3.8	1000



- ◆ MATERIAL : NYLON 66 (UL)
- ◆ FLAME CLASS : 94V-2/94V-0
- ◆ COLOR : BLACK
- ◆ UNIT: mm

用途： USB座护盖，用于USB接头防尘与保护。

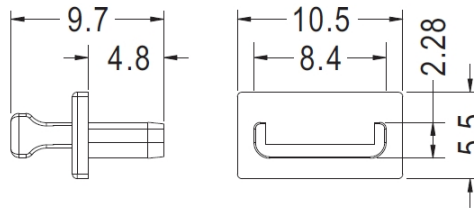

PART NO	PACKAGE
USB-C29	1000



- ◆ MATERIAL : TPE (UL)
- ◆ FLAME CLASS : 94V-0
- ◆ COLOR : BLACK
- ◆ UNIT: mm

用途： USB座护盖，用于USB接头防尘与保护。

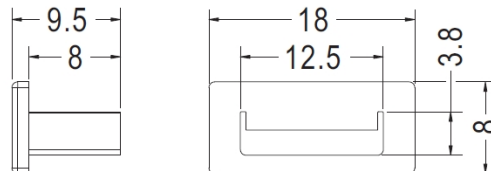

PART NO	PACKAGE
USB-C30	1000

USB座护盖 USB PORT COVER USB端口保护盖 USB端口防尘盖



- ◆ MATERIAL : TPE (UL)
- ◆ FLAME CLASS : 94V-0
- ◆ COLOR : BLACK
- ◆ UNIT: mm

用途: USB座护盖, 用于USB接头防尘与保护。

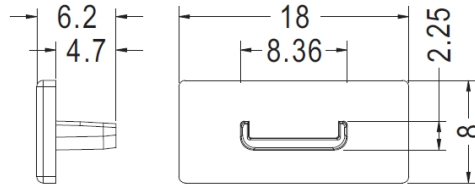

PART NO	PACKAGE
USB-C31	1000



- ◆ MATERIAL : PP
- ◆ COLOR : BLACK
- ◆ UNIT: mm

用途: USB座护盖, 用于USB接头防尘与保护。

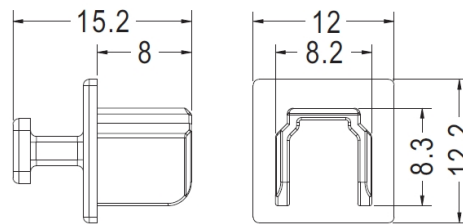

PART NO	PACKAGE
USB-C7	1000



- ◆ MATERIAL : NYLON 66 (UL)
- ◆ FLAME CLASS : 94V-0/94V-2
- ◆ COLOR : BLACK/NATURAL
- ◆ UNIT: mm

用途: USB座护盖, 用于重要的USB接头之堵塞, USB TYPE A DIP接头, 避免重要数据泄漏。拔取困难, 兼具防尘与保护。

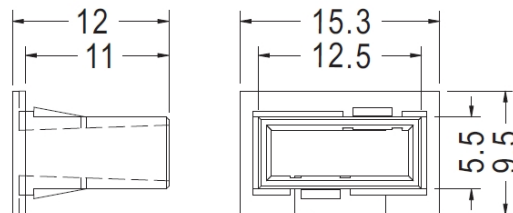

不可重複使用 Not Reusable

PART NO	PACKAGE
USB-C8	1000

USB座护盖 USB PORT COVER USB端口保护盖 USB端口防尘盖



- ◆ MATERIAL : NYLON 66 (UL)
- ◆ FLAME CLASS : 94V-2/94V-0
- ◆ COLOR : BLACK / NATURAL
- ◆ UNIT: mm

用途： USB座护盖，用于重要的USB接头之堵塞，避免重要数据泄漏。拔取困难，兼具防尘与保护。

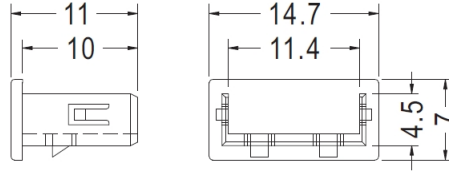

不可重複使用 Not Reusable

PART NO	PACKAGE
USB-C9	1000

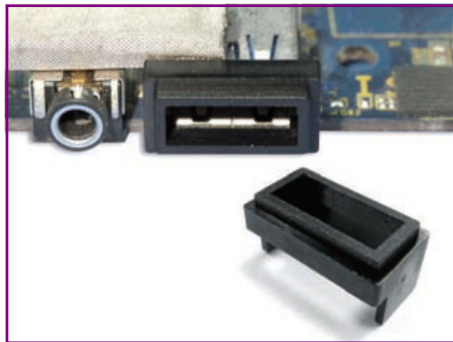

- ◆ MATERIAL : NYLON 66 (UL)
- ◆ FLAME CLASS : 94V-2/94V-0
- ◆ COLOR : BLACK/NATURAL
- ◆ UNIT: mm

用途： USB座护盖，用于USB接头防尘与保护。

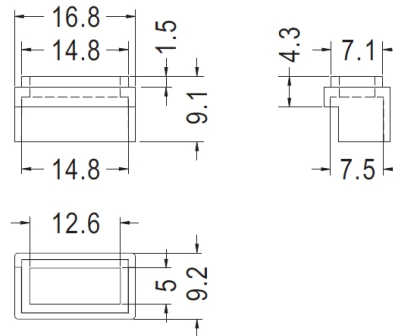

PART NO	PACKAGE
USB-C11	1000



- ◆ MATERIAL : TPE
- ◆ COLOR : BLACK
- ◆ UNIT: mm

用途： USB座护盖，用于USB接头防尘与保护。

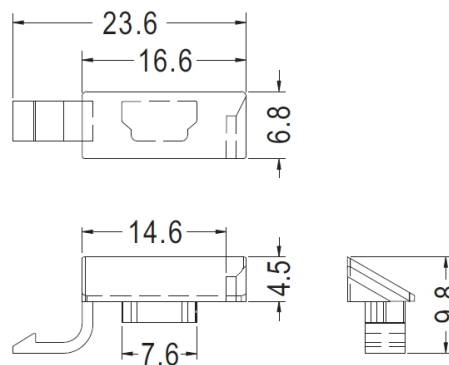

PART NO	PACKAGE
USB-C12	1000

USB座护盖 USB PORT COVER USB端口保护盖 USB端口防尘盖



- ◆ MATERIAL : TPE
- ◆ COLOR : BLACK
- ◆ UNIT: mm

用途: USB座护盖, 用于USB 3.0接头防尘与保护。

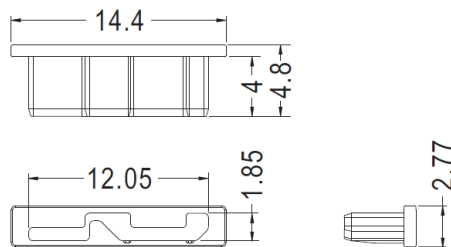

PART NO	PACKAGE
USB-C13	1000



- ◆ MATERIAL : TPU
- ◆ COLOR : BLACK
- ◆ UNIT: mm

用途: USB座护盖, 用于USB接头防尘与保护。

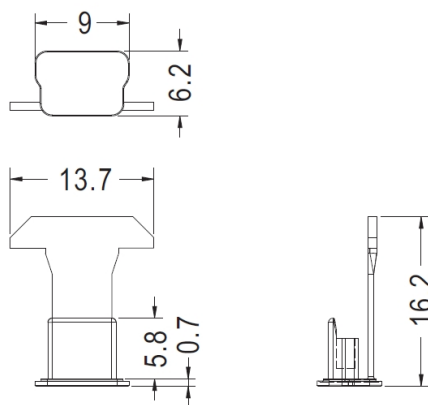

PART NO	PACKAGE
USB-C15	1000



- ◆ MATERIAL : NYLON 66 (UL)
- ◆ FLAME CLASS : 94V-0/94V-2
- ◆ COLOR : BLACK
- ◆ UNIT: mm

用途: USB座护盖, 用于POWER USB接头防尘与保护用。

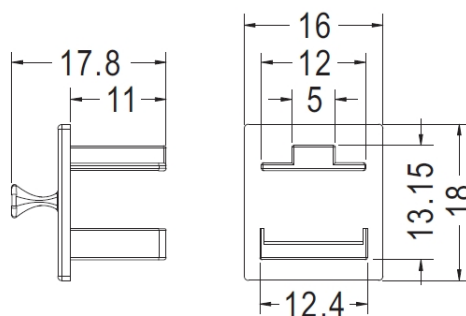

PART NO	PACKAGE
USB-C32	1000

USB座护盖 USB PORT COVER USB端口保护盖 USB端口防尘盖



- ◆ MATERIAL : TPE (UL)
- ◆ FLAME CLASS : 94V-0
- ◆ COLOR : BLACK
- ◆ UNIT: mm

用途： USB座护盖，用于POWER
USB接头防尘与保护用。

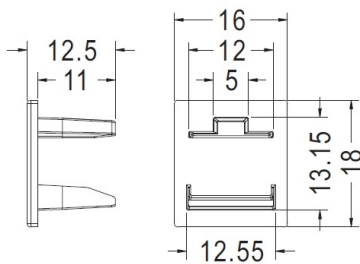

PART NO	PACKAGE
USB-C33	1000

Micro USB防尘盖 Micro USB Port Cover USB端口保护盖 USB端口防尘盖

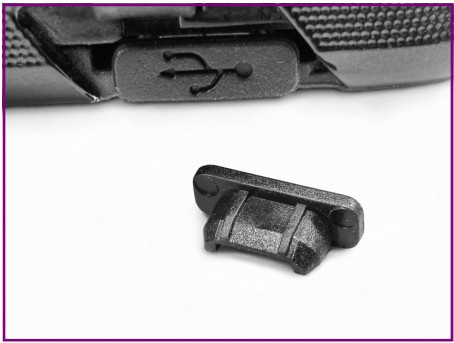

- ◆ MATERIAL : TPE
- ◆ COLOR : BLACK
- ◆ UNIT: mm

用途： Micro USB防尘盖，用于 Micro USB接头防尘与保护用。

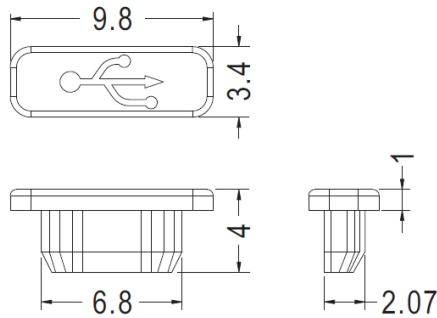

PART NO	PACKAGE
USB-C21	1000



- ◆ MATERIAL : PE
- ◆ COLOR : BLACK
- ◆ UNIT: mm

用途： USB座护盖，用于Micro USB接头防尘与保护用。

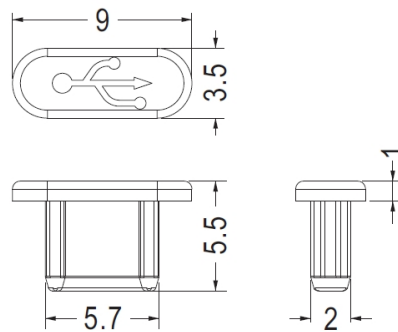

PART NO	PACKAGE
USB-C25	1000



- ◆ MATERIAL : TPE (UL)
- ◆ FLAME CLASS : 94V-0
- ◆ COLOR : BLACK
- ◆ UNIT: mm

用途： USB座护盖，用于Micro USB接头防尘与保护用。

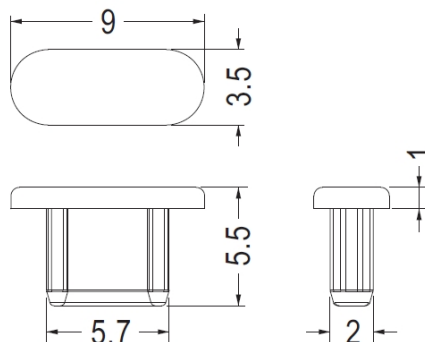

PART NO	PACKAGE
USB-C25	1000

Micro USB防尘盖 Micro USB Port Cover USB端口保护盖 USB端口防尘盖



- ◆ MATERIAL : PE (UL)
- ◆ COLOR : NATURAL
- ◆ UNIT: mm

用途： Micro USB防尘盖，用于 Micro USB接头防尘与保护用。

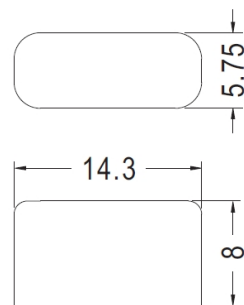
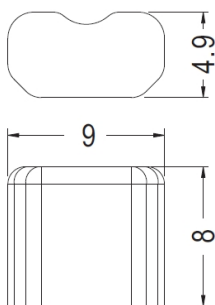

PART NO	PACKAGE
USB-C24	2000

PART NO	PACKAGE
USB-C26	1000

Mini USB座护盖 Micro USB Port Cover USB端口保护盖 USB端口防尘盖



- ◆ MATERIAL : PP (UL)
- ◆ FLAME CLASS : 94HB
- ◆ COLOR : BLACK
- ◆ UNIT: mm

用途： Mini USB座护盖，用于Mini USB接头防尘与保护用。

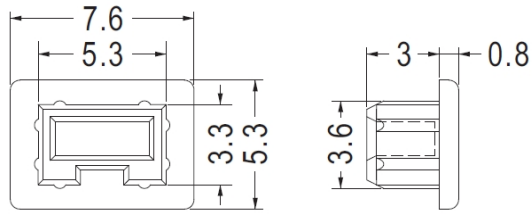

PART NO	PACKAGE
USB-C10	1000



- ◆ MATERIAL : TPE
- ◆ COLOR : BLACK
- ◆ UNIT: mm

用途： Mini USB座护盖，用于Mini USB接头防尘与保护用。

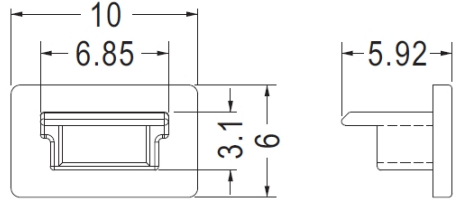
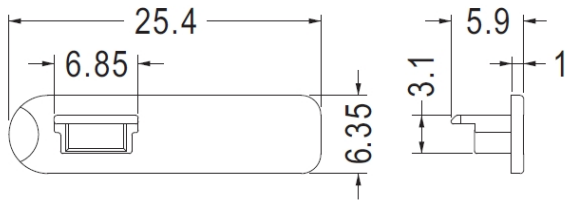

PART NO	PACKAGE
USB-C19	1000

PART NO	PACKAGE
USB-C18	1000

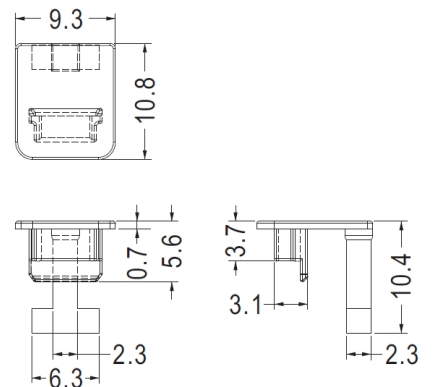
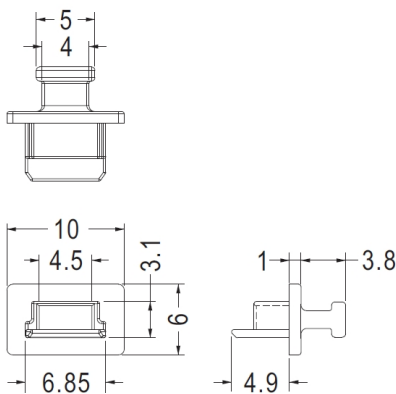

PART NO	PACKAGE
USB-C22	1000

PART NO	PACKAGE
USB-C20	1000

Mini USB防尘盖 Mini USB Plug Cover



- ◆ MATERIAL : PE
- ◆ COLOR : NATURAL
- ◆ UNIT: mm

用途： Mini USB防尘盖，用于Mini USB接头之防尘与保护。

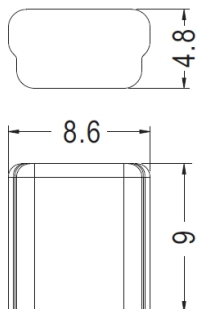

PART NO	PACKAGE
USB-C34	2000

USB Type-C防尘盖 USB 3.0 Type-C Cover USB护盖

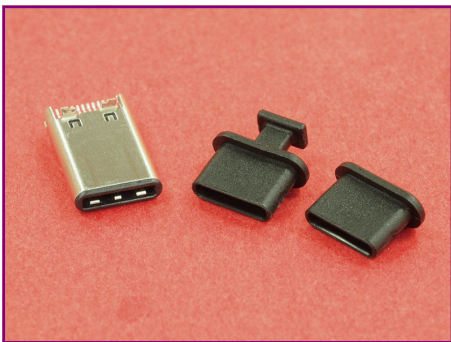

- ◆ MATERIAL : PE
- ◆ COLOR : BLACK
- ◆ UNIT: mm

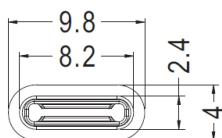
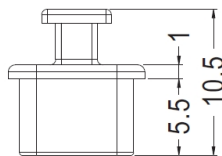

PART NO	PACKAGE
USB-TYPR-C-1	1000

用途： USB Type-C防尘盖，用于 USB 3.0 TYPE-C接头之防尘与保护。

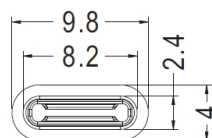
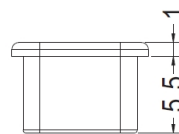

PART NO	PACKAGE
USB-TYPR-C-2	1000

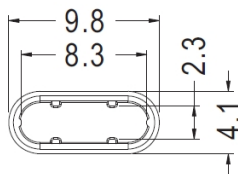
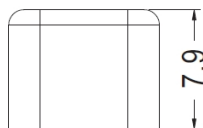
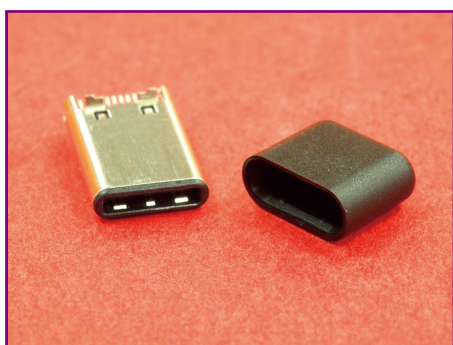

PART NO	PACKAGE
USB-TYPR-C-3	1000

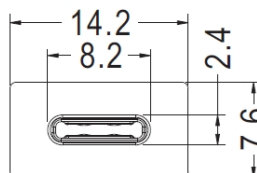
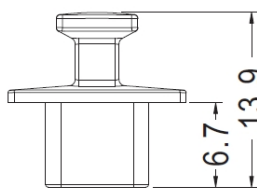

PART NO	PACKAGE
USB-TYPR-C-4	1000

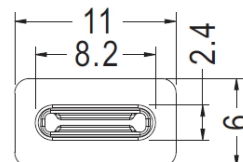
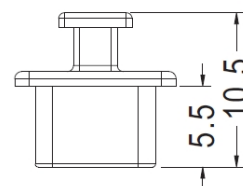

PART NO	PACKAGE
USB-TYPR-C-5	1000

USB防尘盖 USB Connector Cover



- ◆ MATERIAL : TPE
- ◆ COLOR : BLACK
- ◆ UNIT: mm

用途: USB防尘盖, 用于USB接头防尘与保护用。

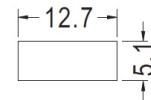
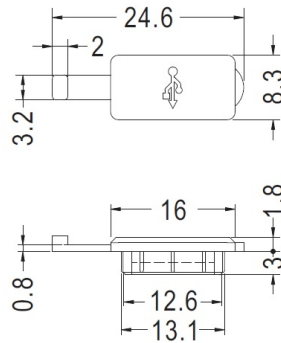

MOUNTING HOLE

PART NO	PACKAGE
GFR-30	500



- ◆ MATERIAL : SILICON RUBBER(UL)
- ◆ FLAME CLASS : 94V-0
- ◆ COLOR : BLACK
- ◆ UNIT: mm

用途: USB防尘盖, 用于USB接头防尘与保护用。

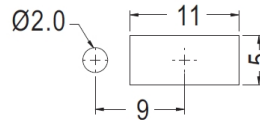
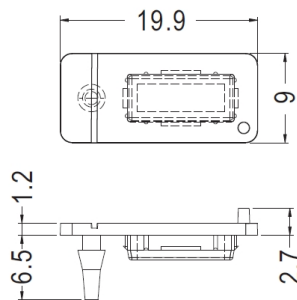

MOUNTING HOLE THICKNESS 1.0

PART NO	PACKAGE
GFR-61	1000



- ◆ MATERIAL : SILICON RUBBER
- ◆ COLOR : BLACK
- ◆ UNIT: mm

用途: USB防尘盖, 用于USB接头防尘与保护用。

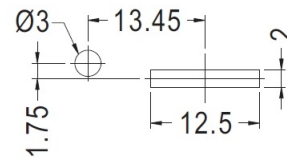
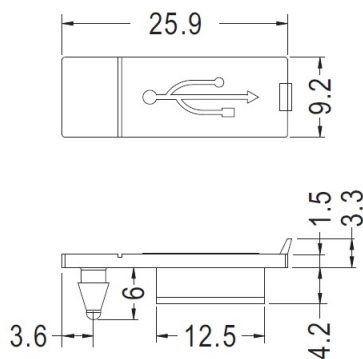

MOUNTING HOLE THICKNESS 1.5

PART NO	PACKAGE
GFR-11	1000

USB防尘盖 USB Connector Cover



- ◆ MATERIAL : TPU
- ◆ COLOR : BLACK/WHITE
- ◆ UNIT: mm

用途： USB防尘盖，用于USB接头防尘与保护用。

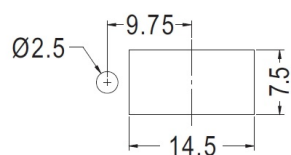
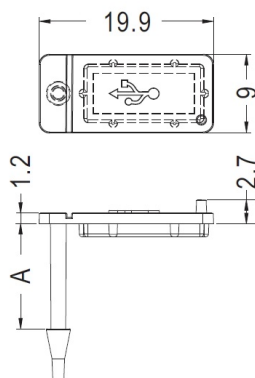

MOUNTING HOLE

PART NO	A	PACKAGE
GFR-28	1.8	500
GFR-29	12.0	500

RJ-45防尘盖 RJ45 Port Cover



- ◆ MATERIAL : ABS(UL)
- ◆ FLAME CLASS : 94HB
- ◆ COLOR : BLACK
- ◆ UNIT: mm

用途： RJ-45防尘盖，用于网络接头
RJ-45防尘与保护。

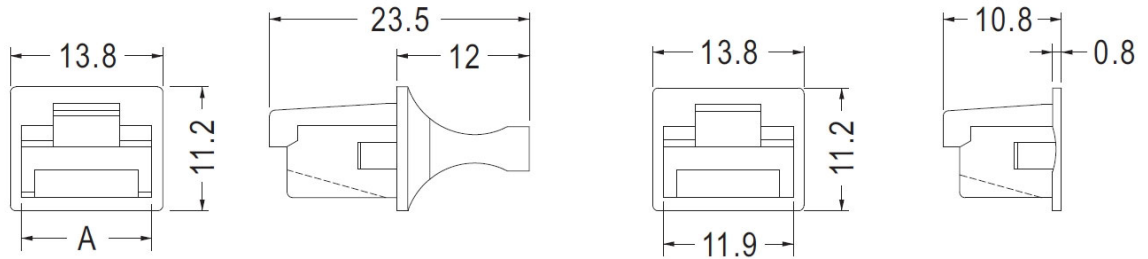

PART NO	A	PACKAGE
RJ45-C01	11.9	500
RJ45-C06	12.0	500

PART NO	PACKAGE
RJ45-C03	500

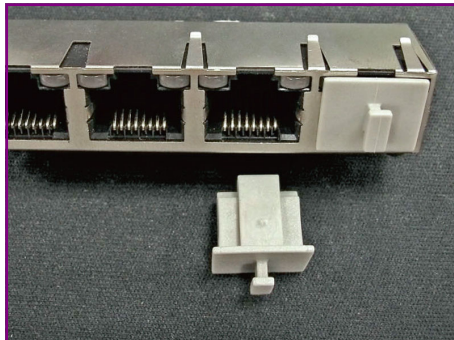

- ◆ MATERIAL : PE
- ◆ COLOR : BLACK / GRAY
- ◆ UNIT: mm

用途： RJ-45防尘盖，用于网络接头
RJ-45防尘与保护。

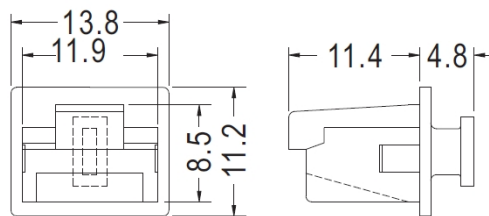

PART NO	PACKAGE
RJ45-C02	500

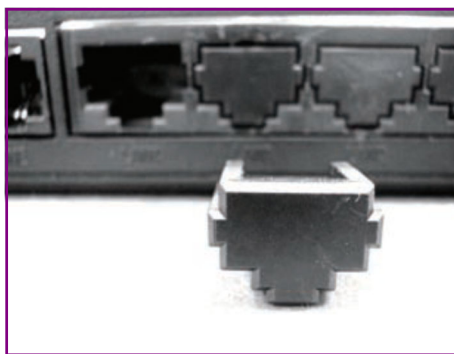

- ◆ MATERIAL : PE
- ◆ COLOR : BLACK
- ◆ UNIT: mm

用途： RJ-45防尘盖，用于多余的RJ
-45连接器之堵塞，避免误用。

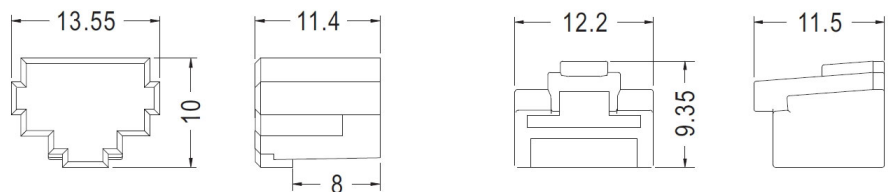

PART NO	PACKAGE
RJ45-C04	500

PART NO	PACKAGE
RJ45-C05	500

RJ-45防尘盖 RJ45 Port Cover



- ◆ MATERIAL : NYLON 66(UL)
- ◆ FLAME CLASS : 94V-2/94V-0
- ◆ COLOR : BLACK
- ◆ UNIT: mm

用途: RJ-45防尘盖, 用于网络接头
RJ-45防尘与保护。

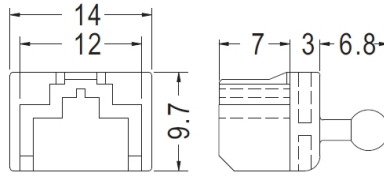

PART NO	PACKAGE
RJ45-C07	1000

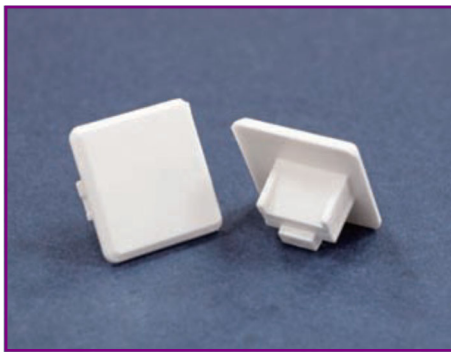

- ◆ MATERIAL : ABS
- ◆ COLOR : WHITE
- ◆ UNIT: mm

用途: RJ-45防尘盖, 用于网络接头
RJ-45防尘与保护。

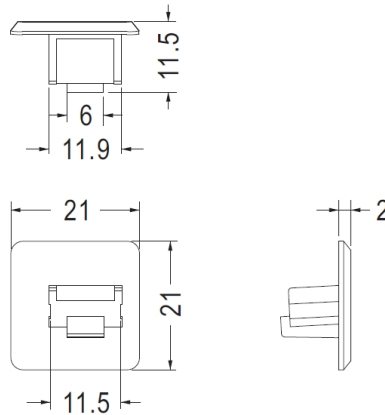

PART NO	PACKAGE
RJ45-C08	1000

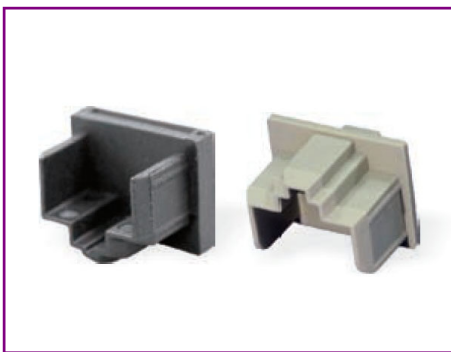

用途: RJ-45防尘盖, 用于网络接头RJ-45防尘与保护。

- ◆ MATERIAL : NYLON 66(UL)
- ◆ FLAME CLASS : 94V-2/94V-0
- ◆ COLOR : BLACK/NATURAL
- ◆ UNIT: mm

- ◆ MATERIAL : PE
- ◆ COLOR : GRAY
- ◆ UNIT: mm

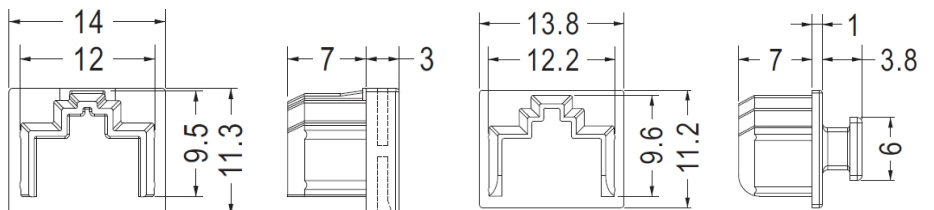

PART NO	PACKAGE
RJ45-C09	1000

PART NO	PACKAGE
RJ45-C11	1000

RJ-45防尘盖 RJ45 Port Cover

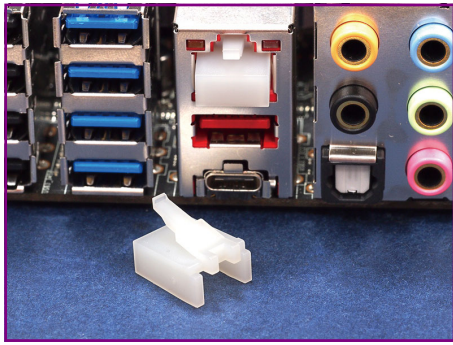

- ◆ MATERIAL : NYLON 66(UL)
- ◆ FLAME CLASS : 94V-2/94V-0
- ◆ COLOR : BLACK/NATURAL
- ◆ UNIT: mm

用途: RJ-45防尘盖, 用于网络接头
RJ-45防尘与保护。

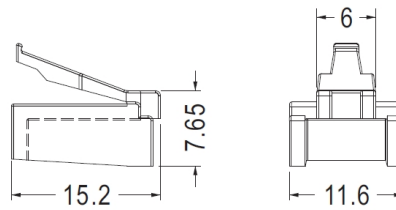

PART NO	PACKAGE
RJ45-C10	500

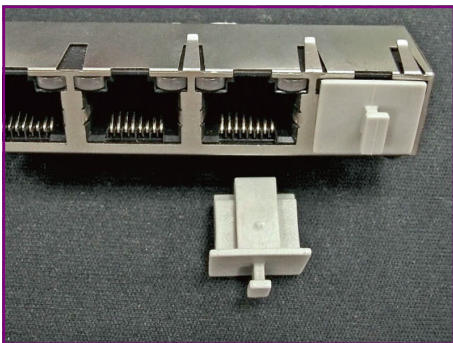

用途: RJ-45防尘盖, 用于网络接头RJ-45防尘与保护。

- ◆ MATERIAL : PE
- ◆ COLOR : BLACK
- ◆ UNIT: mm

- ◆ MATERIAL : NYLON 66(UL)
- ◆ FLAME CLASS : 94V-2/94V-0
- ◆ COLOR : BLACK
- ◆ UNIT: mm

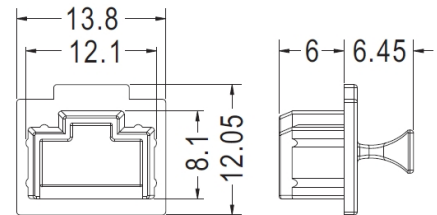
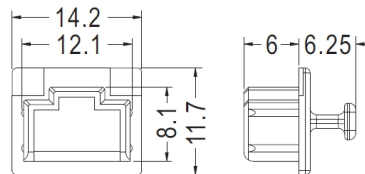

PART NO	PACKAGE
RJ45-C12	1000

PART NO	PACKAGE
RJ45-C13	1000



- ◆ MATERIAL : NYLON 66(UL)
- ◆ FLAME CLASS : 94V-2/94V-0
- ◆ COLOR : BLACK
- ◆ UNIT: mm

- ◆ MATERIAL : NYLON 66(UL)
- ◆ FLAME CLASS : 94V-2/94V-0
- ◆ COLOR : BLACK/GRAY
- ◆ UNIT: mm

- ◆ MATERIAL : TPE(UL)
- ◆ FLAME CLASS : 94V-0
- ◆ COLOR : GRAY
- ◆ UNIT: mm

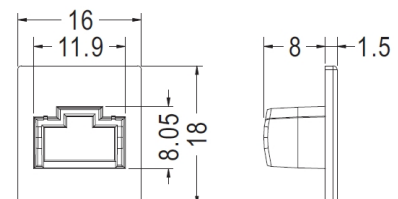
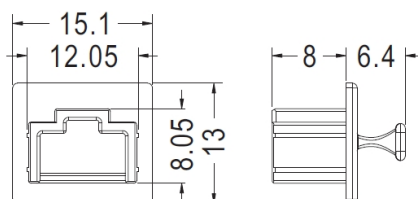
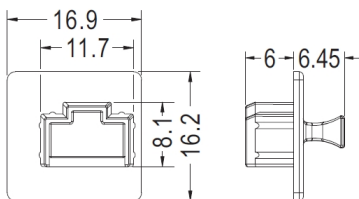

PART NO	PACKAGE
RJ45-C14	1000

PART NO	PACKAGE
RJ45-C15	1000

PART NO	PACKAGE
RJ45-C16	1000

RJ-45防尘盖 RJ45 Port Cover



- ◆ MATERIAL : PE
- ◆ COLOR : NATURAL
- ◆ UNIT: mm

用途: RJ-45防尘盖, 用于网络接头
RJ-45防尘与保护。

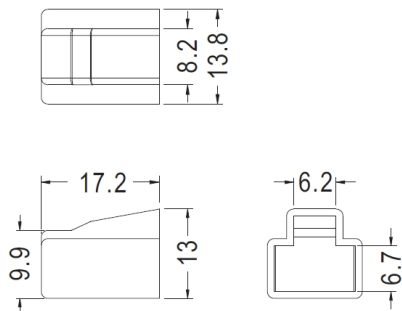

PART NO	PACKAGE
RJ45-C17	1000



- ◆ MATERIAL : PE
- ◆ COLOR : BLACK
- ◆ UNIT: mm

用途: RJ-45防尘盖, 用于网络接头
RJ-45防尘与保护。

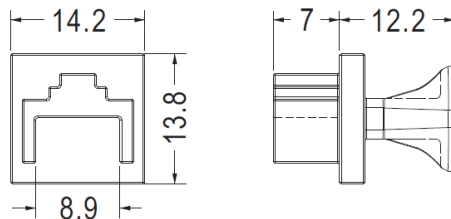

PART NO	PACKAGE
RJ45-C18	500

RJ-11防尘盖 RJ11 Plug Cover

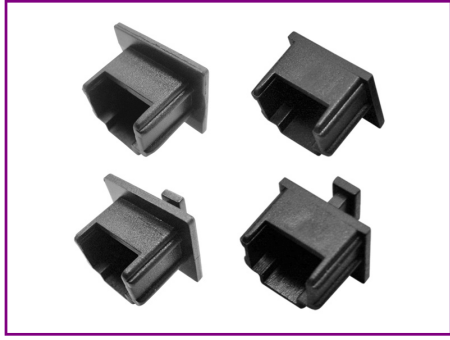

- ◆ MATERIAL : PE
- ◆ COLOR : BLACK
- ◆ UNIT: mm

用途: RJ-11防尘盖, 用于RJ-11连接器之防尘与保护。

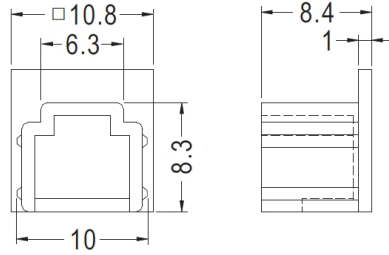

PART NO	PACKAGE
RJ-11-1	1000

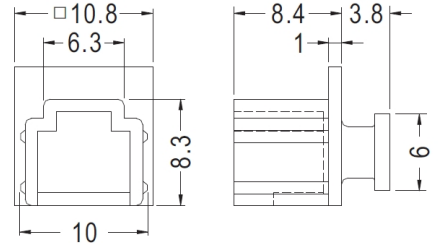

PART NO	PACKAGE
RJ-11-5	1000

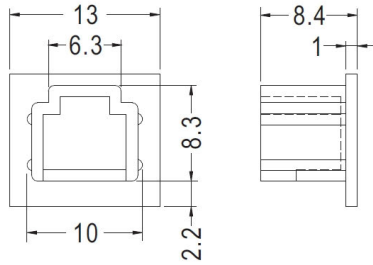

PART NO	PACKAGE
RJ-11-2	1000

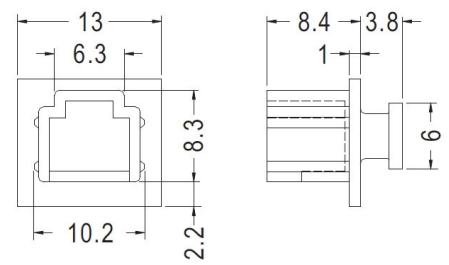

PART NO	PACKAGE
RJ-11-4	1000

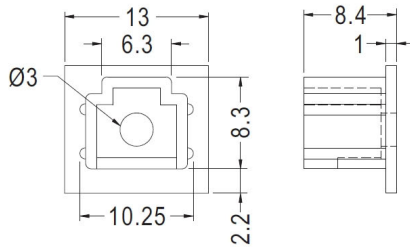

PART NO	PACKAGE
RJ-11-3	1000

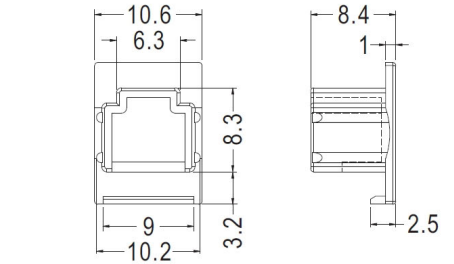

PART NO	PACKAGE
RJ-11-10	1000

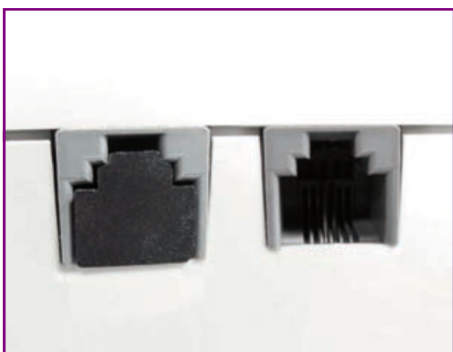

- ◆ MATERIAL : SILICON RUBBER
- ◆ COLOR : BLACK
- ◆ UNIT: mm

用途: RJ-11防尘盖, 用于多余的RJ-11连接器之防尘, 避免误用。

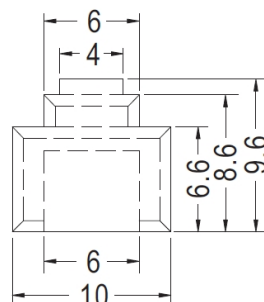

PART NO	PACKAGE
RJ-11-6	1000

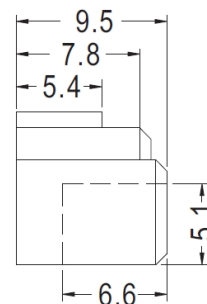

RJ-11防尘盖 RJ11 Plug Cover

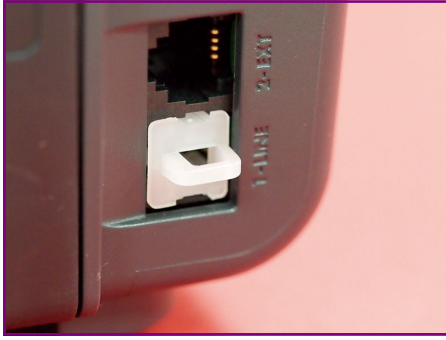

- ◆ MATERIAL : NYLON 66(UL)
- ◆ FLAME CLASS : 94V-2/94V-0
- ◆ COLOR : BLACK/NATURAL
- ◆ UNIT: mm

用途: RJ-11防尘盖, 用于RJ-11连接器之防尘与保护。

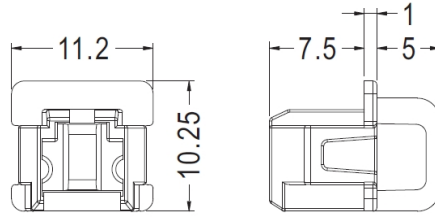

PART NO	PACKAGE
RJ-11-7	1000

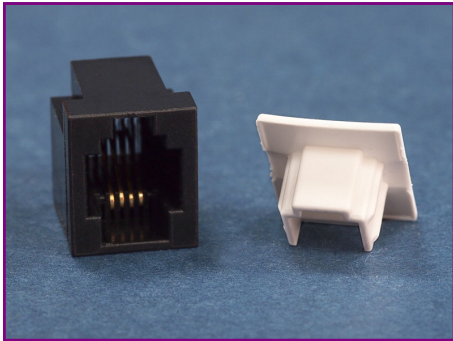

- ◆ MATERIAL : PE
- ◆ COLOR : WHITE
- ◆ UNIT: mm

用途: RJ-11防尘盖, 用于RJ-11连接器之防尘盖。

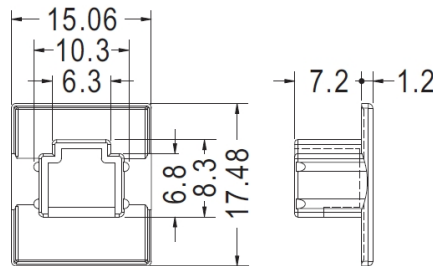

PART NO	PACKAGE
RJ-11-9	1000

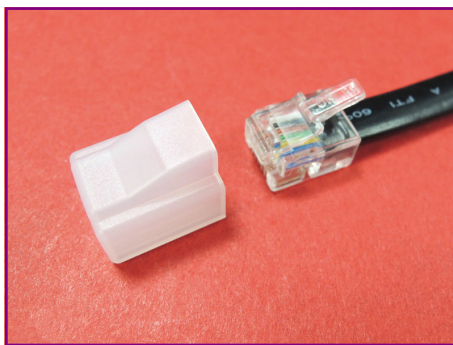

- ◆ MATERIAL : PE
- ◆ COLOR : NATURAL
- ◆ UNIT: mm

用途: RJ-11防尘盖, 用于RJ-11连接器之防尘盖。

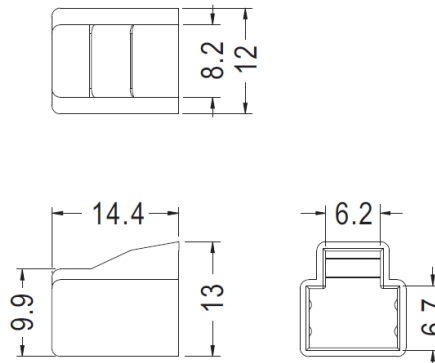

PART NO	PACKAGE
RJ-11-11	1000

RJ-12防尘盖 RJ12 Port Cover

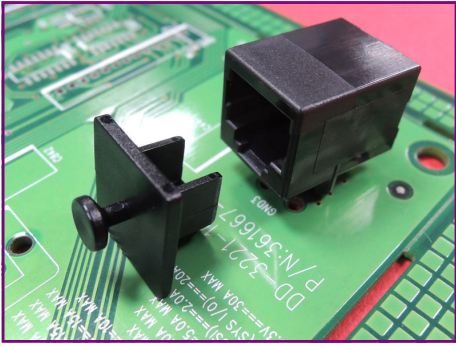

用途： RJ-12防尘盖，用于网络接头RJ-12防尘与保护。

- ◆ MATERIAL : NYLON 66(UL)
- ◆ FLAME CLASS : 94V-2/94V-0
- ◆ COLOR : BLACK/NATURAL
- ◆ UNIT: mm

- ◆ MATERIAL : NYLON 66(UL)
- ◆ FLAME CLASS : 94V-2/94V-0
- ◆ COLOR : BLACK/GRAY
- ◆ UNIT: mm

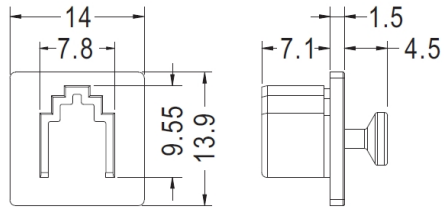

PART NO	PACKAGE
RJ-12-1	1000

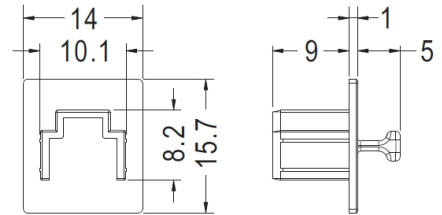

PART NO	PACKAGE
RJ-12-2	1000

RJ-22防尘盖 RJ22 Port Cover

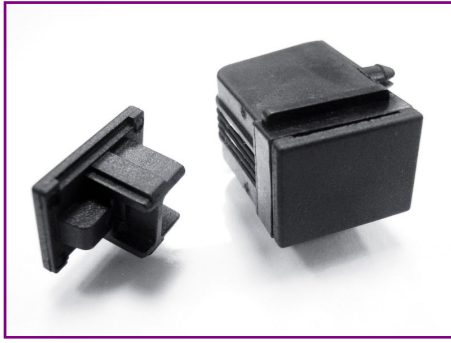

- ◆ MATERIAL : PE
- ◆ COLOR : BLACK
- ◆ UNIT: mm

用途: RJ-22防尘盖, 用于网络接头
RJ-22防尘与保护。

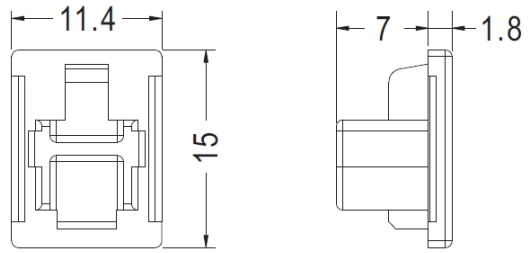

PART NO	PACKAGE
RJ-22	1000

RJ防尘盖 Connector Cover RJ端子盖

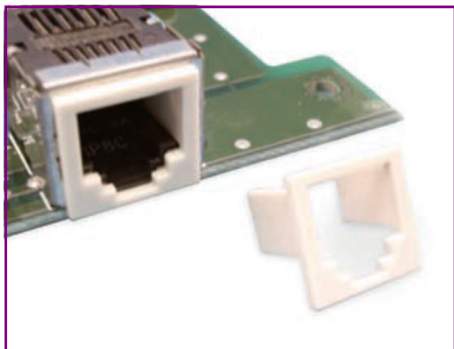

- ◆ MATERIAL : ABS(UL)
- ◆ FLAME CLASS : 94HB
- ◆ COLOR : WHITE/NATURAL
- ◆ UNIT: mm

用途： 端子盖，用于RJ-45转接RJ-11接头。

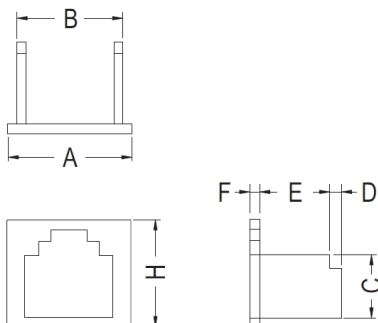

PART NO	A	B	C	D	E	F	H	PACKAGE
DZGR-03	13.5	12.0	6.8	-	8.0	1.1	12.9	1000
DZGR-04	13.9	11.9	7.1	1.3	7.9	1.1	12.0	1000
DZGR-13	11.8	9.6	7.0	1.5	8.0	1.0	12.5	1000

电源插头防尘盖 Power Connector Cover



- ◆ MATERIAL : PE
- ◆ COLOR : NATURAL
- ◆ UNIT: mm

用途：电源插头防尘盖，保护电源插头的防尘、防氧化。

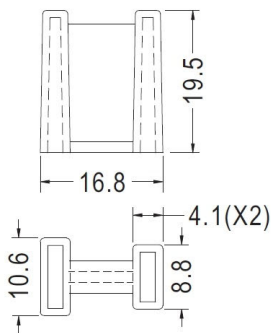

PART NO	PACKAGE
LPCG-1	250

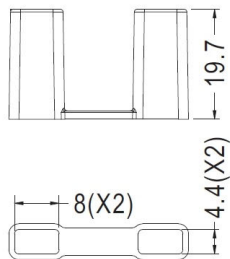

PART NO	PACKAGE
LPCG-3	1000

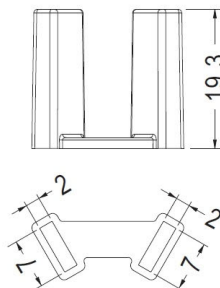

PART NO	PACKAGE
LPCG-4	1000

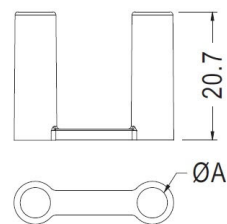

PART NO	PACKAGE
LPCG-5	4.9 1000
LPCG-6	4.1 1000

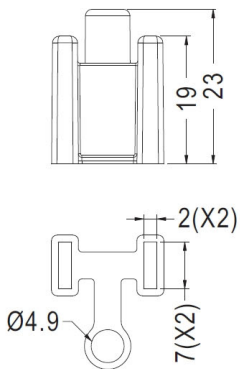

PART NO	PACKAGE
LPCG-7	1000

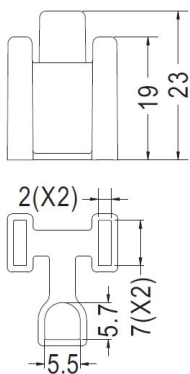

PART NO	PACKAGE
LPCG-9	1000

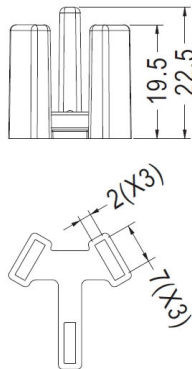

PART NO	PACKAGE
LPCG-8	1000

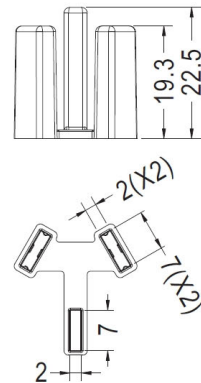

PART NO	PACKAGE
LPCG-10	1000

电源插头防尘盖



- ◆ MATERIAL : PP
- ◆ COLOR : NATURAL
- ◆ UNIT: mm

用途：电源插头防尘盖，保护电源插头的防尘、防氧化。

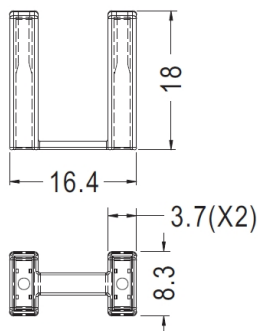

PART NO	PACKAGE
LPCG-2	250

电源插头保护座 Socket Cover



- ◆ MATERIAL : NYLON 66(UL)
- ◆ FLAME CLASS : 94V-2/94V-0
- ◆ COLOR : BLACK
- ◆ UNIT: mm

用途：电源插头保护座，用于电源插座后端，防短路、保护。

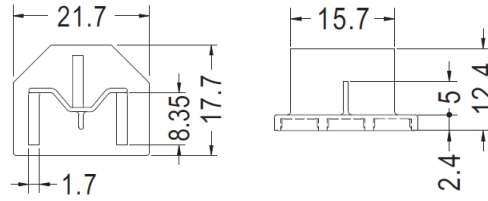

PART NO	PACKAGE
SCK-1	500

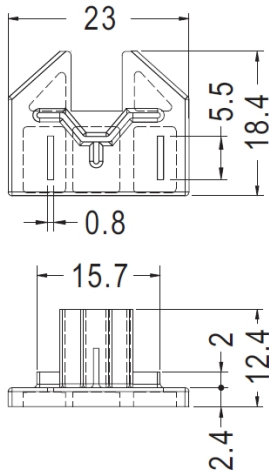
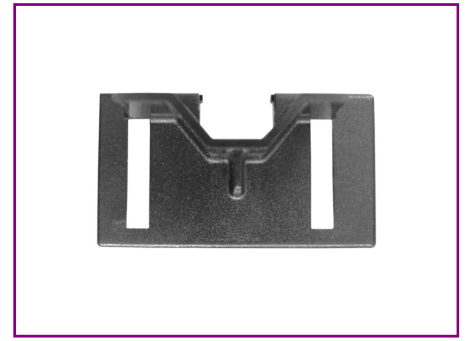
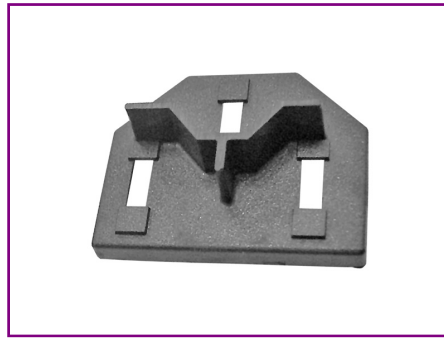

PART NO	PACKAGE
SCK-2	500

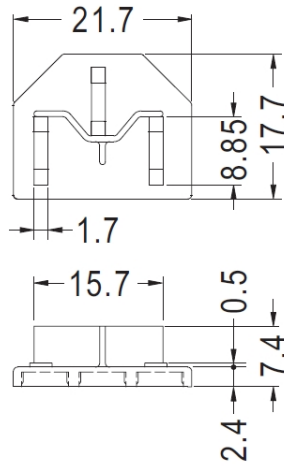

PART NO	PACKAGE
SCK-3	500

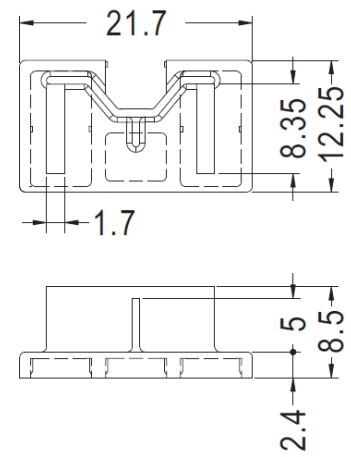

PART NO	PACKAGE
SCK-4	500

电源插座防尘盖 Power Connector Cover

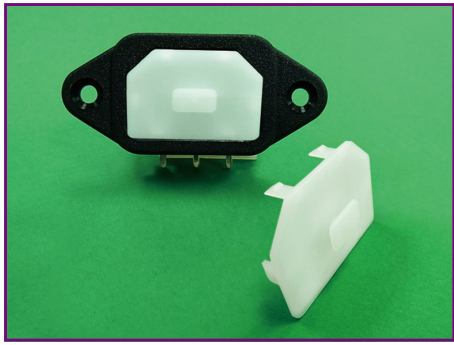

- ◆ MATERIAL : NYLON 66(UL)
- ◆ FLAME CLASS : 94V-2/94V-0
- ◆ COLOR : BLACK/NATURAL
- ◆ UNIT: mm

用途：电源插座防尘盖，用于电源座的防尘与保护。

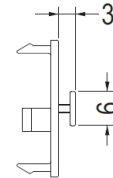
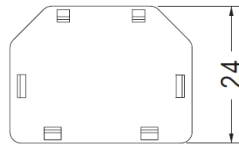
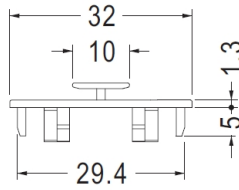

PART NO	PACKAGE
KLCB01	500

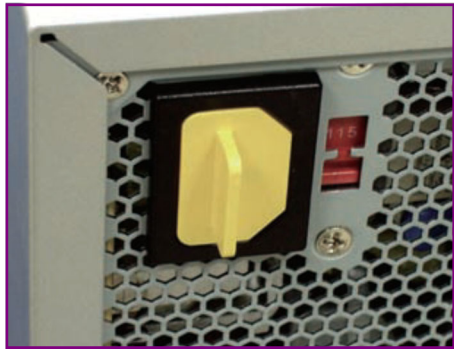

- ◆ MATERIAL : PE
- ◆ COLOR : BLACK/YELLOW
- ◆ UNIT: mm

用途：电源插座防尘盖，用于电源座的防尘与保护。

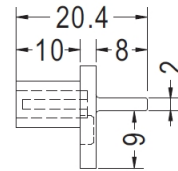
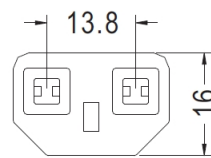
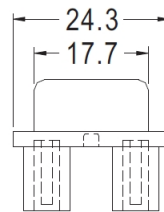

PART NO	PACKAGE
KLCB02	250



- ◆ MATERIAL : TPE(UL)
- ◆ FLAME CLASS : 94V-0
- ◆ COLOR : BLACK
- ◆ UNIT: mm

用途：电源插座防尘盖，用于电源座的防尘与保护。

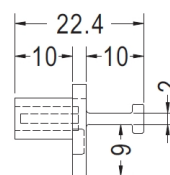
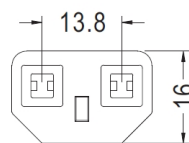
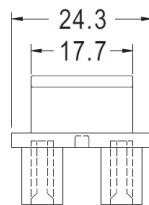

PART NO	PACKAGE
KLCB06	250

电源插座防尘盖 Power Connector Cover



- ◆ MATERIAL : NYLON 66(UL)
- ◆ FLAME CLASS : 94V-2/94V-0
- ◆ COLOR : BLACK
- ◆ UNIT: mm

用途：电源插座防尘盖，用于电源插座接头防尘与保护。

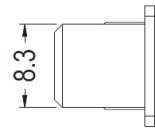
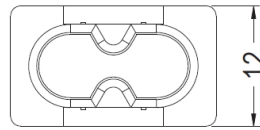
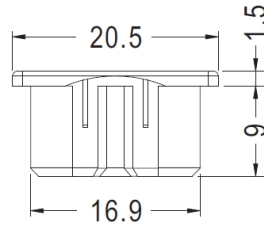

PART NO	PACKAGE
KLCB03	500



- ◆ MATERIAL : ABS (UL)
- ◆ FLAME CLASS : 94HB
- ◆ COLOR : BLACK
- ◆ UNIT: mm

用途：电源插座防尘盖，用于三插座，防尘与保护用。

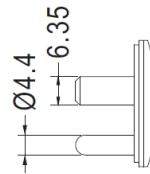
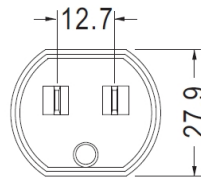
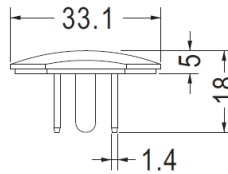

PART NO	PACKAGE
KLCB04	500



- ◆ MATERIAL : PP
- ◆ COLOR : WHITE
- ◆ UNIT: mm

用途：电源插座防尘盖，用于两插座，防尘与保护用。

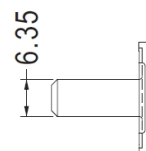
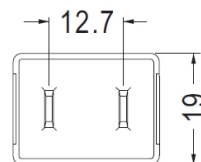
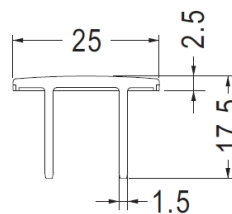

PART NO	PACKAGE
KLCB05	500

电源插座防尘盖 Power Connector Cover



- ◆ MATERIAL : PE
- ◆ COLOR : BLACK
- ◆ UNIT: mm

用途：电源插座防尘盖，用于电源座的防尘与保护。

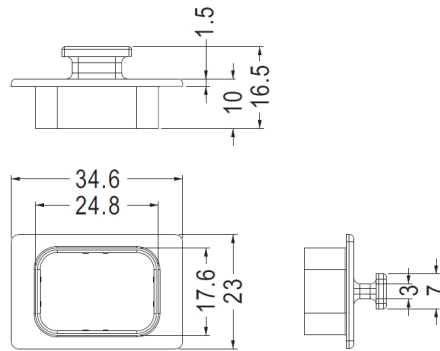

PART NO	PACKAGE
KLCB09	500

光纤连接器护盖 Optical Port Cover

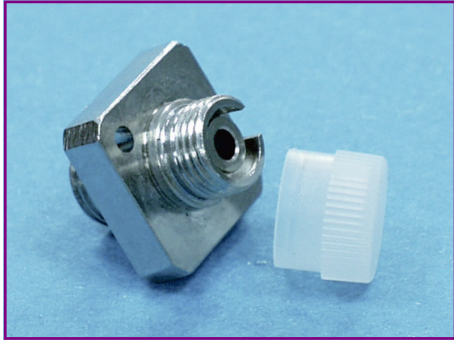

- ◆ MATERIAL : PE
- ◆ COLOR : NATURAL
- ◆ UNIT: mm

用途：光纤连接器护盖，用于光纤连接器的防尘与保护。

PART NO	PACKAGE
GPH01	1000

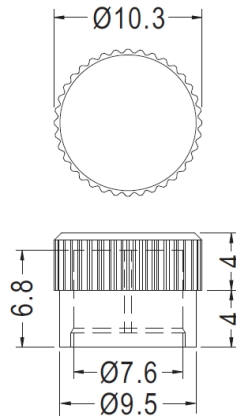

光纤连接器护套 Fiber Optic Connector Cover

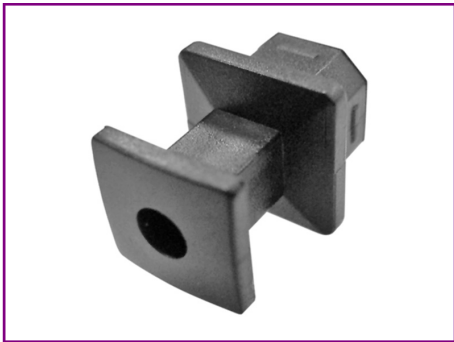

- ◆ MATERIAL : ABS (UL)
- ◆ FLAME CLASS : 94HB
- ◆ COLOR : BLACK
- ◆ UNIT: mm

用途：光纤连接器护套GPH02，用于光纤接头PLT130T防尘与保护。

PART NO	PACKAGE
GPH02	1000

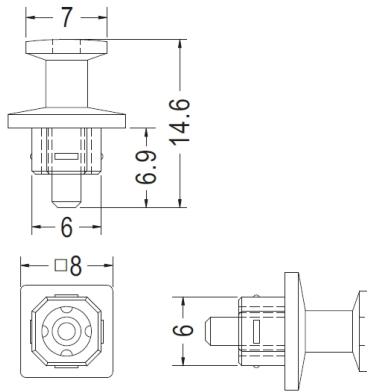

- ◆ MATERIAL : ABS (UL)
- ◆ FLAME CLASS : 94HB
- ◆ COLOR : BLACK
- ◆ UNIT: mm

用途：光纤连接器护套GPH03，用于光纤接头PLT130T防尘与保护。

PART NO	PACKAGE
GPH03	1000

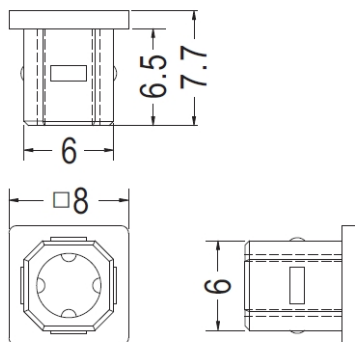

光纤连接器护套 Fiber Optic Connector Cover

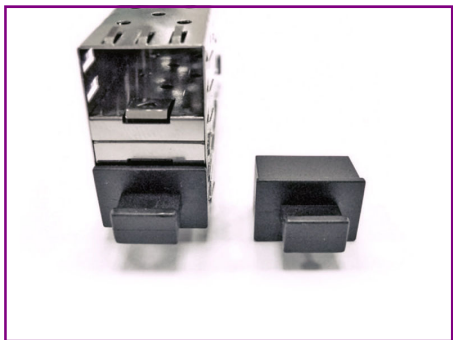

- ◆ MATERIAL : PE
- ◆ COLOR : BLACK
- ◆ UNIT: mm

用途：光纤连接器护套，用于光纤接头防尘与保护。

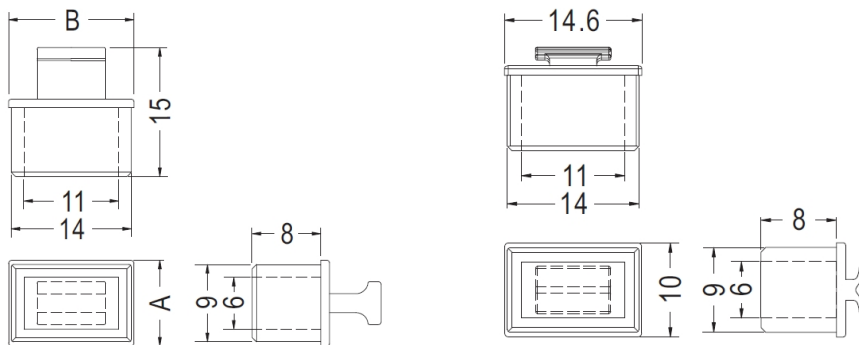

PART NO		PACKAGE	
GPH04	10.0	14.6	1000
GPH08	9.8	14.4	1000

PART NO	PACKAGE
GPH05	1000

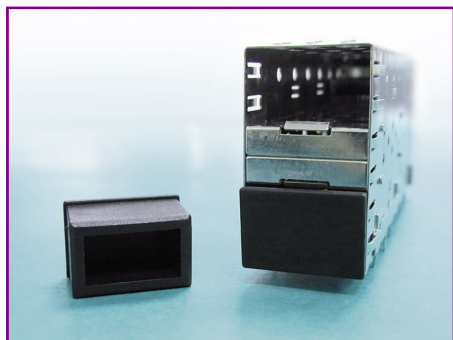

- ◆ MATERIAL : PE
- ◆ COLOR : BLACK
- ◆ UNIT: mm

用途：光纤连接器护套，用于光纤接头防尘与保护。

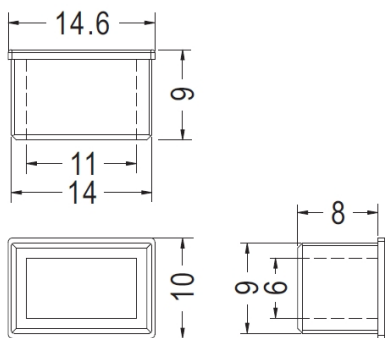

PART NO	PACKAGE
GPH06	1000

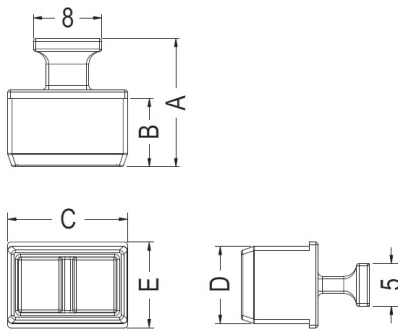

PART NO	A	B	C	D	E	PACKAGE
GPH09	15.0	8.0	14.0	9.0	10.0	1000
GPH10	17.0	10.0	18.5	8.7	10.0	1000

光纤连接器护盖 Optical Port Cover



- ◆ MATERIAL : PE
- ◆ COLOR : BLACK
- ◆ UNIT: mm

用途：光纤连接器护盖，用于光纤连接器的防尘与保护。

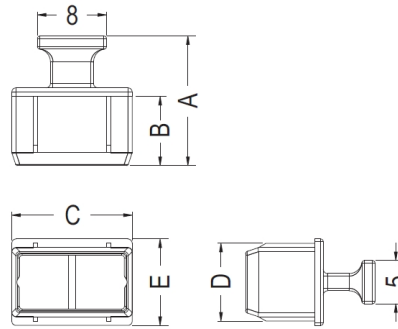

PART NO	A	B	C	D	E	PACKAGE
GPH14	15.0	8.0	14.0	9.0	10.0	1000
GPH15	17.0	10.0	18.5	8.9	10.0	1000
GPH16	15.0	8.0	14.0	9.25	11.0	1000

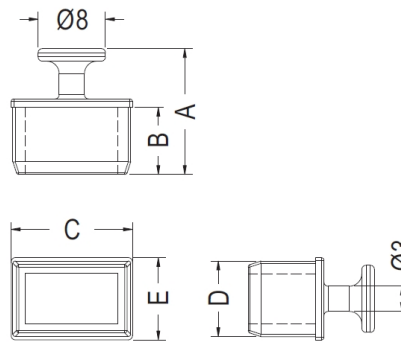

PART NO	A	B	C	D	E	PACKAGE
GPH23	15.0	8.0	14.4	9.0	9.8	1000



- ◆ MATERIAL : PE
- ◆ COLOR : BLACK
- ◆ UNIT: mm

用途：光纤连接器护套，用于光纤接头防尘与保护。

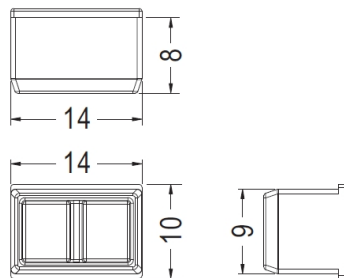

PART NO	PACKAGE
GPH11	1000

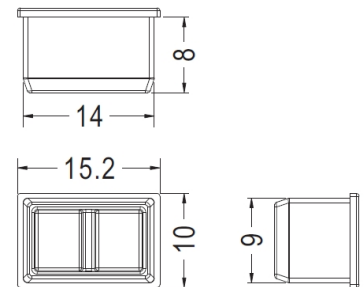

PART NO	PACKAGE
GPH12	1000

光纤连接器护套 Fiber Optic Connector Cover

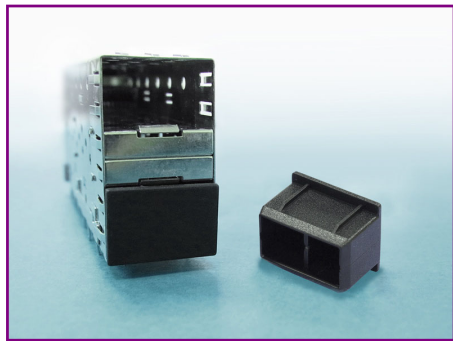

- ◆ MATERIAL : PE
- ◆ COLOR : BLACK
- ◆ UNIT: mm

用途：光纤连接器护套，用于光纤接头防尘与保护。

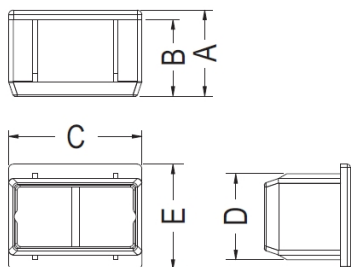

PART NO	A	B	C	D	E	PACKAGE
GPH13	9.0	8.0	14.0	9.25	11.0	1000
GPH24	11.0	10.0	18.5	8.9	10.0	1000

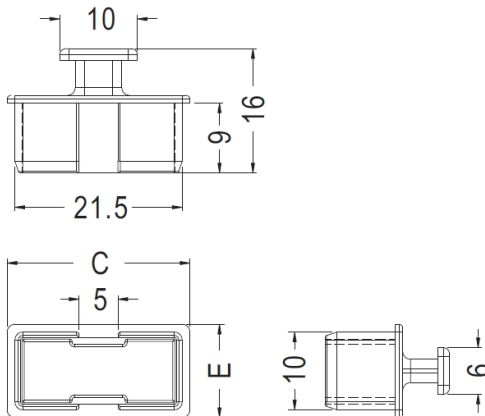
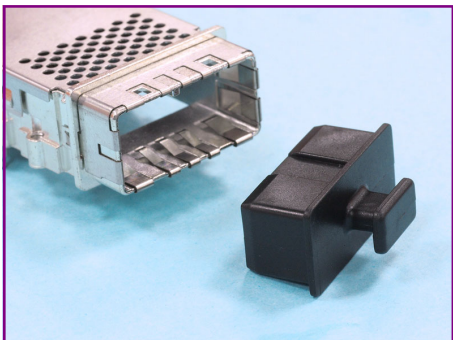

PART NO	C	E	PACKAGE
GPH17	23.5	12.0	1000
GPH19	22.0	11.0	1000



- ◆ MATERIAL : SILICON RUBBER(UL)
 - ◆ FLAME CLASS : 94V-0
 - ◆ COLOR : BLACK
 - ◆ UNIT: mm
- 用途：光纤连接器护套，用于光纤接头防尘与保护。

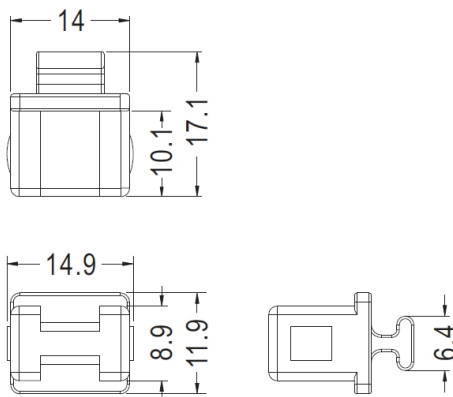

PART NO	PACKAGE
GPH20	1000

光纤连接器护盖 Optical Port Cover

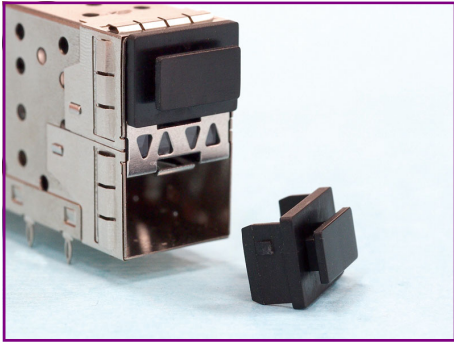

- ◆ MATERIAL : ABS (UL)
- ◆ FLAME CLASS : 94V-0
- ◆ COLOR : BLACK
- ◆ UNIT: mm

用途：光纤连接器护盖，用于光纤连接器的防尘与保护。

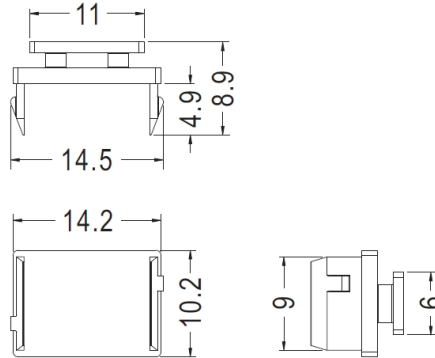

PART NO	PACKAGE
GPH18	1000

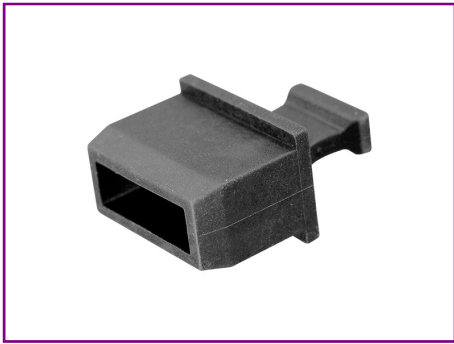

- ◆ MATERIAL : PE
- ◆ COLOR : BLACK
- ◆ UNIT: mm

用途：光纤连接器护套，用于光纤接头防尘与保护，有抗EMI功能。

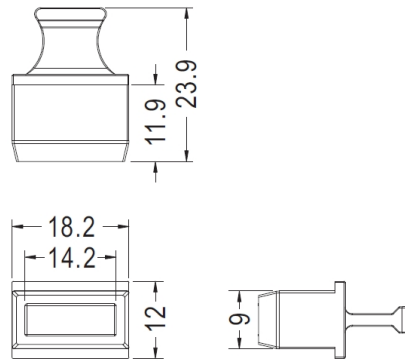

PART NO	PACKAGE
GPH22	1000

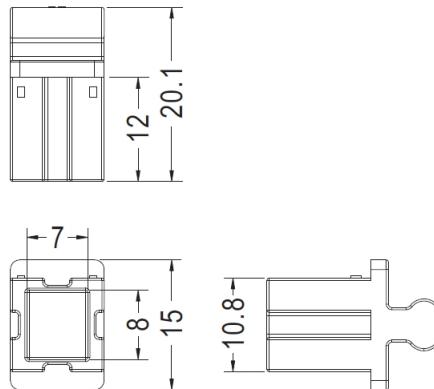
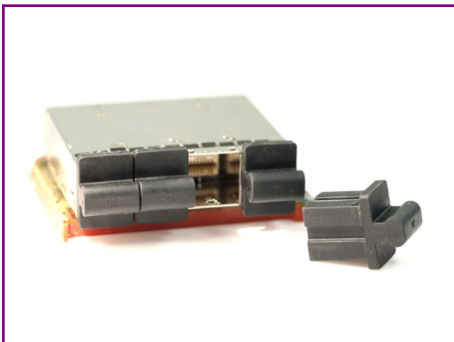

PART NO	PACKAGE
GPH25	1000

光纤防尘盖 Fiber Optic Connector Cover

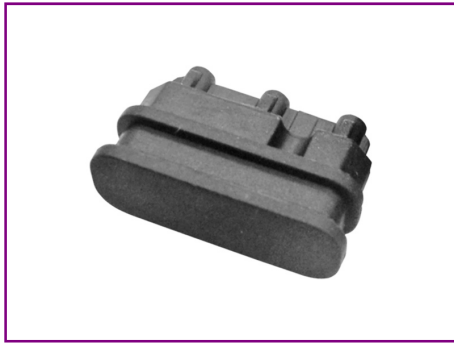

- ◆ MATERIAL : TPE
- ◆ COLOR : BLACK
- ◆ UNIT: mm

用途：光纤防尘盖，用于光纤接头防尘与保护。

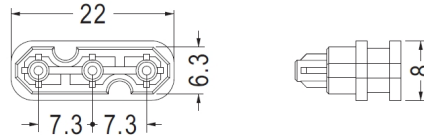
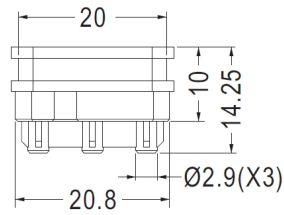

PART NO	PACKAGE
LCER-1	1000



- ◆ MATERIAL : PE
- ◆ COLOR : NATURAL
- ◆ UNIT: mm

用途：光纤防尘盖，用于光纤接头防尘与保护。

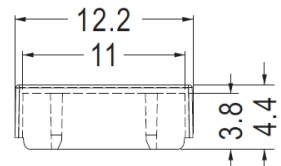
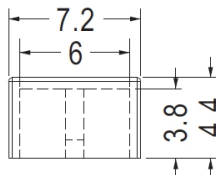
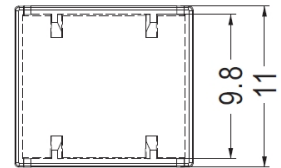
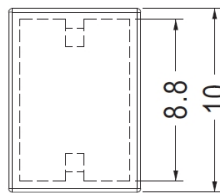

PART NO	PACKAGE
LCER-2	1000

PART NO	PACKAGE
LCER-3	1000

PC板金手指防尘盖 Connector Cover

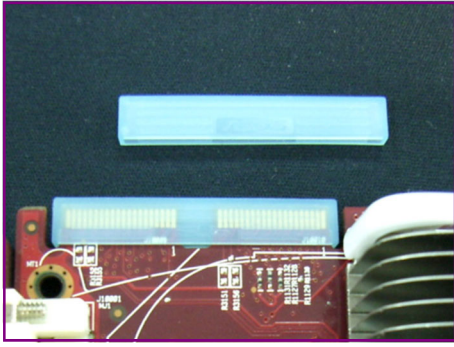

用途：PC板金手指防尘盖，用于PC板金手指防尘与保护。

- ◆ MATERIAL : PE
- ◆ COLOR : BLACK/TRANSPARENT BLUE
- ◆ UNIT: mm

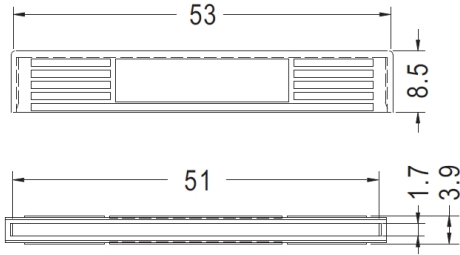

PART NO	PACKAGE
GFR-12	500

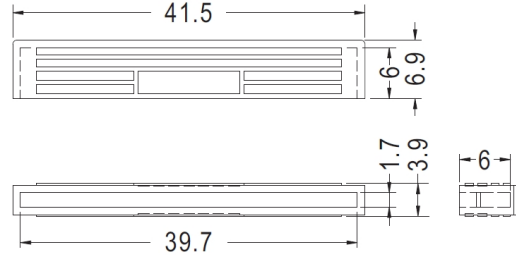

PART NO	PACKAGE
GFR-18	1000

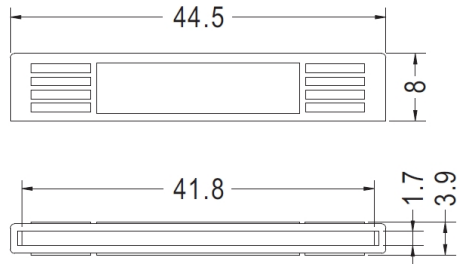

PART NO	PACKAGE
GFR-80	500

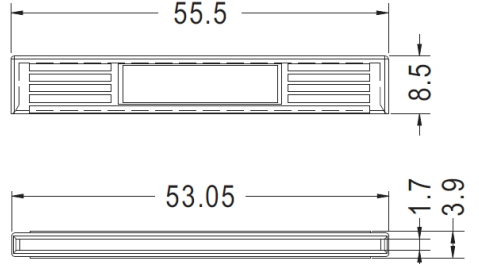

PART NO	PACKAGE
GFR-81	500



- ◆ MATERIAL : PC+ABS(UL)
- ◆ FLAME CLASS : 94V-0
- ◆ COLOR : ORANGE
- ◆ UNIT: mm

用途：PC板金手指防尘盖，用于PC板金手指防尘与保护。

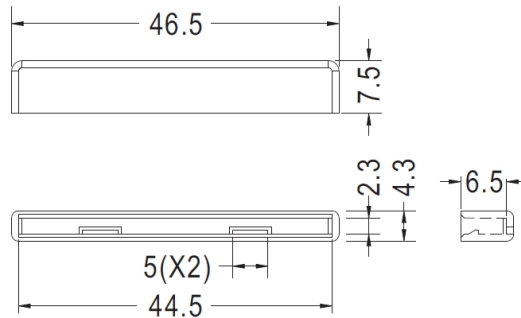

PART NO	PACKAGE
GFR-14	1000

PC板金手指防尘盖 Connector Cover

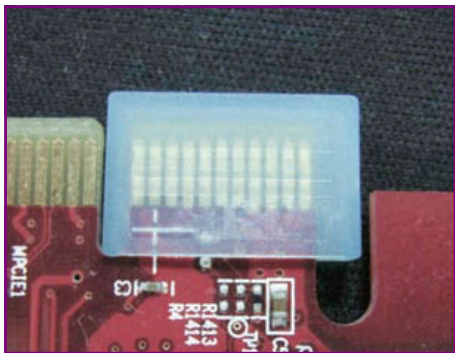

用途：PC板金手指防尘盖，用于PC板金手指防尘与保护。

- ◆ MATERIAL : PE
- ◆ COLOR : NATURAL / TRANSPARENT BLUE
- ◆ UNIT: mm

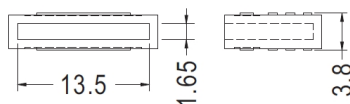
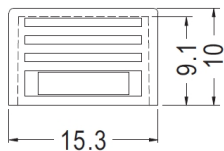

PART NO	PACKAGE
GFR-15	2000

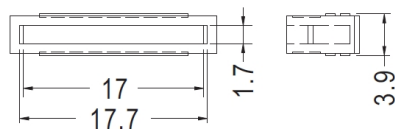
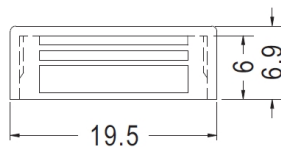

PART NO	PACKAGE
GFR-16	2000

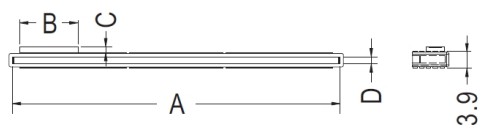
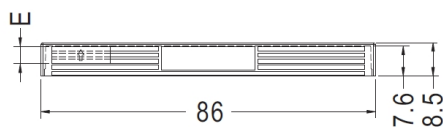
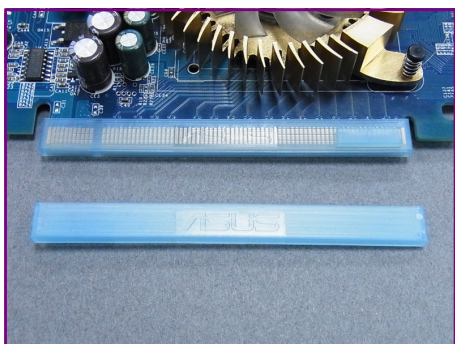

PART NO	A	B	C	D	E	PACKAGE
GFR-19	84.8	-	-	1.7	-	500
GFR-20	84.31	15.0	1.43	1.75	4.16	500

PC板金手指防尘盖 Connector Cover

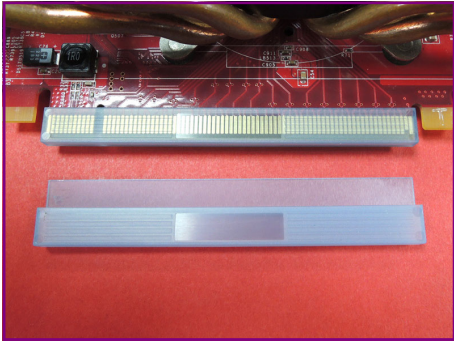

- ◆ MATERIAL : PE
- ◆ COLOR : TRANSPARENT BLUE
- ◆ UNIT: mm

用途：PC板金手指防尘盖，用于PC板金手指防尘与保护。

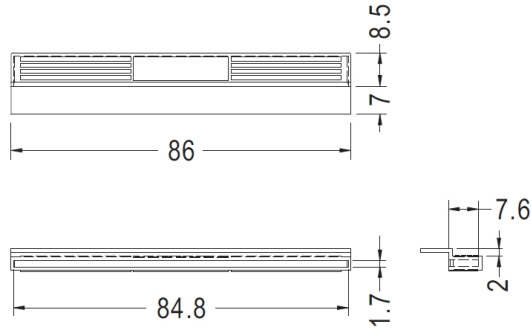

PART NO	PACKAGE
GFR-23	1000



- ◆ MATERIAL : NYLON 66(UL)
- ◆ FLAME CLASS : 94V-0 / 94V-2
- ◆ COLOR : BLUE
- ◆ UNIT: mm

用途：PC板金手指防尘盖，用于PC板金手指防尘与保护。

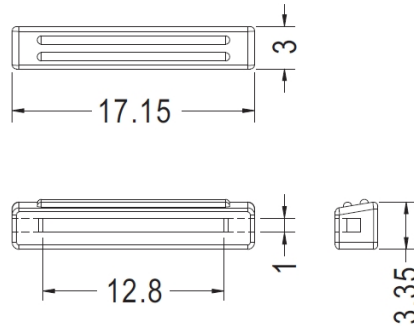

PART NO	PACKAGE
GFR-63	2000

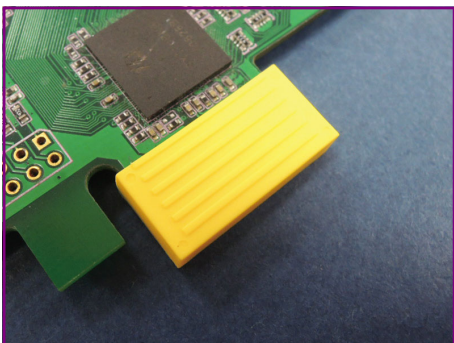

- ◆ MATERIAL : PE
- ◆ COLOR : YELLOW
- ◆ UNIT: mm

用途：PC板金手指防尘盖，用于PC板金手指防尘与保护。

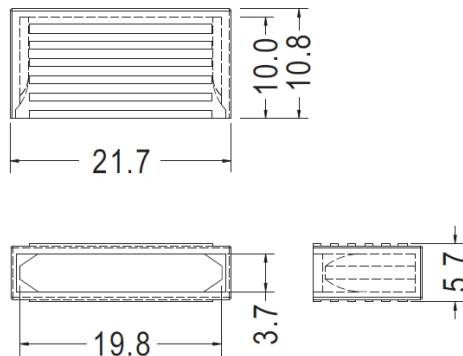

PART NO	PACKAGE
GFR-68	1000

PC板金手指防尘盖 Connector Cover

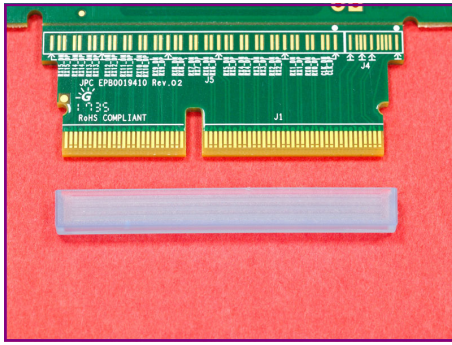

- ◆ MATERIAL : PE
- ◆ COLOR : NATURAL/TRANSPARENT BLUE
- ◆ UNIT: mm

用途: PC板金手指防尘盖, 用于PC板金手指防尘与保护。

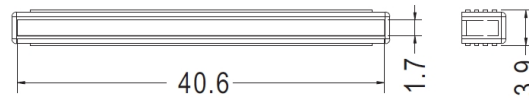
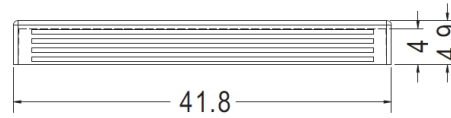

PART NO	PACKAGE
GFR-79	1000

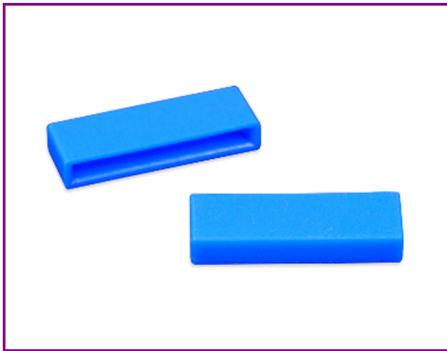

- ◆ MATERIAL : PE
- ◆ COLOR : BLUE
- ◆ UNIT: mm

用途: PC板金手指防尘盖, 用于PC板金手指防尘与保护。

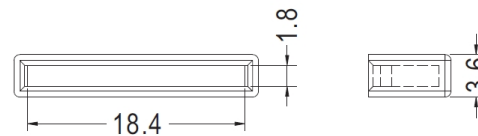
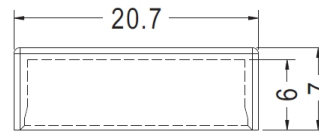

PART NO	PACKAGE
GFR-82	2000

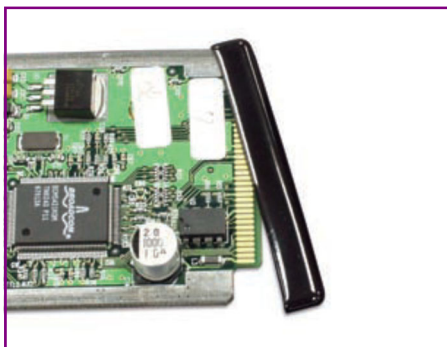

- ◆ MATERIAL : SOFT P.V.C
- ◆ COLOR : BLACK
- ◆ UNIT: mm

用途: PC板金手指防尘盖, 用于PC板金手指防尘与保护。

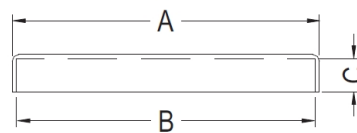

THICKNESS 1.7~1.8

PART NO	A	B	C	D	PACKAGE
VFH-2	51.8	49.8	11.5	1.0	1000
VFH-3	65.9	63.5	7.0	1.2	1000
VFH-4	91.4	89.0	10.0	1.2	1000

HDMI防尘盖 Connector Cover Micro HDMI防尘盖 Mini SAS HD防尘盖



- ◆ MATERIAL : TPE
- ◆ COLOR : BLACK
- ◆ UNIT: mm

用途：Micro HDMI防尘盖，用于Micro HDMI端子座的防尘盖、美观。

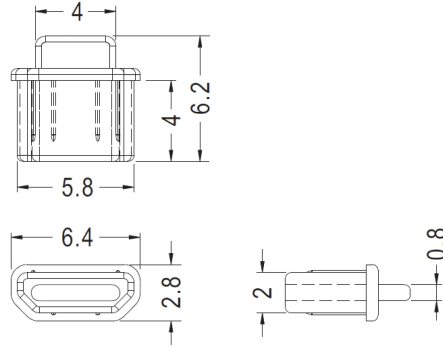

PART NO	PACKAGE
HDMI-M1	1000

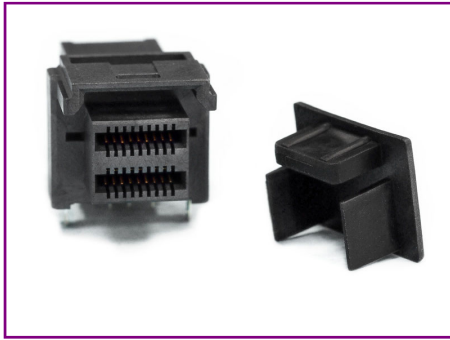

- ◆ MATERIAL : TPE
- ◆ COLOR : BLACK
- ◆ UNIT: mm

用途：Mini SAS HD防尘盖，用于Mini SAS HD接头防尘与保护。

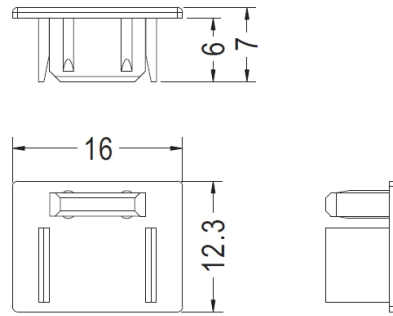

PART NO	PACKAGE
HDMI-M2	1000

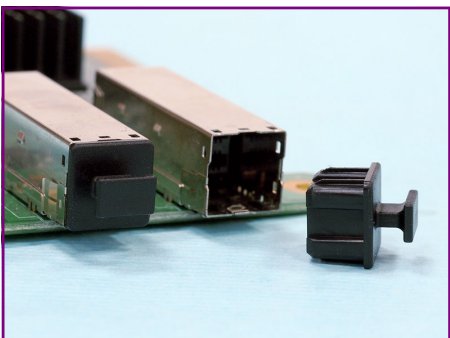

- ◆ MATERIAL : PE
- ◆ COLOR : BLACK
- ◆ UNIT: mm

用途：Mini SAS HD防尘盖，用于Mini SAS HD接头防尘与保护。

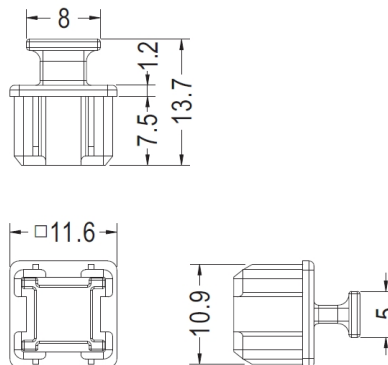

PART NO	PACKAGE
HDMI-M3	1000

Mini数位端子防尘盖 Connector Cover

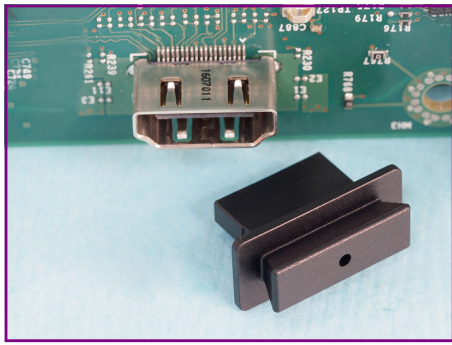

- ◆ MATERIAL : PE
- ◆ COLOR : BLACK
- ◆ UNIT: mm

用途: Mini数位端子防尘盖, 用于 Mini数位端子之防尘盖、美观。

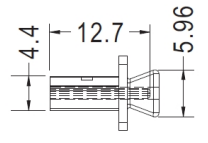
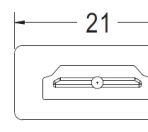
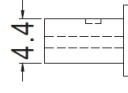
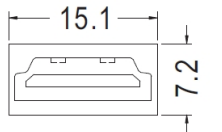
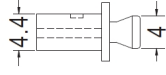
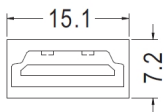
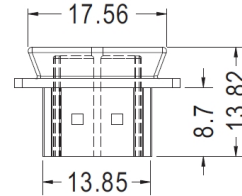
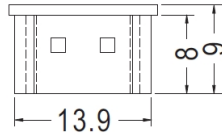
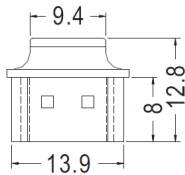

PART NO	PACKAGE
HDMI-C1	1000

PART NO	PACKAGE
HDMI-C2	1000

PART NO	PACKAGE
HDMI-C7	1000



- ◆ MATERIAL : RUBBER
- ◆ COLOR : BLACK
- ◆ UNIT: mm

用途: Mini数位端子防尘盖, 用于 Mini数位端子之防尘盖、美观。

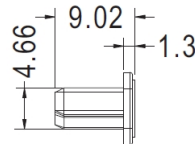
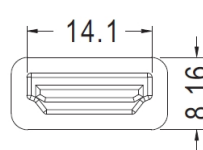
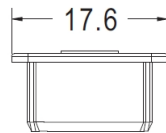

PART NO	PACKAGE
HDMI-C6	1000



- ◆ MATERIAL : PE
- ◆ COLOR : NATURAL/TRANSPARENT BLUE
- ◆ UNIT: mm

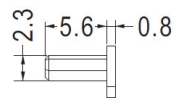
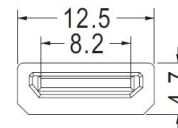
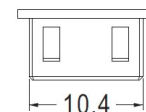
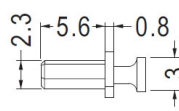
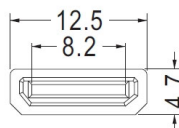
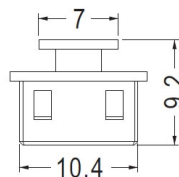

PART NO	PACKAGE
HDMI-C8	2000

PART NO	PACKAGE
HDMI-C9	2000

HDMI防尘盖 Connector Cover



- ◆ MATERIAL : NYLON 66(UL)
- ◆ FLAME CLASS : 94V-0 / 94V-2
- ◆ COLOR : BLACK/NATURAL
- ◆ UNIT: mm

用途：HDMI防尘盖，用于HDMI端子座之防尘、美观，具有封孔功能，避免错误使用插拔。

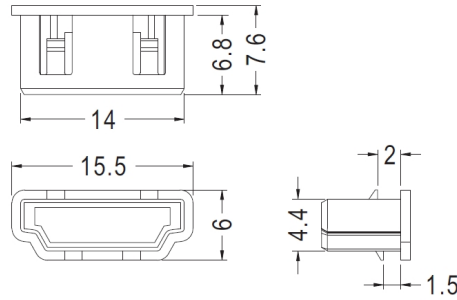

PART NO	PACKAGE
HDMI-C3	1000



- ◆ MATERIAL : PE
- ◆ COLOR : BLACK
- ◆ UNIT: mm

用途：HDMI防尘盖，用于HDMI端子座之防尘、美观，具有封孔功能，避免错误使用插拔。

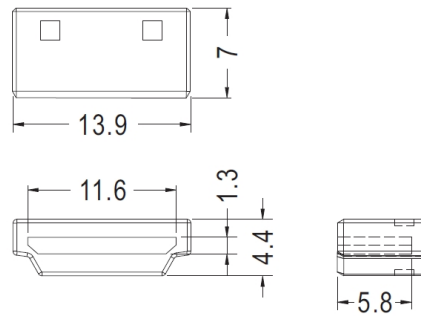

PART NO	PACKAGE
HDMI-C4	1000

HDMI端子盖 HDMI Cover



- ◆ MATERIAL : PE
- ◆ COLOR : BLACK
- ◆ UNIT: mm

用途：HDMI端子盖，用于HDMI端子上保护插头，防氧化。

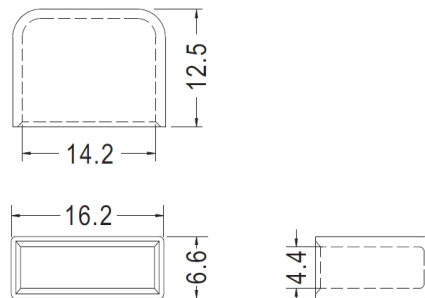

PART NO	PACKAGE
HDMI-C5	1000

汽车点烟器防尘盖 Connector Cover



- ◆ MATERIAL : TPE
- ◆ COLOR : BLACK
- ◆ UNIT: mm

用途：汽车点烟器防尘盖，用于汽车点烟器防尘与保护用。

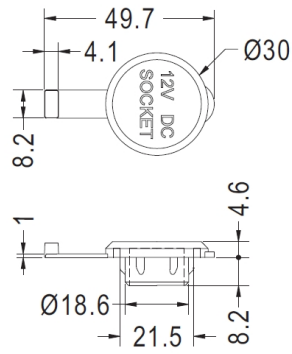

PART NO	PACKAGE
GFR-38	500

BBU防尘盖 Connector Cover

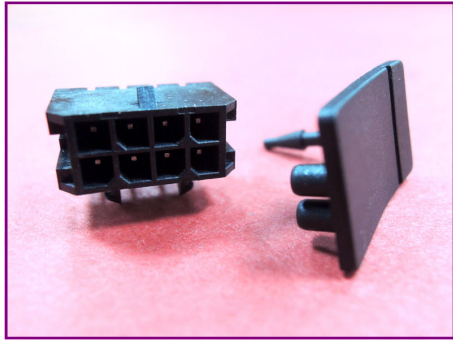

- ◆ MATERIAL : TPU
- ◆ COLOR : BLACK
- ◆ UNIT: mm

用途：BBU防尘盖，用于BBU的防尘与保护用。

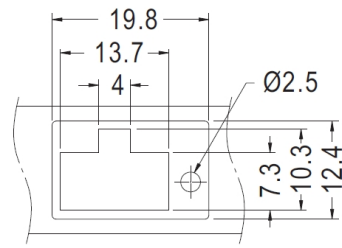
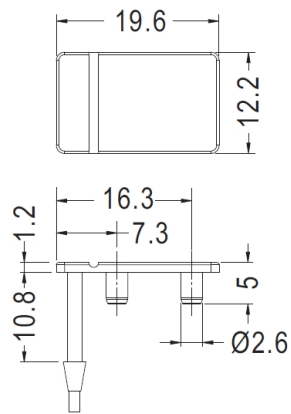

MOUNTING HOLE

PART NO	PACKAGE
GFR-72	1000

DVI防尘盖 Hole Plug



- ◆ MATERIAL : PE
- ◆ COLOR : BLACK
- ◆ UNIT: mm

用途：DVI防尘盖，可将多余的机壳出线口遮盖，装配容易。

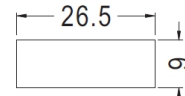
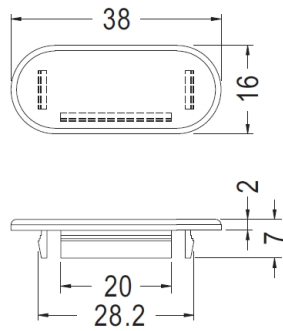

MOUNTING HOLE THICKNESS 0.6~1.2

PART NO	PACKAGE
DVI-1	500



- ◆ MATERIAL : NYLON 66(UL)
- ◆ FLAME CLASS : 94V-0 / 94V-2
- ◆ COLOR : BLACK/NATURAL
- ◆ UNIT: mm

用途：可将多余的机壳出线口遮盖，装配容易。

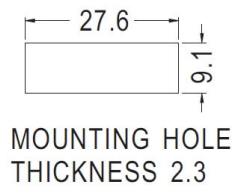
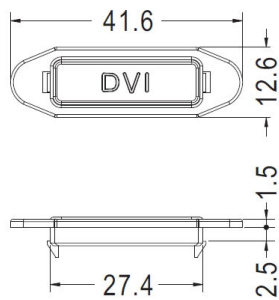

MOUNTING HOLE THICKNESS 2.3

PART NO	PACKAGE
DVI-2	1000

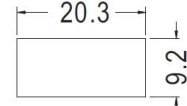
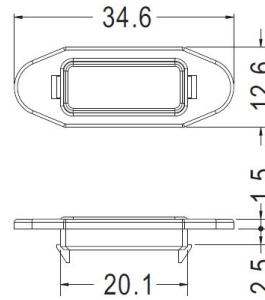

MOUNTING HOLE THICKNESS 2.3

PART NO	PACKAGE
DVI-3	1000

连接器盖 Connector Cover

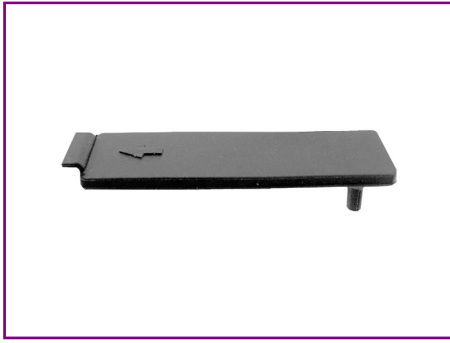

- ◆ MATERIAL : TPU
- ◆ COLOR : BLACK/WHITE
- ◆ UNIT: mm

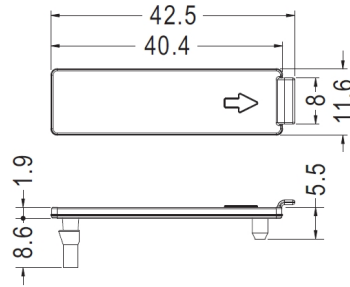

用途：连接器盖，用于连接器之防尘与保护用。

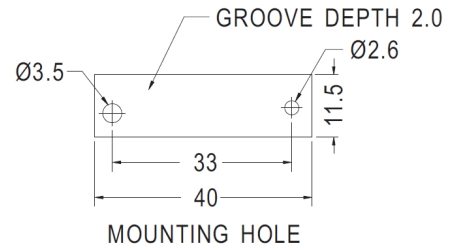

PART NO	PACKAGE
KL001	500



- ◆ MATERIAL : SILICON RUBBER
- ◆ COLOR : BLACK
- ◆ UNIT: mm

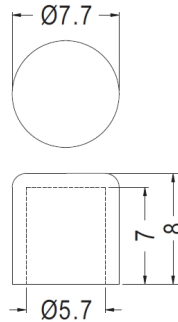

用途：连接器盖，用于天线连接器之防尘与保护。

PART NO	PACKAGE
GFR-75	1000

SIM Card Cap防尘盖 Connector Cover



- ◆ MATERIAL : TPU
- ◆ COLOR : BLACK/WHITE
- ◆ UNIT: mm

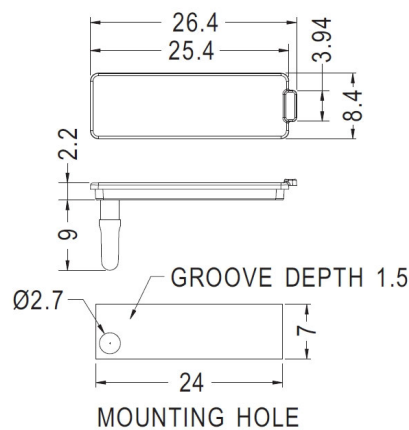

用途：SIM Card Cap防尘盖，用于SIM Card Cap防尘与保护用。

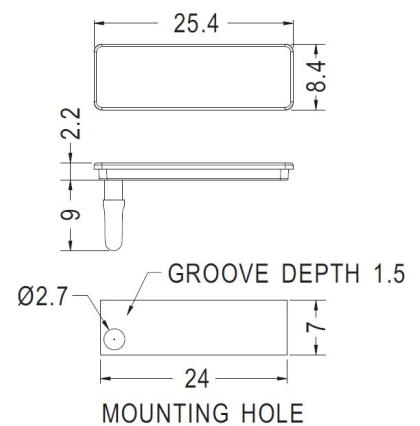

PART NO	PACKAGE
GFR-43	500

PART NO	PACKAGE
GFR-66	500

SD防尘盖 SD Connector Cover



- ◆ MATERIAL : TPE
- ◆ COLOR : BLACK
- ◆ UNIT: mm

用途：SD防尘盖，用于SD卡防尘与保护用。

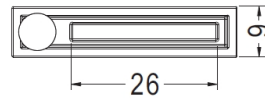
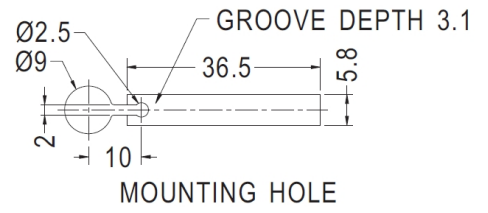
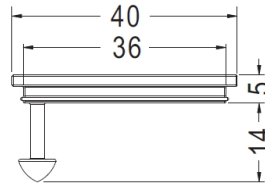

PART NO	PACKAGE
SD-C1	1000

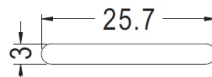
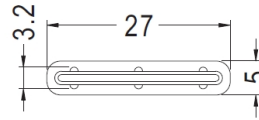
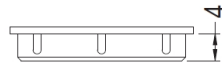

MOUNTING HOLE

PART NO	PACKAGE
SD-C2	1000

KVM防尘盖 Connector Cover



- ◆ MATERIAL : PE
- ◆ COLOR : BLACK
- ◆ UNIT: mm

用途: KVM防尘盖, 用于KVM连接器之防尘与保护。

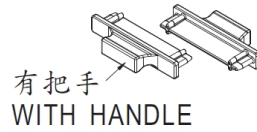
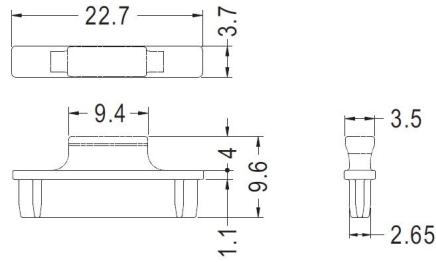

KVM-1

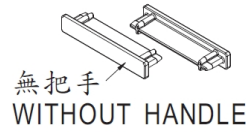

KVM-2

PART NO	PACKAGE
KVM-1	1000
KVM-2	1000

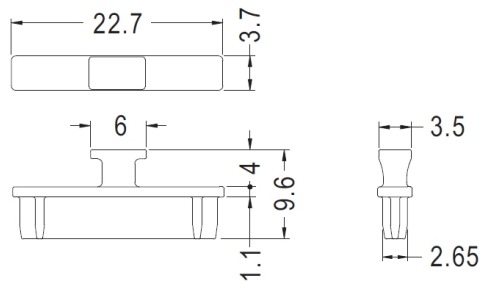

PART NO	PACKAGE
KVM-3	1000

CF防尘盖 Connector Cover

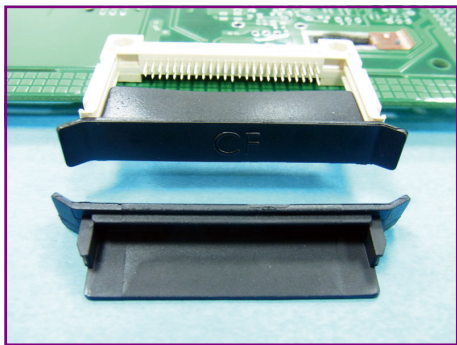

- ◆ MATERIAL : TPU
- ◆ COLOR : BLACK
- ◆ UNIT: mm

用途：CF防尘盖，用于CF连接器之防尘与保护。

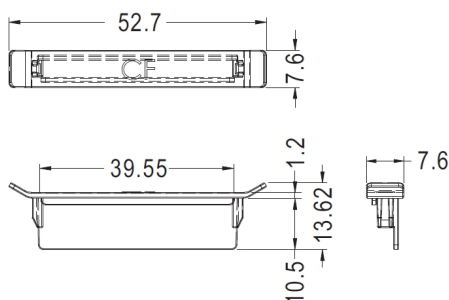

PART NO	PACKAGE
CF-C1	500

防尘盖 Connector Cover



- ◆ MATERIAL : PE
- ◆ COLOR : NATURAL
- ◆ UNIT: mm

用途：防尘盖，用于USB接头防尘与保护。

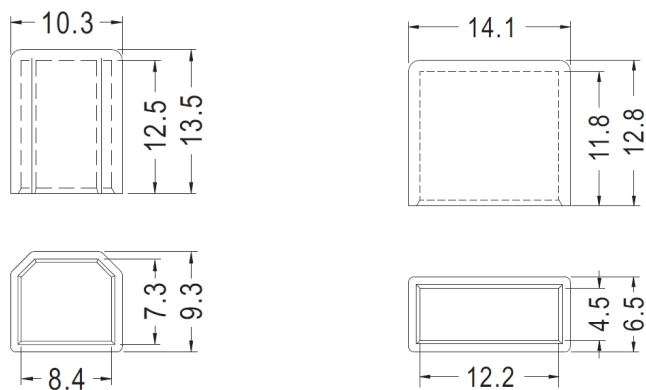

PART NO	PACKAGE
GFR-51	1000

PART NO	PACKAGE
GFR-52	1000

防尘盖 S-Video Plug Cover



- ◆ MATERIAL : PE
- ◆ COLOR : NATURAL
- ◆ UNIT: mm

用途：防尘盖，用于连接器之防尘与保护。

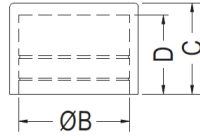
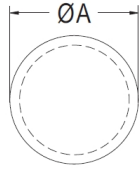

PART NO	A	B	C	D	PACKAGE
GFR-45	15.8	13.4	11.2	10.0	500
GFR-46	10.7	9.0	9.6	8.6	1000
GFR-47	10.3	8.4	8.0	7.0	1000

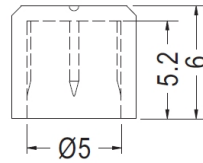

PART NO	PACKAGE
GFR-49	1000



- ◆ MATERIAL : PE
- ◆ COLOR : NATURAL/WHITE/BLACK
- ◆ UNIT: mm

用途：防尘盖，用于连接器之防尘与保护。

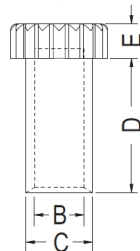
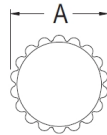

PART NO	A	B	C	D	E	PACKAGE
GFR-6	4.5	2.3	3.3	3.5	3.2	1000
GFR-44	5.7	2.85	3.85	7.8	2.0	1000

防尘盖 Connector Cover



- ◆ MATERIAL : PE
- ◆ COLOR : BLACK / RED
- ◆ UNIT: mm

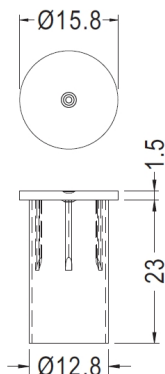

用途：防尘盖，用于连接器之防尘与保护。

PART NO	PACKAGE
GFR-48	1000

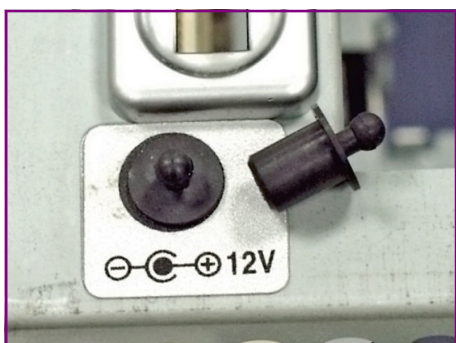

- ◆ MATERIAL : RUBBER
- ◆ COLOR : BLACK
- ◆ UNIT: mm

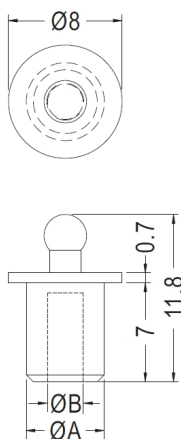

用途：防尘盖，用于电源连接器防尘与保护。

PART NO	A	B	PACKAGE
GFR-17	4.0	2.0	1000
GFR-21	5.5	2.5	1000



- ◆ MATERIAL : PP (UL)
- ◆ FLAME CLASS: 94HB
- ◆ COLOR : BLACK
- ◆ UNIT: mm

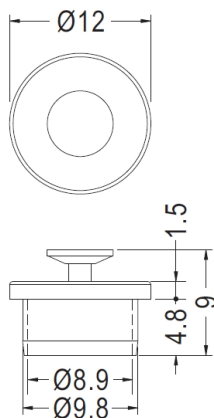

用途：防尘盖，用于连接器的防尘与保护。

PART NO	PACKAGE
GFR-50	1000

防尘盖 Connector Cover



- ◆ MATERIAL : NYLON 66(UL)
- ◆ FLAME CLASS : 94V-0 / 94V-2
- ◆ COLOR : BLACK/NATURAL
- ◆ UNIT: mm

用途：防尘盖，用于连接器之防尘与保护。

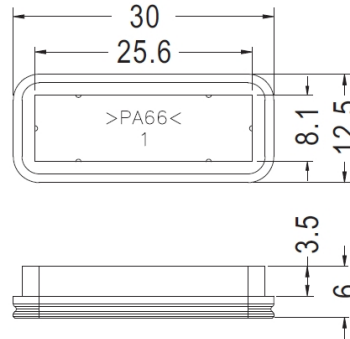

PART NO	PACKAGE
GFR-58	1000

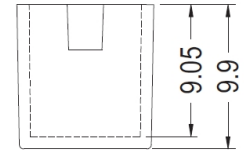
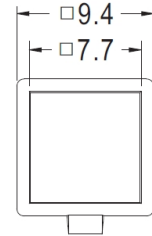
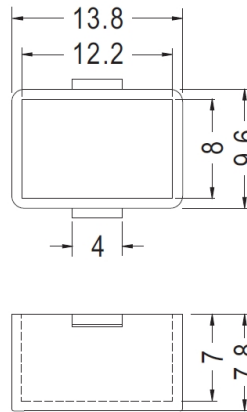

PART NO	PACKAGE
GFR-22	1000

PART NO	PACKAGE
GFR-62	1000



- ◆ MATERIAL : PE
- ◆ COLOR : BLACK
- ◆ UNIT: mm

用途：防尘盖，用于汽车连接器防尘与保护。

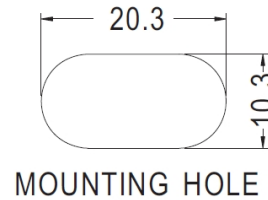
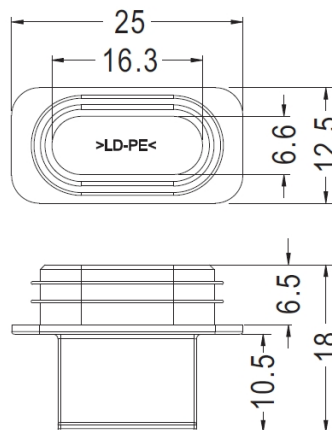

PART NO	PACKAGE
GFR-34	1000

防尘盖 Connector Cover



- ◆ MATERIAL : NBR
- ◆ COLOR : BLACK
- ◆ UNIT: mm

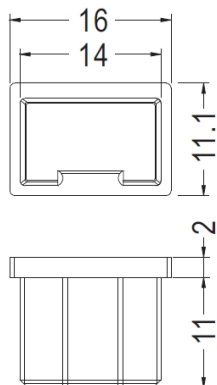

用途：防尘盖，用于连接器之防尘与保护。

PART NO	PACKAGE
GFR-5	1000



- ◆ MATERIAL : PBT (UL)
- ◆ FLAME CLASS: 94V-0
- ◆ COLOR : NATURAL
- ◆ UNIT: mm

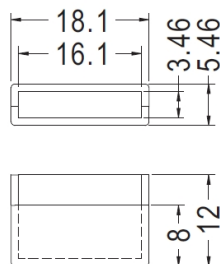

用途：防尘盖，用于连接器的防尘与保护。

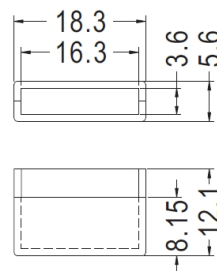

PART NO	PACKAGE
GFR-31	500

PART NO	PACKAGE
GFR-32	500

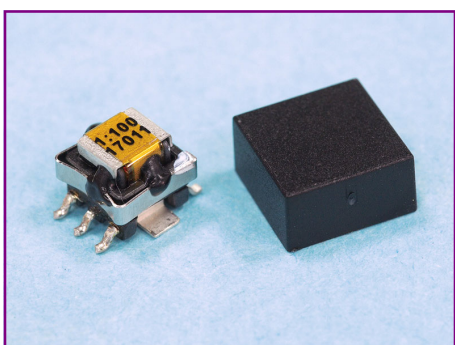

- ◆ MATERIAL : NYLON 66 (UL)
- ◆ FLAME CLASS: 94V-0/94V-2
- ◆ COLOR : BLACK/NATURAL
- ◆ UNIT: mm

用途：防尘盖，用于电子零件晶体之防尘与保护。

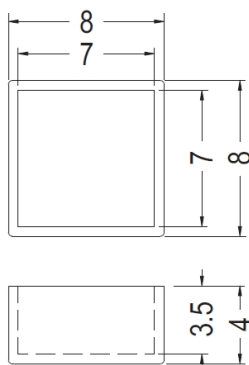

PART NO	PACKAGE
GFR-70	1000

防尘盖 Connector Cover



- ◆ MATERIAL : NYLON 66(UL)
- ◆ FLAME CLASS : 94V-0 / 94V-2
- ◆ COLOR : BLACK/NATURAL
- ◆ UNIT: mm

用途：防尘盖，用于防尘与保护用。

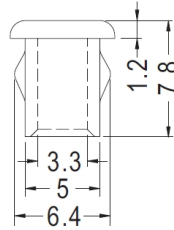
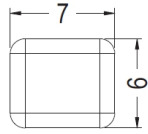

PART NO	PACKAGE
GFR-33	1000

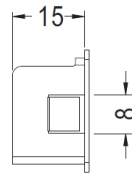
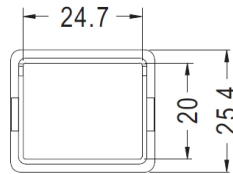
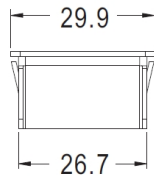

用途：防尘盖，用于机板上，保护电源插座避免刮伤。

PART NO	PACKAGE
GFR-4	1000



- ◆ MATERIAL : ABS(UL)
- ◆ FLAME CLASS : 94HB
- ◆ COLOR : BLACK
- ◆ UNIT: mm

用途：防尘盖，用于连接器之防尘与保护。

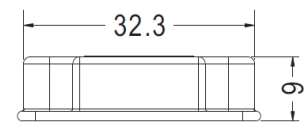
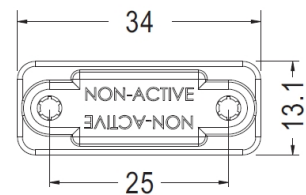
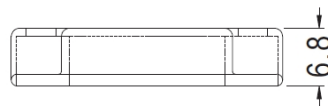
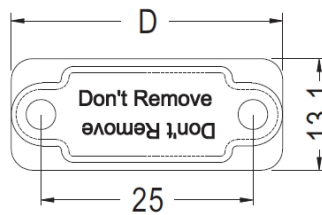

PART NO	D	PACKAGE
GFR-35	34.0	1000
GFR-36	32.0	1000

PART NO	PACKAGE
GFR-78	500

防尘盖 Connector Cover



- ◆ MATERIAL : ABS (UL)
- ◆ FLAME CLASS: 94VHB
- ◆ COLOR : BLACK
- ◆ UNIT: mm

用途：防尘盖，用于防尘与保护。

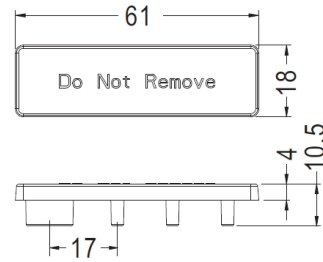

PART NO	PACKAGE
GFR-37	500



- ◆ MATERIAL : NYLON 66 (UL)
- ◆ FLAME CLASS: 94V-0/94V-2
- ◆ COLOR : NATURAL/BLACK
- ◆ UNIT: mm

用途：防尘盖，用于防尘与保护用。

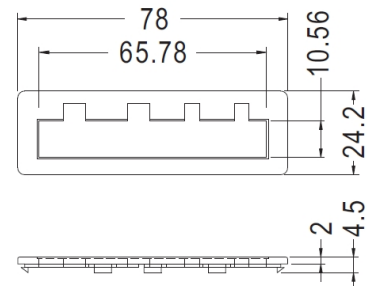
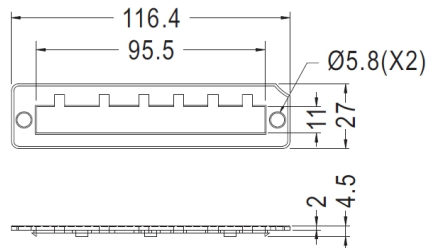

PART NO	PACKAGE
GFR-56	500

PART NO	PACKAGE
GFR-57	500

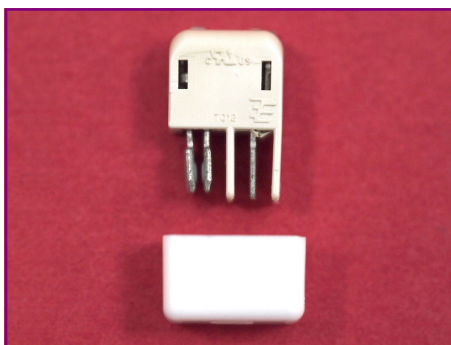

- ◆ MATERIAL : PBT (UL)
- ◆ FLAME CLASS: 94V-0
- ◆ COLOR : NATURAL
- ◆ UNIT: mm

用途：防尘盖，用于连接器防尘与保护用。

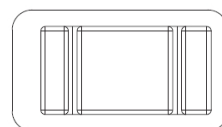
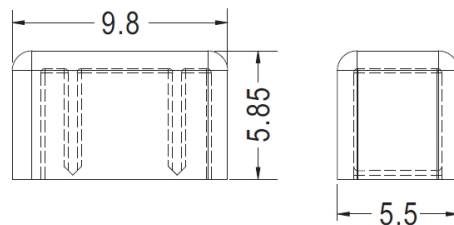

PART NO	PACKAGE
GFR-13	1000

防尘盖 Connector Cover



- ◆ MATERIAL : NYLON 66(UL)
- ◆ FLAME CLASS : 94V-0 / 94V-2
- ◆ COLOR : BLACK/NATURAL
- ◆ UNIT: mm

用途：防尘盖，用于塑料机壳螺丝孔之塞头。

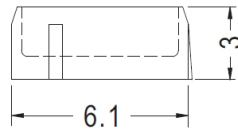
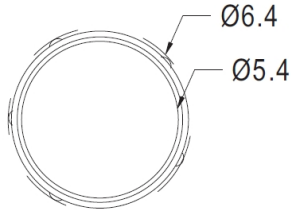

PART NO	PACKAGE
GFR-8	2000



- ◆ MATERIAL : NYLON 66(UL)
- ◆ FLAME CLASS : 94V-0 / 94V-2
- ◆ COLOR : BLACK
- ◆ UNIT: mm

用途：防尘盖，使用于PCI-E X1连接器的防尘与保护用。

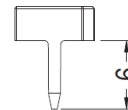
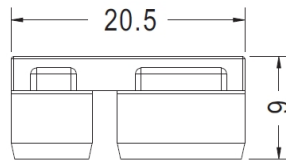

PART NO	PACKAGE
GFR-83	1000



- ◆ MATERIAL : PC (UL)
- ◆ FLAME CLASS : 94V-0
- ◆ COLOR : NATURAL
- ◆ UNIT: mm

用途：防尘盖，用于防尘与保护用。

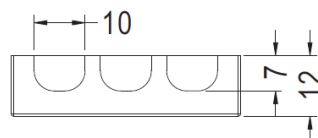
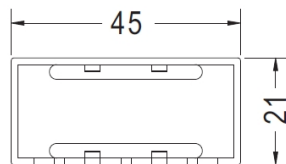

PART NO	PACKAGE
GFR-84	200

端子盖 Connector Cover

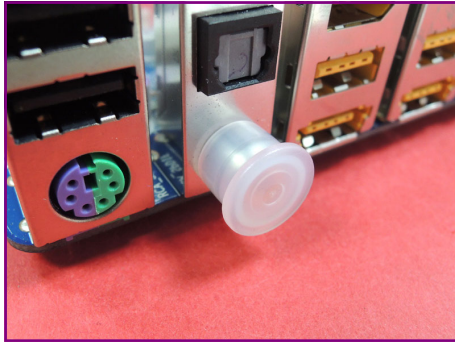

- ◆ MATERIAL : PE
- ◆ COLOR : NATURAL
- ◆ UNIT: mm

用途：RCA端子盖，用于连接器RCA端子之防尘与保护用。

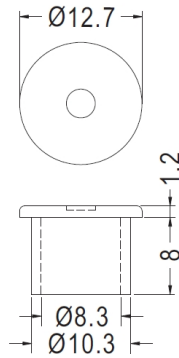

PART NO	PACKAGE
DZGR-11	1000

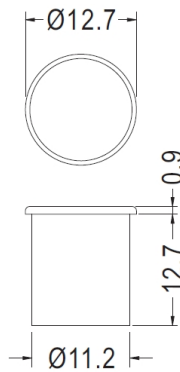

PART NO	PACKAGE
DZGR-05	1000

用途：F端子盖，用于F端子之防尘与保护用。



- ◆ MATERIAL : PE
- ◆ COLOR : NATURAL / BLACK
- ◆ UNIT: mm

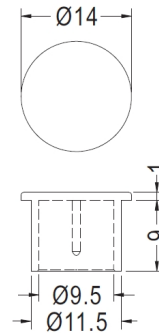

PART NO	PACKAGE
DZGR-06	1000



- ◆ MATERIAL : PE
- ◆ COLOR : NATURAL
- ◆ UNIT: mm

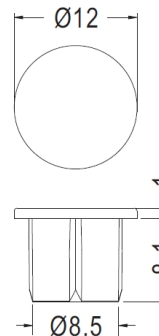

PART NO	PACKAGE
DZGR-01	1000

端子盖 Connector Cover

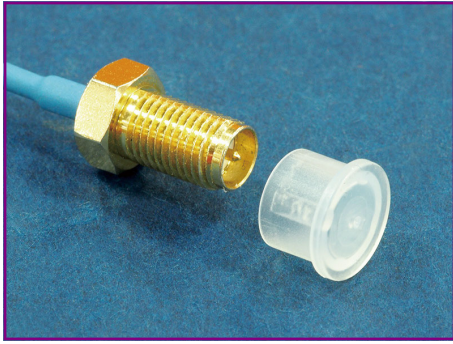

- ◆ MATERIAL : PE
- ◆ COLOR : BLACK/NATURAL
- ◆ UNIT: mm

用途：天线端子盖，用于天线端子之防尘与保护。

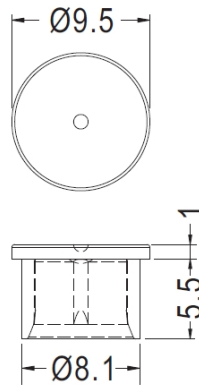

PART NO	PACKAGE
DZGR-12	1000

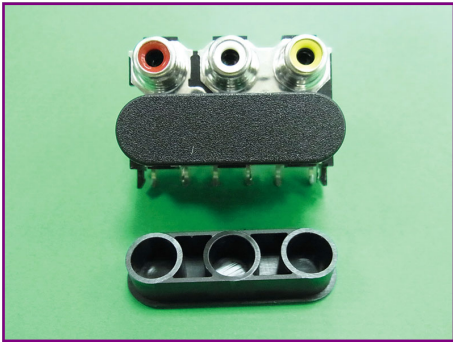

- ◆ MATERIAL : PP (UL)
- ◆ FLAME CLASS : 94HB
- ◆ COLOR : BLACK
- ◆ UNIT: mm

用途：端子盖，用于端子之防尘与保护。

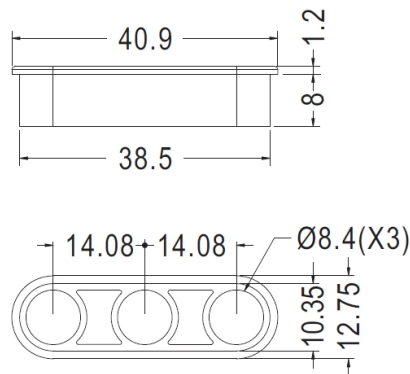

PART NO	PACKAGE
DZGR-07	1000

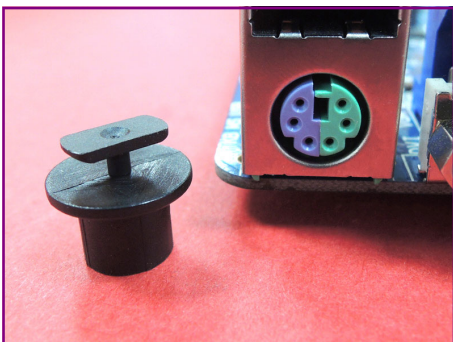

- ◆ MATERIAL : PP
- ◆ COLOR : BLACK
- ◆ UNIT: mm

用途：端子盖，用于防尘与保护用。

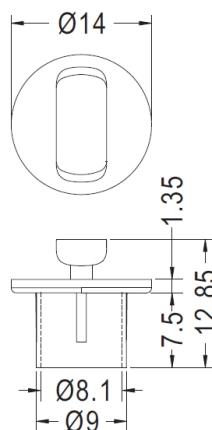

PART NO	PACKAGE
DZGR-08	1000

S端子盖 S-Video Plug Cover



- ◆ MATERIAL : PP
- ◆ COLOR : NATURAL/BLACK
- ◆ UNIT: mm

用途：S端子盖，S端子之防尘盖、美观。

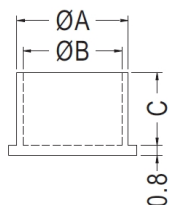
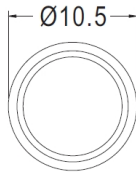

PART NO	A	B	C	PACKAGE
SCVD001	9.0	8.0	9.6	1000
SCVD002	9.1	8.1	6.0	1000

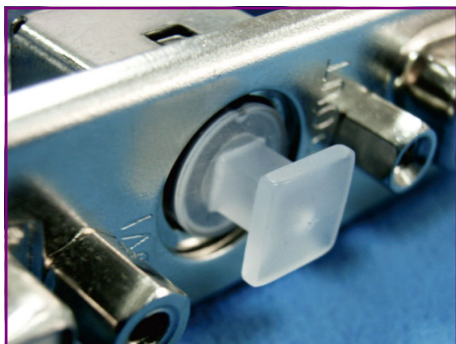

- ◆ MATERIAL : PP
- ◆ COLOR : NATURAL
- ◆ UNIT: mm

用途：S端子盖，S端子之防尘盖、美观。

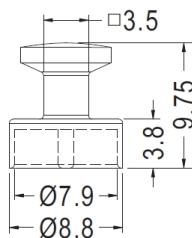
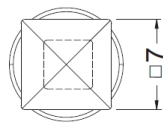

PART NO	PACKAGE
SCVD003	1000



- ◆ MATERIAL : PE
- ◆ COLOR : NATURAL
- ◆ UNIT: mm

用途：S端子盖，S端子之防尘盖、美观。

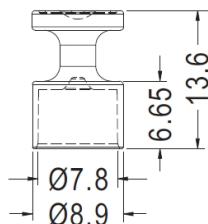
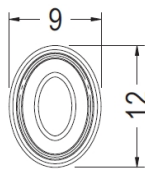

PART NO	PACKAGE
SCVD004	1000

平衡端子盖 Balanced Port Cover



- ◆ MATERIAL : PE/PP
- ◆ COLOR : COMPUTER
- ◆ UNIT: mm

用途：平衡端子盖，平衡端子XLR座之防尘盖、美观。

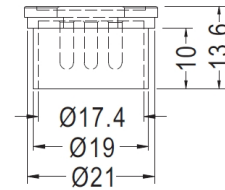
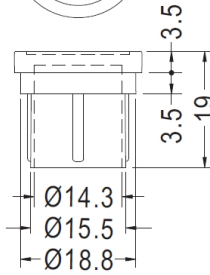
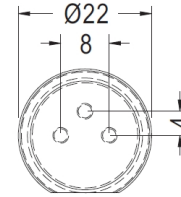
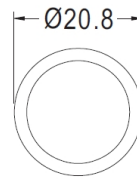

PART NO	PACKAGE
NXLR-1	250

PART NO	PACKAGE
NXLR-2	250



- ◆ MATERIAL : NYLON 66(UL)
- ◆ FLAME CLASS : 94V-0 / 94V-2
- ◆ COLOR : BLACK/NATURAL
- ◆ UNIT: mm

用途：端子盖，用于端子之绝缘。

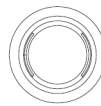
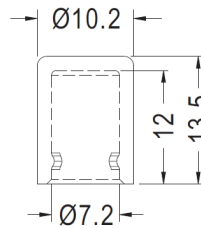

PART NO	PACKAGE
DZGR-02	1000

BNC绝缘座 BNC Round Housing

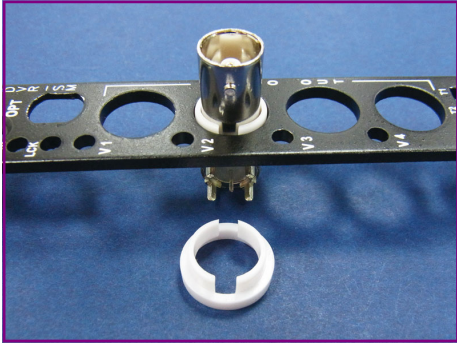

- ◆ MATERIAL : ABS (UL)
- ◆ FLAME CLASS : 94HB
- ◆ COLOR : NATURAL
- ◆ UNIT: mm

用途: BNC绝缘座, 用于BNC端子之绝缘。

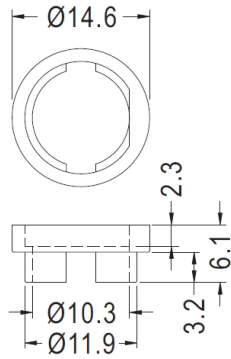

PART NO	PACKAGE
BNCZ01	1000

BNC防尘盖 BNC Connector Cover



- ◆ MATERIAL : PE
- ◆ COLOR : NATURAL
- ◆ UNIT: mm

用途: BNC防尘盖, 用于BNC接头防尘与保护用。

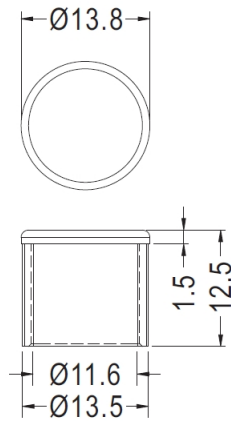

PART NO	PACKAGE
BNCZ02	1000

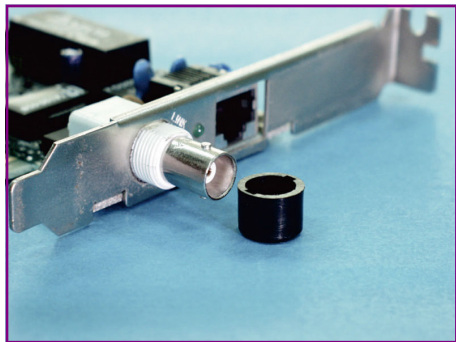

- ◆ MATERIAL : PE
- ◆ COLOR : BLACK/GRAY
- ◆ UNIT: mm

用途: BNC防尘盖, 用于BNC接头防尘与保护用。

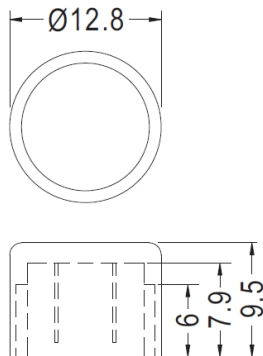

PART NO	PACKAGE
BNCZ03	1000

SATA防尘盖 SATA Cover

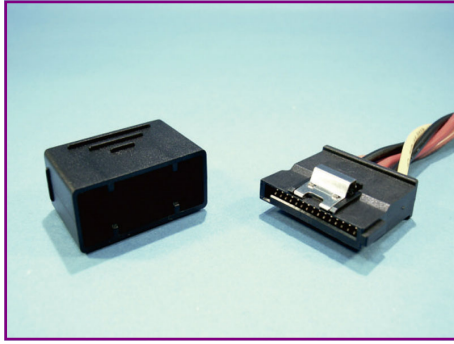

- ◆ MATERIAL : PC+ABS (UL)
- ◆ FLAME CLASS : 94V-2/94V-0
- ◆ COLOR : BLACK
- ◆ UNIT: mm

用途: SATA防尘盖, 用于SATA端子之防尘盖。

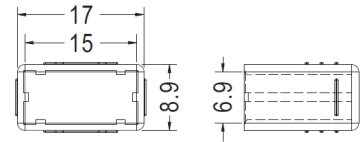
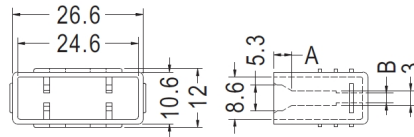
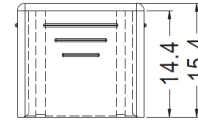
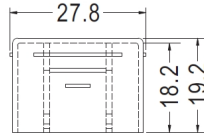

PART NO	A	B	PACKAGE
SATA-1	3.7	2.0	500
SATA-2	9.7	-	500

PART NO	PACKAGE
SATA-3	1000

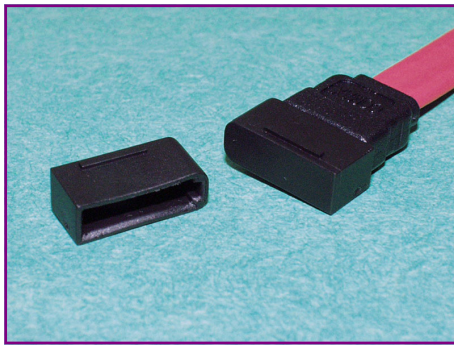

- ◆ MATERIAL : PE
- ◆ COLOR : BLACK
- ◆ UNIT: mm

用途: SATA防尘盖, 用于SATA端子之防尘盖。

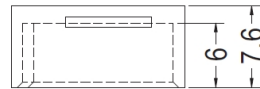
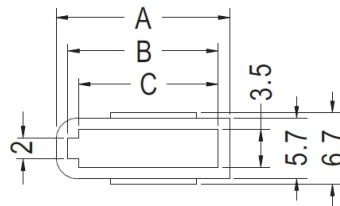

PART NO	A	B	C	PACKAGE
SATA-4	26.4	24.2	23.2	1000
SATA-5	16.2	14.0	13.0	1000

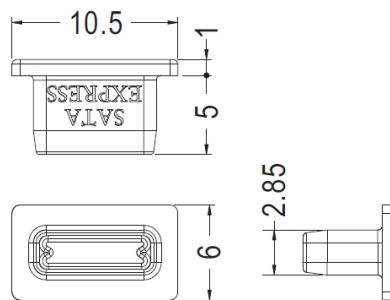

PART NO	PACKAGE
SATA-9	1000

SATA防尘盖 SATA Cover

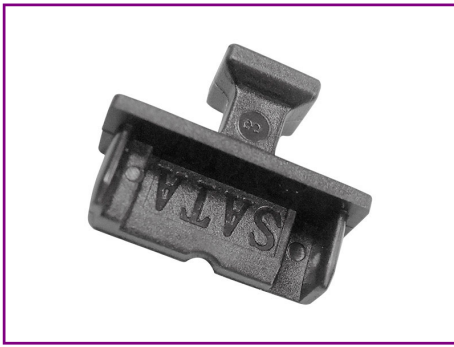

- ◆ MATERIAL : PE
- ◆ COLOR : BLACK
- ◆ UNIT: mm

用途：SATA防尘盖，用于SATA端子的防尘。

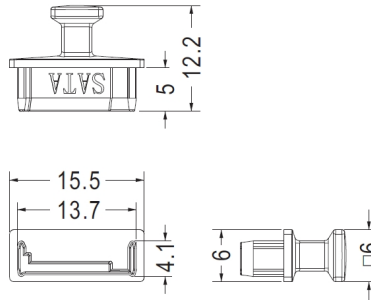

PART NO	PACKAGE
SATA-6	1000

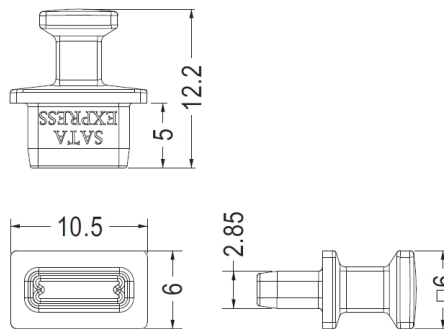

PART NO	PACKAGE
SATA-8	1000

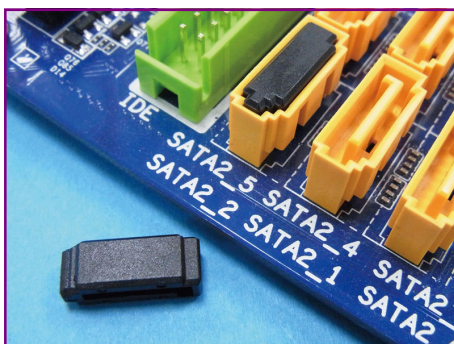

- ◆ MATERIAL : PE
- ◆ COLOR : BLACK
- ◆ UNIT: mm

用途：SATA防尘盖，用于多余不使用的SATA端子之遮蔽，避免误用。

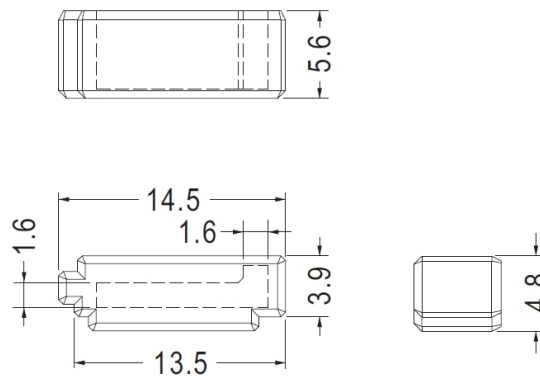

PART NO	PACKAGE
SATA-7	1000

SATA防尘盖 SATA Cable Plug Cover



- ◆ MATERIAL : PC+ABS (UL)
- ◆ FLAME CLASS : 94V-0
- ◆ COLOR : BLACK
- ◆ UNIT: mm

用途: SATA防尘盖, 用于SATA端子之防尘盖。

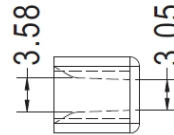
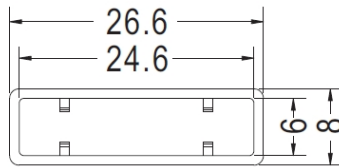
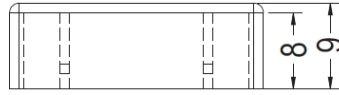

PART NO	PACKAGE
SATA-10	500

ESATA护盖 ESATA Cover

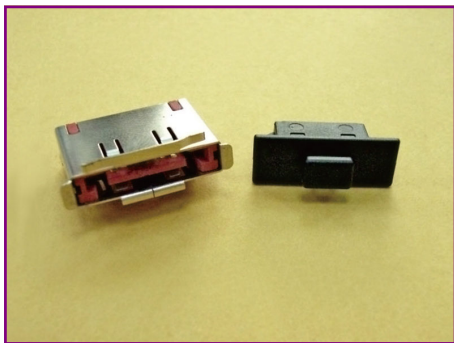

- ◆ MATERIAL : ABS (UL)
- ◆ FLAME CLASS : 94HB
- ◆ COLOR : BLACK
- ◆ UNIT: mm

用途: ESATA护盖, 于ESATA上保护插头, 防氧化。

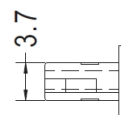
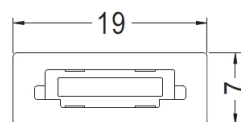
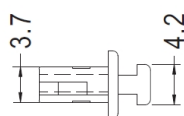
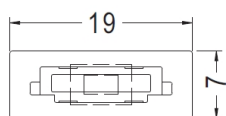
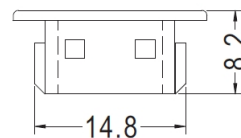
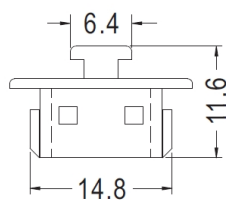

PART NO	PACKAGE
ESATA-1C	1000

PART NO	PACKAGE
ESATA-2C	1000

DP端子防尘盖 DP Connector Cover

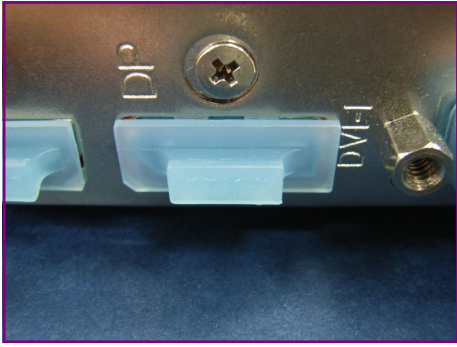

用途：DP端子防尘盖，用作数位D.P端子的防尘盖、美观。

- ◆ MATERIAL : PE
- ◆ COLOR : NATURAL/TRANSPARENT BLUE
- ◆ UNIT: mm

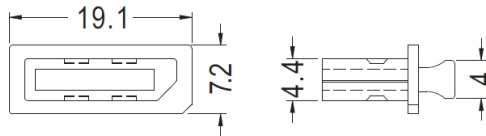
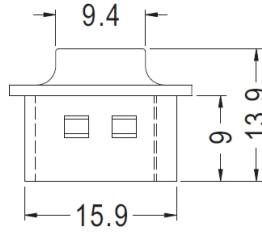

PART NO	PACKAGE
GFR-40	1000

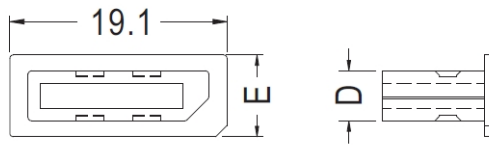
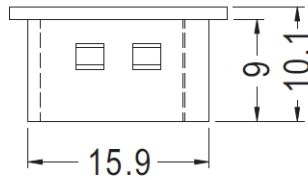

PART NO	D	E	PACKAGE
GFR-41	4.4	7.2	1000
GFR-76	4.5	7.4	1000

DP端子防尘盖 DP Connector Cover



- ◆ MATERIAL : PE
- ◆ COLOR : BLACK
- ◆ UNIT: mm

用途：DP端子防尘盖，使多余或无功能的Display Port(DP端子)遮蔽，避免使用者误插。

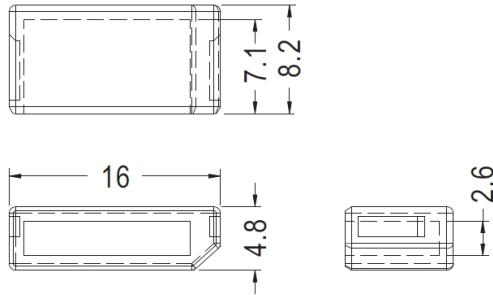

PART NO	PACKAGE
GFR-42	1000

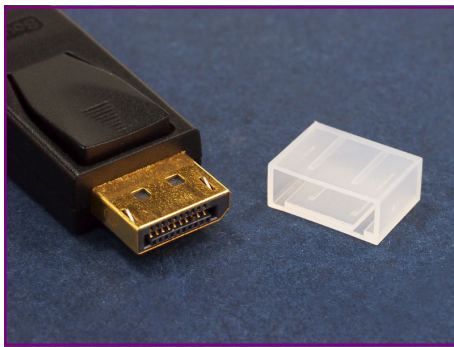

- ◆ MATERIAL : PE
- ◆ COLOR : NATURAL
- ◆ UNIT: mm

用途：DP端子防尘盖，用于Display Port(DP端子)之防尘与保护。

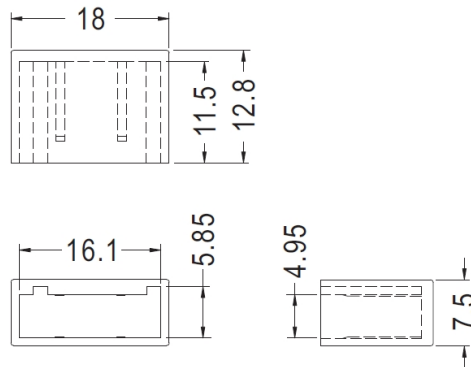

PART NO	PACKAGE
GFR-71	1000

Mini D.P数位端子防尘盖 DP Connector Cover

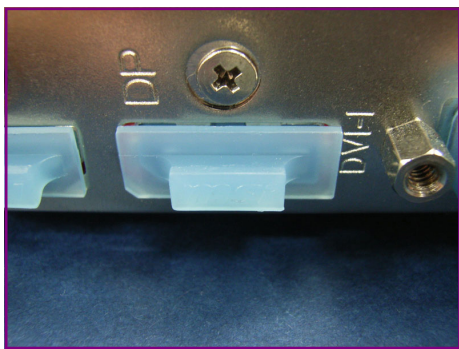

用途：Mini D.P数位端子防尘盖，用于Mini D.P数位端子之防尘盖、美观。

- ◆ MATERIAL : PE
- ◆ COLOR : NATURAL/TRANSPARENT BLUE
- ◆ UNIT: mm

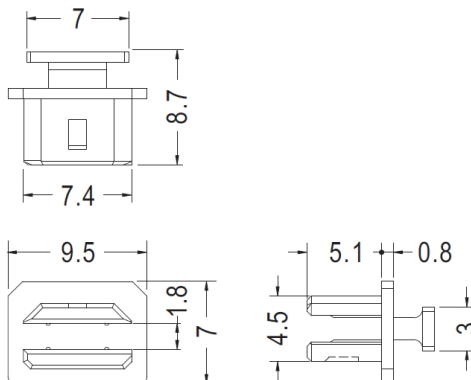

PART NO	PACKAGE
GFR-53	2000

D.Type防尘盖 D.Type Connector Cover

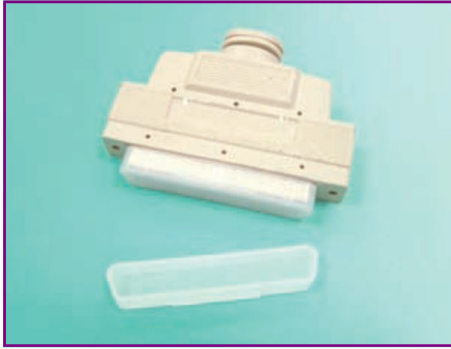

用途：D.Type防尘盖，用于D.Type连接器之防锈、防尘与保护。

- ◆ MATERIAL : PE
- ◆ COLOR : BLACK/NATURAL/COMPUTER
- ◆ UNIT: mm

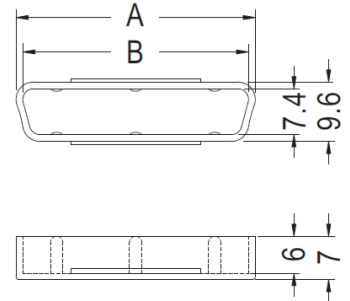
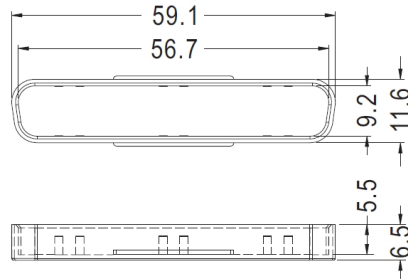

PART NO	PACKAGE
D.TYPE-1	250

PART NO	D	E	PACKAGE
D.TYPE-12	50.2	48.0	500
D.TYPE-14	38.7	36.5	500

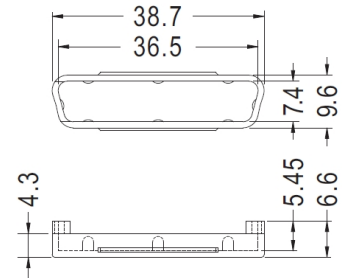
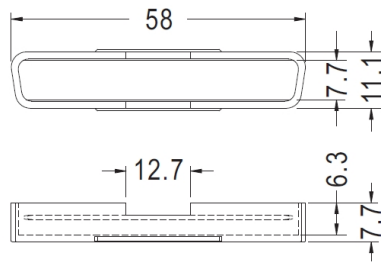

PART NO	PACKAGE
D.TYPE-11	250

PART NO	PACKAGE
D.TYPE-13	500

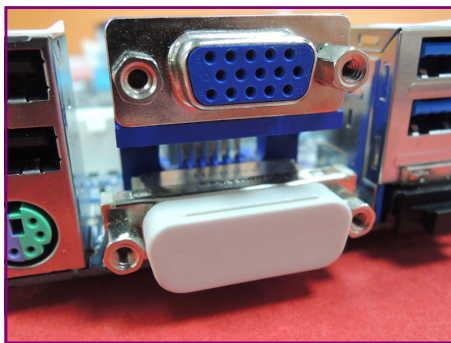

用途：D.Type防尘盖，用于D.Type连接器之防锈、防尘与保护。

- ◆ MATERIAL : PP (UL)
- ◆ FLAME CLASS :94HB
- ◆ COLOR : NATURAL/BLACK/GRAY
- ◆ UNIT: mm

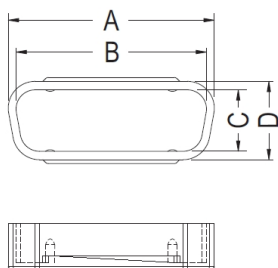

PART NO	A	B	C	D	PACKAGE
D.TYPE-2	18.5	16.5	7.8	10.2	1000
D.TYPE-3	20.0	18.0	9.4	11.8	1000
D.TYPE-4	26.8	24.8	7.8	10.2	500
D.TYPE-5	28.2	26.4	9.4	11.8	500
D.TYPE-6	40.6	38.6	7.8	10.2	500
D.TYPE-7	42.0	40.0	9.4	11.8	500

D.Type防尘盖 D.Type Connector Cover



- ◆ MATERIAL : PP (UL)
- ◆ FLAME CLASS :94HB
- ◆ COLOR : BLACK/TRANSPARENT
- ◆ UNIT: mm

用途: D.Type防尘盖, 用于D.Type连接器之防锈、防尘与保护。

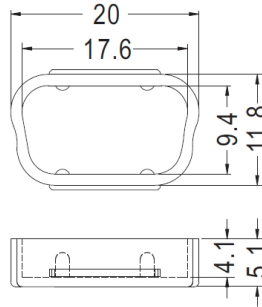

PART NO	PACKAGE
D.TYPE-8	1000

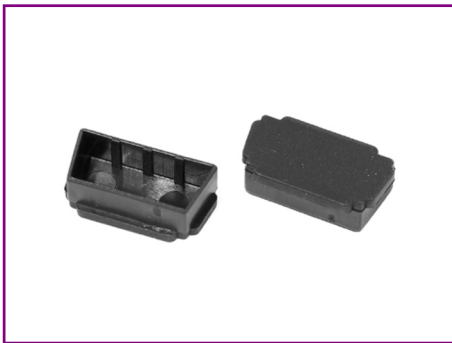

- ◆ MATERIAL : NYLON 66 (UL)
- ◆ FLAME CLASS :94V-2/94V-0
- ◆ COLOR : BLACK/NATURAL
- ◆ UNIT: mm

用途: D.Type防尘盖, 用于D.Type连接器之防锈、防尘与保护。

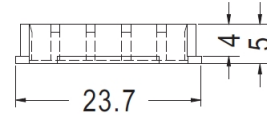
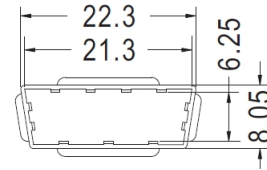
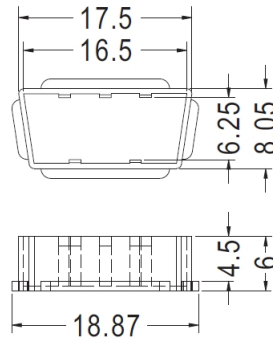

PART NO	PACKAGE
D.TYPE-9	1000

PART NO	PACKAGE
D.TYPE-10	1000

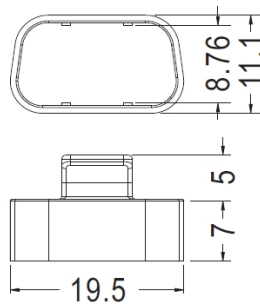

Color: Black/Gray

PART NO	PACKAGE
D.TYPE-15	500

DVI防尘盖 DVI Connector Cover



- ◆ MATERIAL : PE
- ◆ COLOR : BLACK/NATURAL
- ◆ UNIT: mm

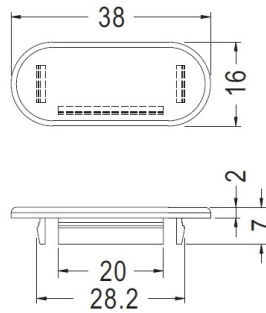

用途：DVI防尘盖，可将多余的机壳出线口遮盖，装配容易。

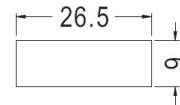

MOUNTING HOLE THICKNESS 0.6~1.2

PART NO	PACKAGE
DVI-1	500



- ◆ MATERIAL : PP (UL)
- ◆ FLAME CLASS :94HB
- ◆ COLOR : NATURAL/BLACK
- ◆ UNIT: mm

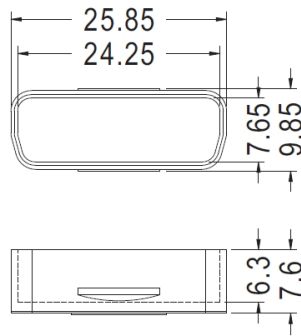

- ◆ MATERIAL : TPE
- ◆ COLOR : NATURAL/BLACK
- ◆ UNIT: mm

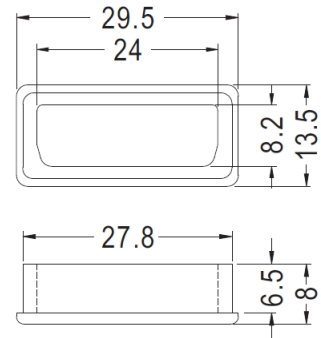

PART NO	PACKAGE
DVICK11	500

PART NO	PACKAGE
DVICK13	500

VGA防尘盖 VGA Connector Cover

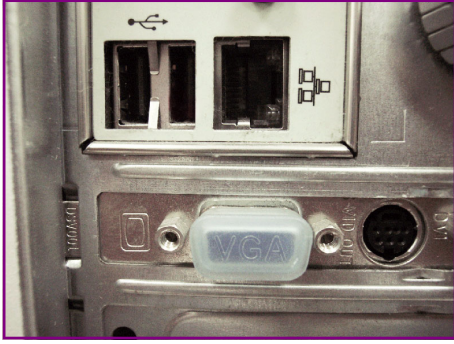

- ◆ MATERIAL : PP (UL)
- ◆ FLAME CLASS :94HB
- ◆ COLOR : NATURAL/TRANSPARENT
- ◆ UNIT: mm

用途：VGA防尘盖，VGA端子之防尘盖、美观。

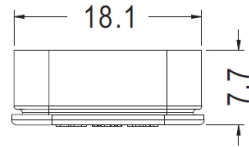
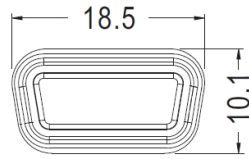

PART NO	PACKAGE
VGA-1	500

IDE Connector防尘盖 IDE Connector Cover

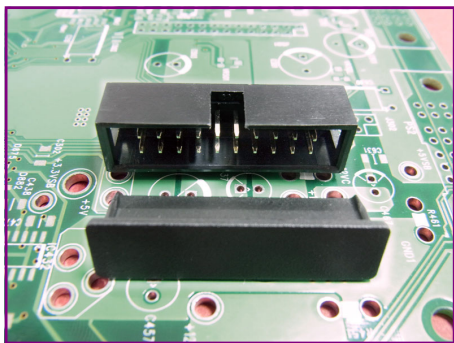

- ◆ MATERIAL : PE
- ◆ COLOR : BLACK
- ◆ UNIT: mm

用途: IDE Connector防尘盖, 用于IDE Connector防尘与保护。

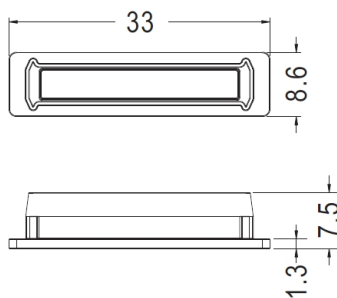

PART NO	PACKAGE
GFR-39	500

PC端子防尘盖 Connector Cover

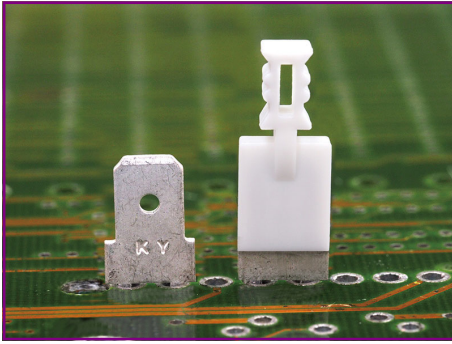

- ◆ MATERIAL : NYLON 66 (UL)
- ◆ FLAME CLASS :94V-2/94V-0
- ◆ COLOR : NATURAL/WHITE/BLACK
- ◆ UNIT: mm

用途：PC端子防尘盖，用于PC端子PCBNT020防尘盖。

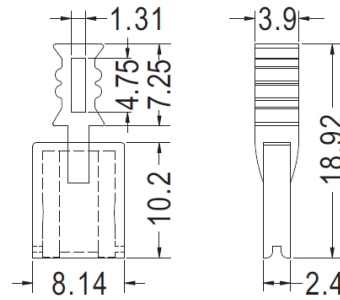

PART NO	PACKAGE
GFR-69	1000



- ◆ MATERIAL : PE
- ◆ COLOR : NATURAL/BLACK
- ◆ UNIT: mm

用途：PC端子防尘盖，用于PC端子防尘盖。

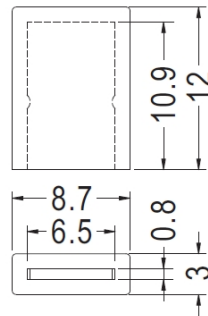

PART NO	PACKAGE
GFR-77	1000

1394端子防尘盖 1394 Connector Cover

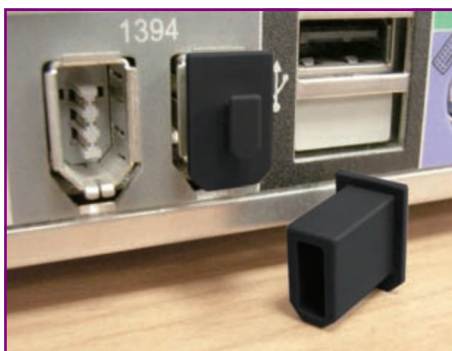

- ◆ MATERIAL : PE
- ◆ COLOR : BLACK
- ◆ UNIT: mm

用途：1394端子防尘盖，用于1394接头
防尘与保护。

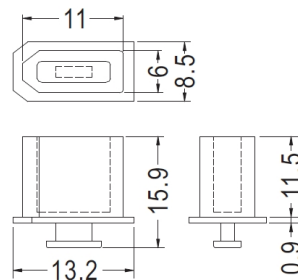
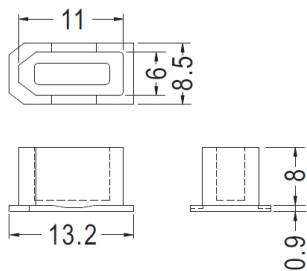

PART NO	PACKAGE
1394-001	1000

PART NO	PACKAGE
1394-005	1000



- ◆ MATERIAL : PP (UL)
- ◆ FLAME CLASS :94HB
- ◆ COLOR : GRAY
- ◆ UNIT: mm

用途：1394端子防尘盖，用于1394接头
防尘与保护。

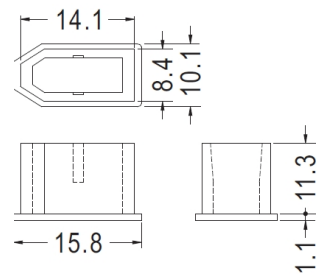
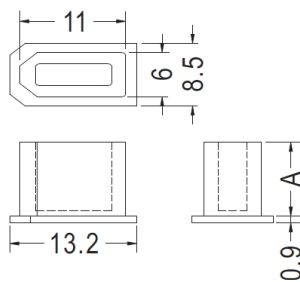

PART NO	PACKAGE
1394-002	1000

PART NO	A	PACKAGE
1394-003	10.0	1000
1394-004	11.0	1000



- ◆ MATERIAL : PE
- ◆ COLOR : BLACK/COMPUTER
- ◆ UNIT: mm

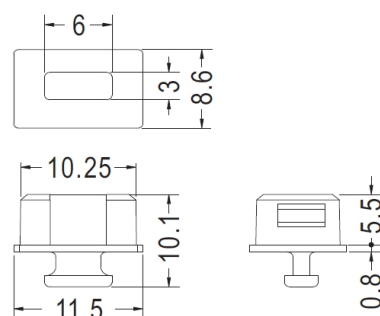

PART NO	PACKAGE
1394-006	1000

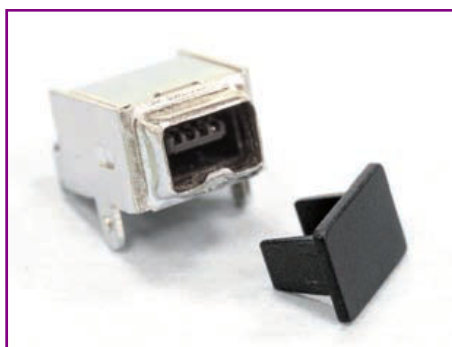

- ◆ MATERIAL : ABS (UL)
- ◆ FLAME CLASS :94HB
- ◆ COLOR : BLACK
- ◆ UNIT: mm

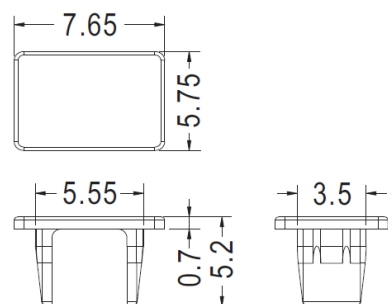

PART NO	PACKAGE
1394-007	1000

端子防尘盖 Connector Cover



- ◆ MATERIAL : TPE
- ◆ COLOR : BLACK
- ◆ UNIT: mm

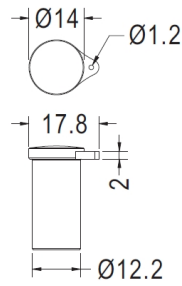

PART NO	PACKAGE
DZGR-09	1000

用途：端子防尘盖，做为端子之防尘与保护。

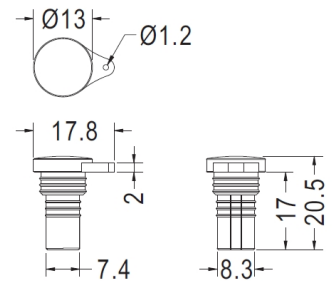

PART NO	PACKAGE
DZGR-10	1000

Ø3.5 mm音源线防尘盖 Dust Cover



- ◆ MATERIAL : PP
- ◆ COLOR : NATURAL
- ◆ UNIT: mm

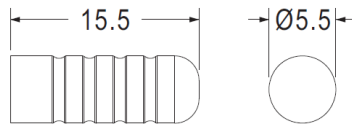

用途：用于Ø3.5 mm音源线之防尘与保护。

PART NO	PACKAGE
EARC-3.5	2000

零件盖 Connector Cover

用途：零件盖，用于零件之防尘与保护。

- ◆ MATERIAL : ABS (UL)
- ◆ FLAME CLASS :94HB
- ◆ COLOR : BLACK
- ◆ UNIT: mm

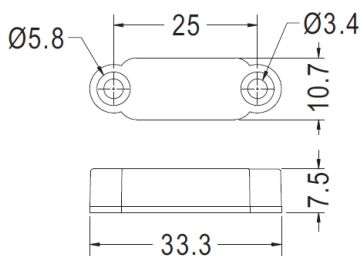

PART NO	PACKAGE
NVE-2	1000

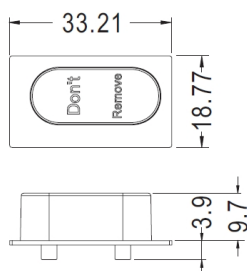

PART NO	PACKAGE
NVE-3	1000

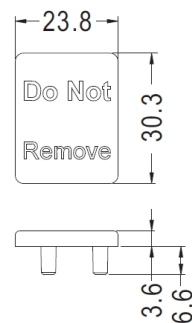
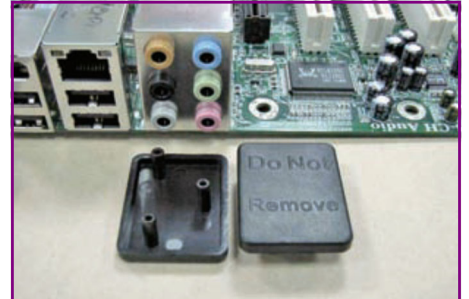

PART NO	PACKAGE
NVE-4	1000

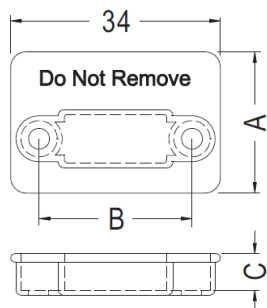

PART NO	A	B	C	PACKAGE
NVE-5	21.5	25.0	5.8	1000
NVE-6	23.0	24.8	6.0	1000

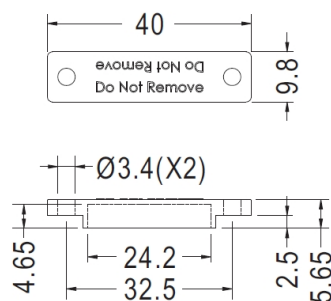

PART NO	PACKAGE
NVE-7	500

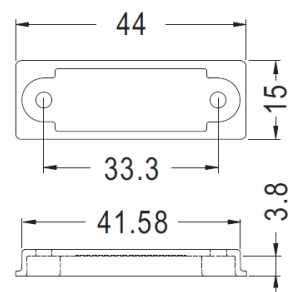

PART NO	PACKAGE
NVE-8	1000

电源盖 Power Supply Cap

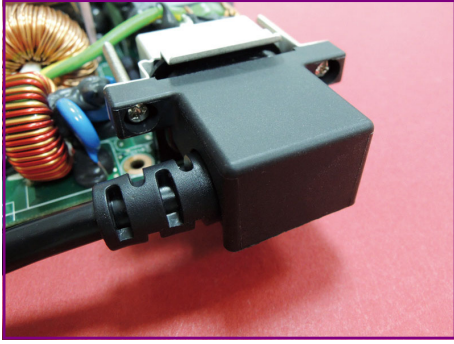

- ◆ MATERIAL : NYLON 66 (UL)
- ◆ FLAME CLASS :94V-2/94V-0
- ◆ COLOR : BLACK/NATURAL
- ◆ UNIT: mm

用途：电源盖，用于电源线之固定与保护，避免脱落。

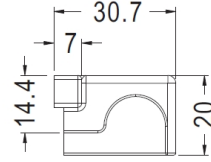
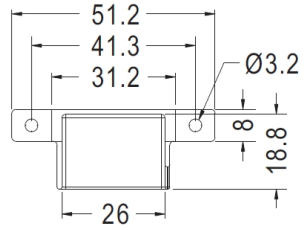

PART NO	PACKAGE
VA-1	500

机板电源保护盖 Power Connector Cover

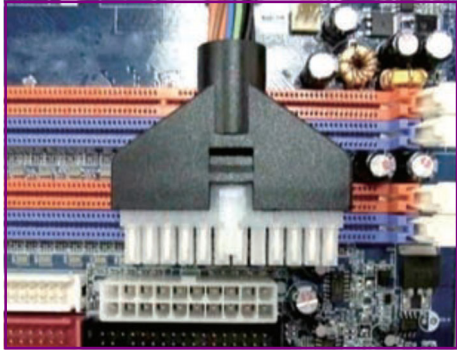

- ◆ MATERIAL : PE
- ◆ COLOR : BLACK
- ◆ UNIT : mm

用途：机板电源保护盖，保护主板电源端子，防尘与美观。

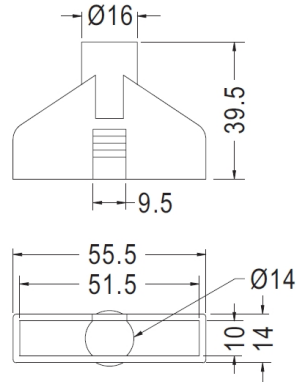

PART NO	PACKAGE
S ATK-1	250

连接器座 Connector Holder

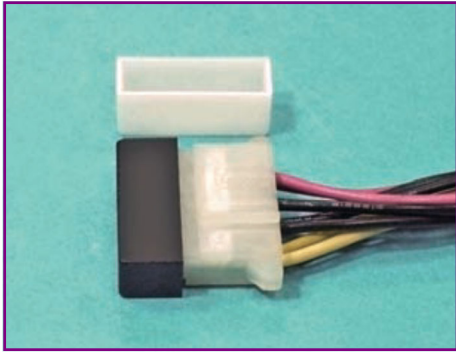

- ◆ MATERIAL : NYLON 66 (UL)
- ◆ FLAME CLASS :94V-2/94V-0
- ◆ COLOR : BLACK/NATURAL
- ◆ UNIT: mm

用途：连接器座，用于连接器防尘与保护用。

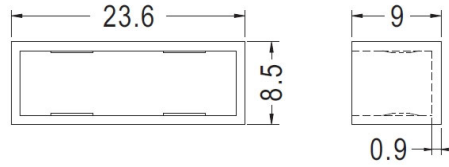

PART NO	PACKAGE
VFCH01	500

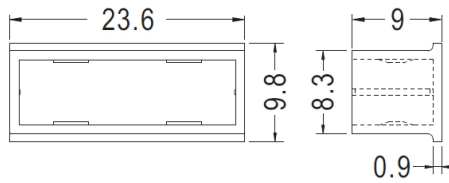

PART NO	PACKAGE
VFCH02	500

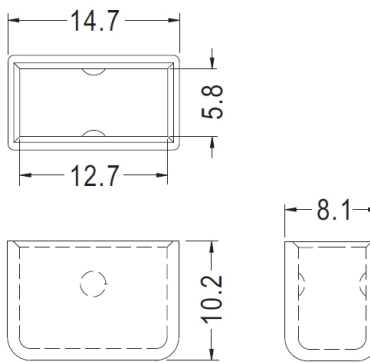
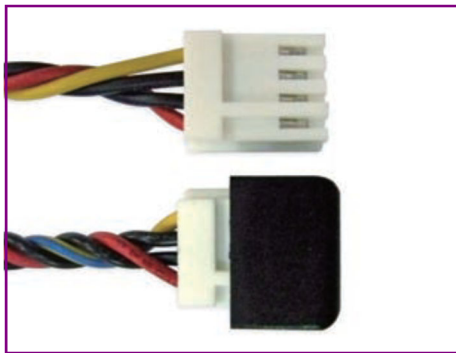

PART NO	PACKAGE
VFCH03	1000

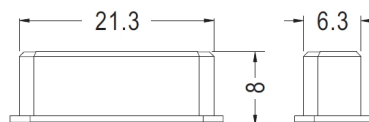
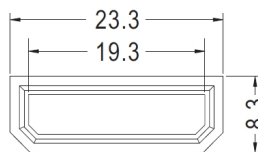

PART NO	PACKAGE
VFCH04	500

连接器座 Connector Holder

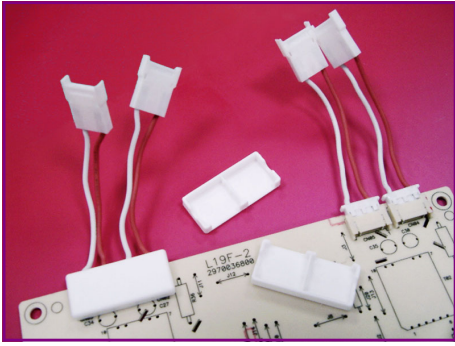

- ◆ MATERIAL : NYLON 66 (UL)
- ◆ FLAME CLASS :94V-2/94V-0
- ◆ COLOR : BLACK/NATURAL
- ◆ UNIT: mm

用途：连接器座，用于连接器防尘与保护用。

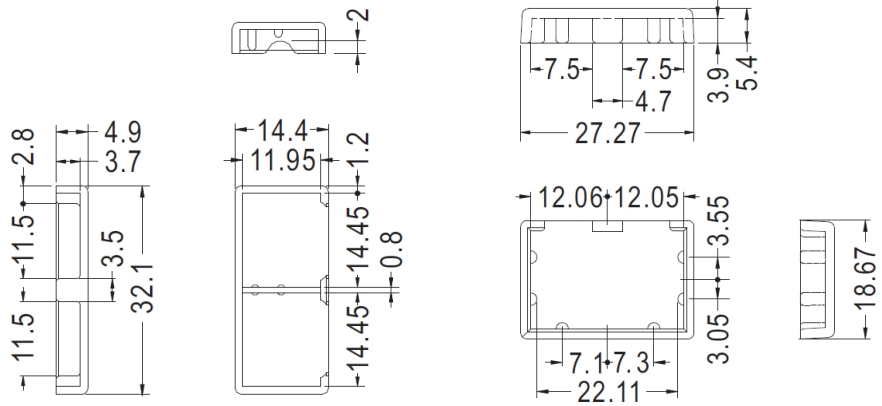

PART NO	PACKAGE
VFCH05	500

PART NO	PACKAGE
VFCH06	500

PCMIC卡保护盖 PCMIC Card Socket Cover



- ◆ MATERIAL : ABS(UL)
- ◆ FLAME CLASS :94HB
- ◆ COLOR : BLACK/WHITE
- ◆ UNIT: mm

用途：PCMIC卡保护盖，用于PCMIC卡保护用。

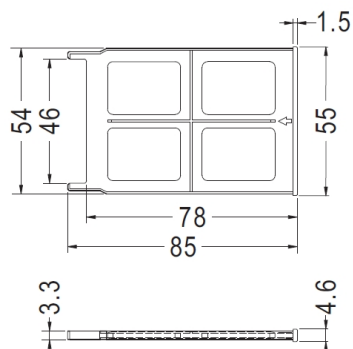

PART NO	PACKAGE
PCMIC01	100

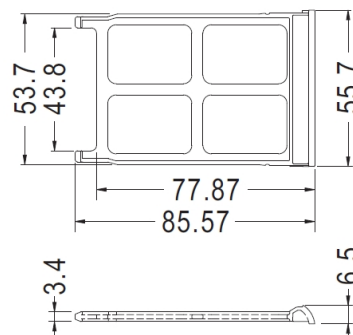

PART NO	PACKAGE
PCMIC02	100

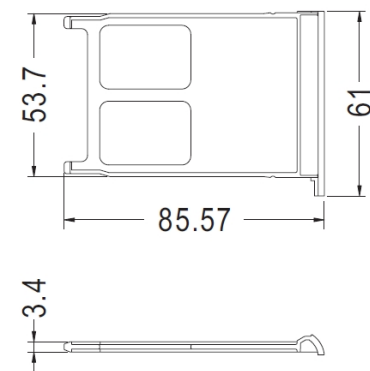

PART NO	PACKAGE
PCMIC03	100

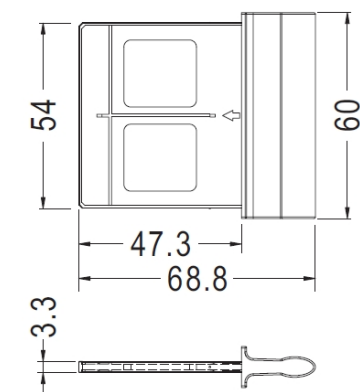

PART NO	PACKAGE
PCMIC04	100

面板 CARD BEZEL



- ◆ MATERIAL : PC+ABS (UL) 用途：面板，用于IC卡读卡器之面板。
- ◆ FLAME CLASS :94V-0
- ◆ COLOR : BLACK
- ◆ UNIT: mm

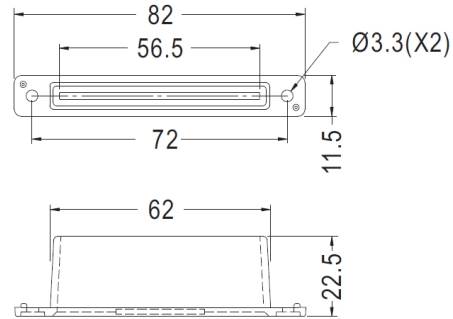

PART NO	PACKAGE
KB-1	100

DDR防尘盖 DDR COVER



- ◆ MATERIAL : PC+ABS(UL)
- ◆ FLAME CLASS :94V-0
- ◆ COLOR : BLACK
- ◆ UNIT: mm

用途：DDR防尘盖，用于DDR内存之防尘。

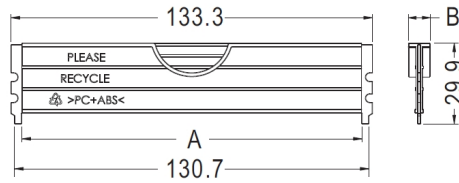

PART NO	A	B	FOR	PACKAGE
DDR-1	125.5	8.0	DDR3	50
DDR-2	125.3	8.0	DDR4	50
DDR-3	125.3	7.5	DDR4	50

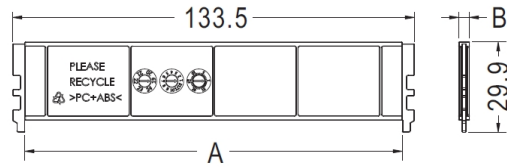

PART NO	A	B	FOR	PACKAGE
DDR-4	125.5	3.65	DDR5	80

D-SUB保护盖 CARD BEZEL



- ◆ MATERIAL : PC+ABS (UL)
- ◆ FLAME CLASS :94V-0
- ◆ COLOR : BLACK
- ◆ UNIT: mm

用途: D-SUB保护盖, 用于D-SUB之保护用。

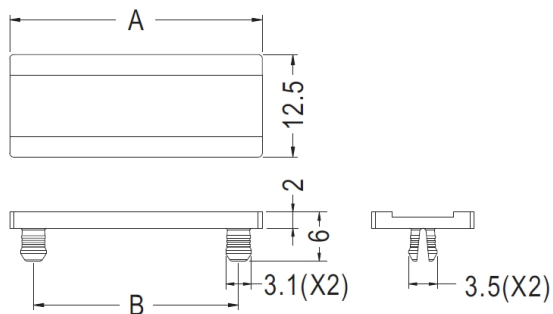

PART NO	A	B	PACKAGE
D-SUB-3012	30.8	25.0	500
D-SUB-5312	53.0	47.0	250
D-SUB-6912	69.3	63.5	250

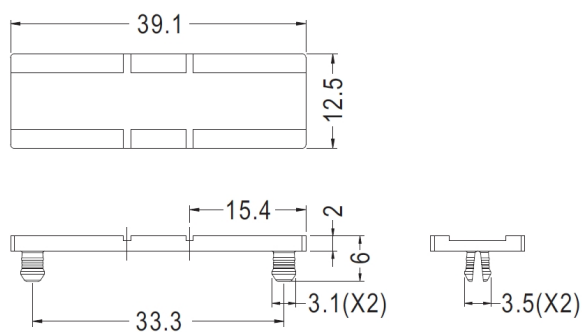

PART NO	PACKAGE
D-SUB-3912	500

高压防尘盖 PLASTIC COVER

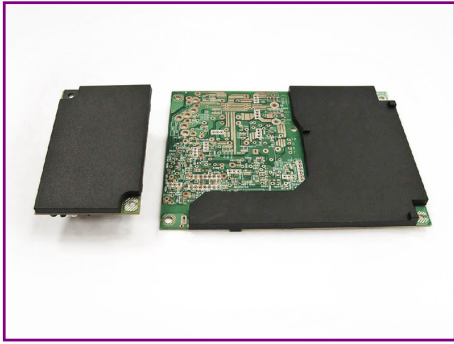

- ◆ MATERIAL : NYLON 66(UL)
- ◆ FLAME CLASS :94V-0/94V-2
- ◆ COLOR : BLACK/NATURAL
- ◆ UNIT: mm

用途： 高压防尘盖，用于开关电源高压部分，防止蟑螂入侵，避免造成短路可作为绝缘及防尘、保护用。(尺寸可依客户PC板设计)

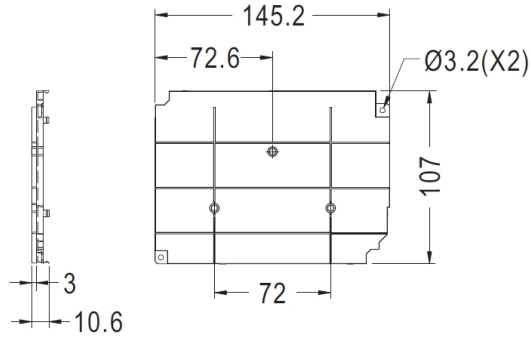

PART NO	PACKAGE
GF-1	500

SD卡保护盖 SD CARD SOCKET COVER



- ◆ MATERIAL : ABS (UL)
- ◆ FLAME CLASS :94HB
- ◆ COLOR : BLACK
- ◆ UNIT: mm

用途：SD卡保护盖，用于SD卡保护用。

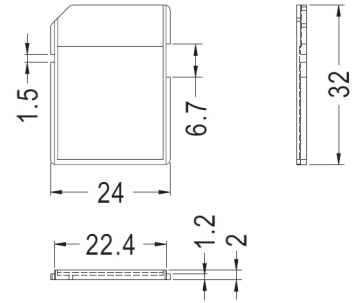
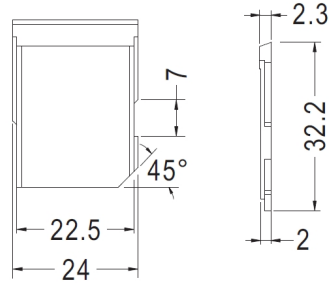

PART NO	PACKAGE
SDA	500

PART NO	PACKAGE
SDB	500

Micro SD卡保护盖 Micro SD CARD SOCKET COVER



- ◆ MATERIAL : PC+ABS (UL)
- ◆ FLAME CLASS :94V-2
- ◆ COLOR : BLACK
- ◆ UNIT: mm

用途：Micro SD卡保护盖，用于Micro SD卡保护用。

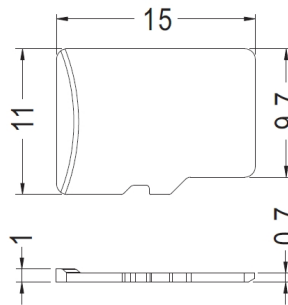

PART NO	PACKAGE
MIC-SD1	1000

SIM卡保护盖 SIM CARD SOCKET COVER



- ◆ MATERIAL : PC
- ◆ COLOR : BLACK
- ◆ UNIT: mm

用途：SIM卡保护盖，用于SIM卡之防尘与保护。

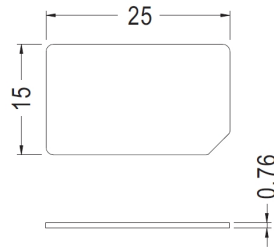

PART NO	PACKAGE
SIM-1	1000

防水帽盖 WATERPOOFCAP



- ◆ MATERIAL : TPV
- ◆ COLOR : BLACK
- ◆ UNIT: mm

用途：防水帽盖，用于零件之防水盖。

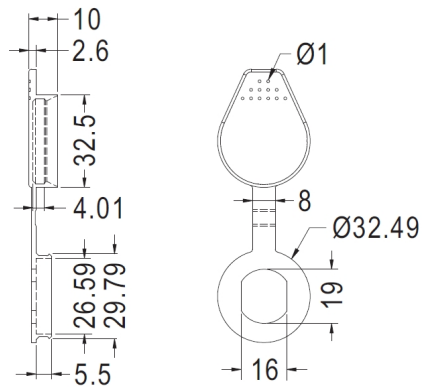

PART NO	PACKAGE
EF-1	100

帽盖连接带 CAP WITH CONNECTING TIE

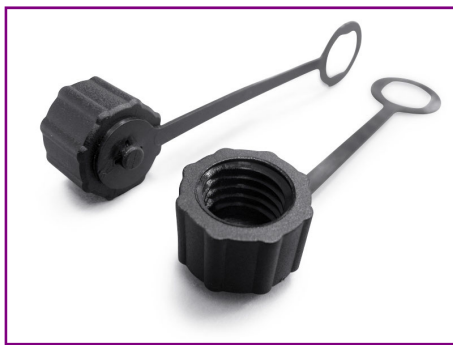

- ◆ MATERIAL : NYLON 66 (UL)/PE
- ◆ FLAME CLASS :94HB
- ◆ COLOR : BLACK
- ◆ UNIT: mm

用途：帽盖连接带，用于零件接头之防水，中间有连接，避免防尘盖遗失。

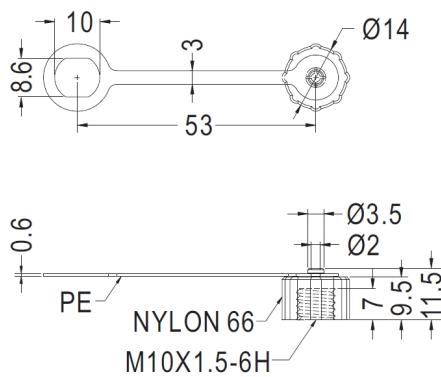

PART NO	PACKAGE
LTSV1	500

防水圈 WATERPROOFRING



- ◆ MATERIAL : TPV
- ◆ COLOR : BLACK
- ◆ UNIT: mm

用途：防水帽盖，用于零件之防水盖。

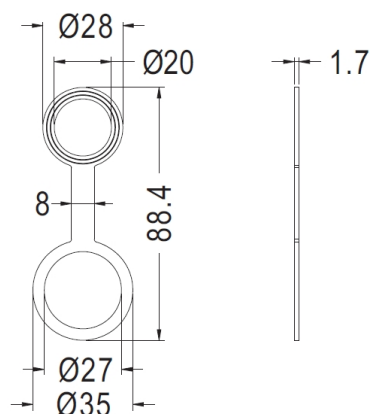

PART NO	PACKAGE
WTR-1	100

电脑风扇护盖 REAR FAN PROTECTIBE COVER



- ◆ MATERIAL : PBT (UL)
- ◆ FLAME CLASS :94V-0
- ◆ COLOR : BLACK
- ◆ UNIT: mm

用途：电脑风扇护盖，用于计算机风扇外框。

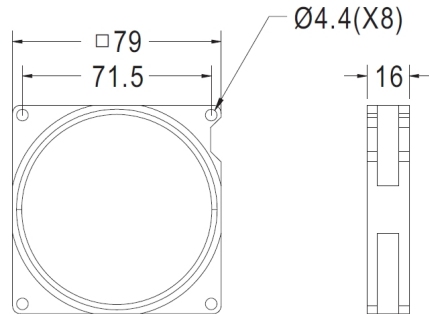

PART NO	PACKAGE
FSH-1	500



- ◆ MATERIAL : PP (UL)
- ◆ FLAME CLASS :94V-0/94V-2
- ◆ COLOR : BLACK
- ◆ UNIT: mm

用途：电脑风扇护盖，用于计算机风扇外框。

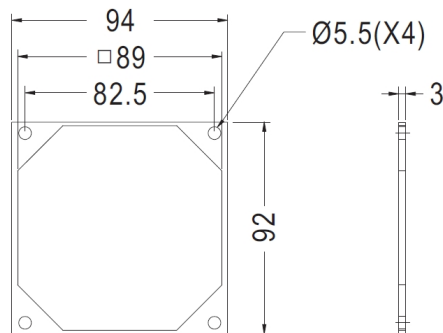

PART NO	PACKAGE
FSH-3	500



- ◆ MATERIAL : PBT (UL)
- ◆ FLAME CLASS :94V-0
- ◆ COLOR : BLACK
- ◆ UNIT: mm

用途：电脑风扇护盖，用于计算机风扇外框。

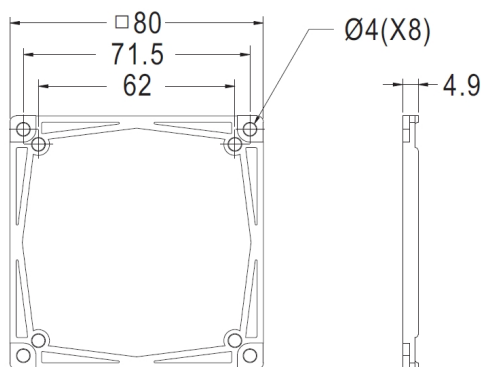

PART NO	PACKAGE
FSH-4	500

电脑风扇护盖 REAR FAN PROTECTIVE COVER

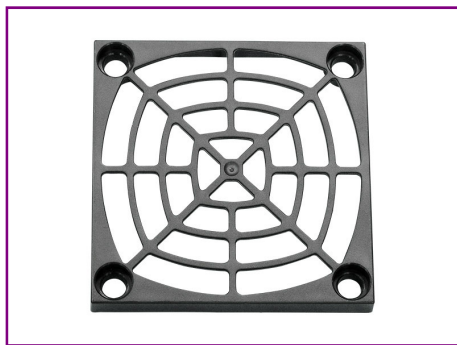

- ◆ MATERIAL : ABS (UL)
- ◆ FLAME CLASS :94V-0
- ◆ COLOR : BLACK
- ◆ UNIT: mm

用途：电脑风扇护盖，用于计算机风扇外框。

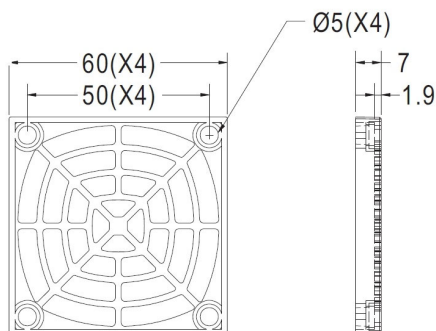

PART NO	PACKAGE
FSH-5	100

电脑风扇防尘座 ANTI-DUST FAN GUARD



- ◆ MATERIAL : PC+ABS (UL)
- ◆ FLAME CLASS :94V-0
- ◆ COLOR : BLACK
- ◆ UNIT: mm

用途：电脑风扇防尘座，用于计算机或仪器风扇之防尘，避免灰尘进入机器内。

此产品为套件，以下三个零件为一套产品

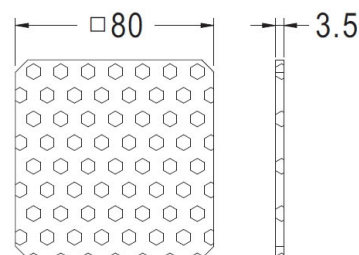
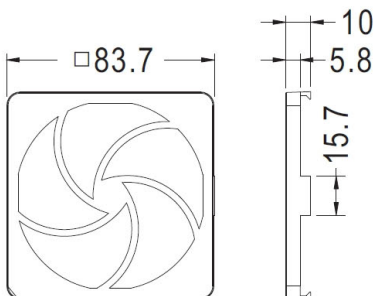
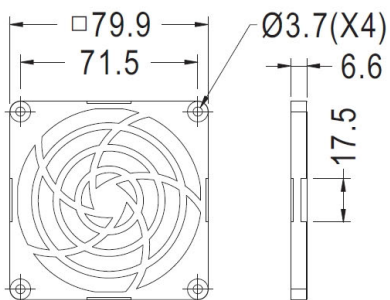

PART NO	PACKAGE
FCZ-1	50

电脑风扇框护垫 FRAME PAD



- ◆ MATERIAL : SILICON RUBBER 用途：电脑风扇框护垫，用于计算机风扇外框的防震，降低噪音。
- ◆ COLOR : BLACK
- ◆ UNIT: mm

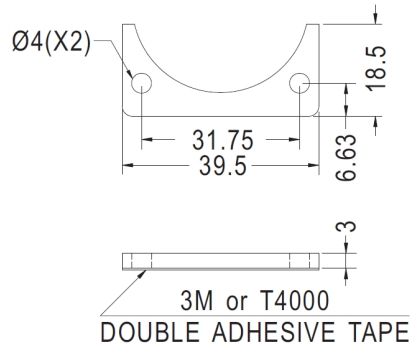

PART NO	PACKAGE
FSG-1	200

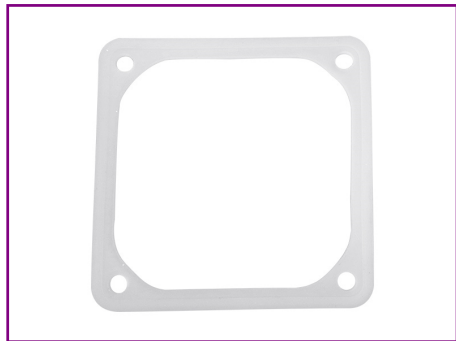

用途：电脑风扇框护垫，用于计算机风扇外框的防震，降低噪音

- ◆ MATERIAL : SILICON RUBBER
- ◆ COLOR : BLACK/TRANSPARENT
- ◆ UNIT: mm

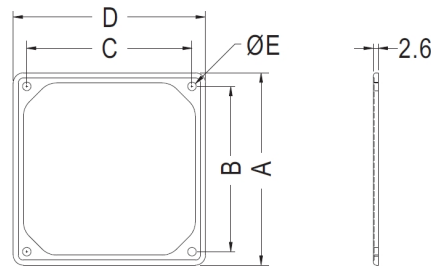

PART NO	A	B	C	D	E	PACKAGE
FSG-2	94.8	81.5	81.5	94.8	4.2	50
FSG-3	122.7	104.8	104.8	122.7	4.0	50
FSG-4	61.4	49.4	49.4	61.4	4.0	100

电脑风扇支架 REAR FAN PROTECTIVE COVER



- ◆ MATERIAL : TPE (UL)
- ◆ FLAME CLASS :94V-0
- ◆ COLOR : BLACK
- ◆ UNIT: mm

用途：电脑风扇支架，用于计算机风扇固定支架。

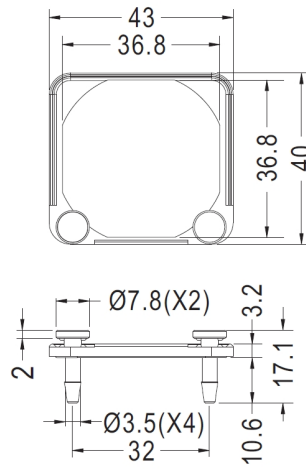

PART NO	PACKAGE
FSH-6	500

开关遮板 SWITCH COVER



- ◆ MATERIAL : ABS (UL)
- ◆ FLAME CLASS : 94HB
- ◆ COLOR : BLACK
- ◆ UNIT: mm

用途：开关遮板，用于开关保护用。

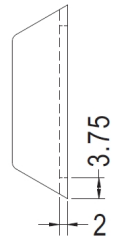
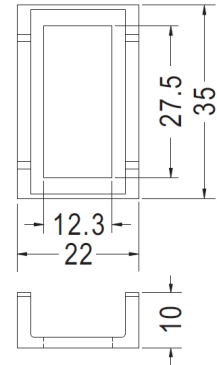
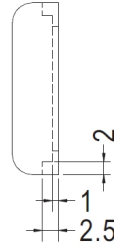
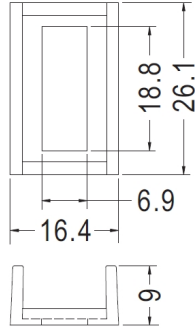

PART NO	PACKAGE
KGZB01	500

PART NO	PACKAGE
KGZB02	500



- ◆ MATERIAL : NYLON 66 (UL)
- ◆ FLAME CLASS : 94V-0/94V-2
- ◆ COLOR : BLACK
- ◆ UNIT: mm

用途：开关遮板，用于开关盖保护用。

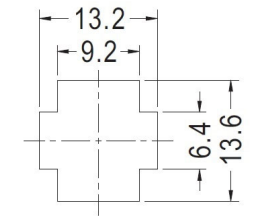
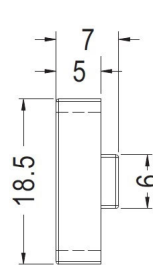
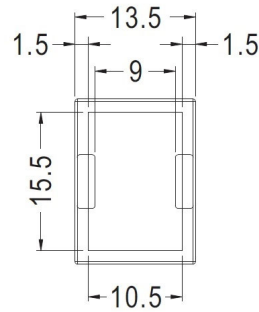

HOLE IN CHASSIS

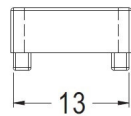

PART NO	PACKAGE
KGZB03	500

光纤晶体座 OPTICAL LENS MOUNT

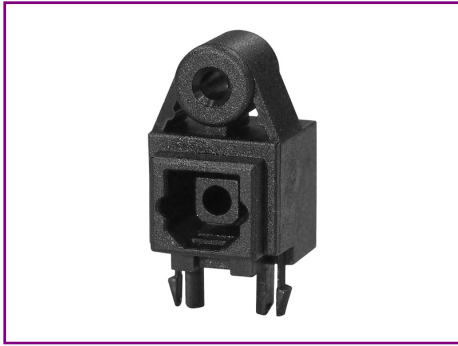

- ◆ MATERIAL : NYLON 66 (UL)
- ◆ FLAME CLASS :94HB
- ◆ COLOR : BLACK
- ◆ UNIT: mm

用途：光纤晶体座，光纤晶体焊于PC板上，高度一致，有定位脚，不倾斜，可与GPH02配合使用。

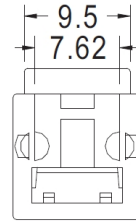
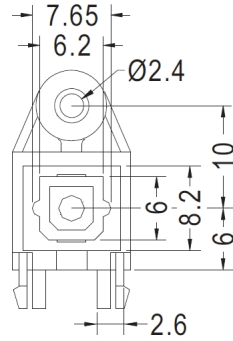

PART NO	PACKAGE
PHT-1	1000

电子电脑塑胶五金零件目录

1.LED间隔柱

2.LED导光柱 LED导光盖 LED遮光罩

3.LED座 LED座套 红外线灯罩 光纤座

4.90°LED灯座 45°LED灯座

5. PC板间隔柱 PC板隔离柱

6. 塑料铜柱 尼龙柱 六角隔离柱 塑胶铜柱 铜柱 导光板隔离柱 圆体间隔柱 PC板固定定座 固定扣 电路板隔离柱 导电隔离柱

7. 排线固定座 自粘式配线固定座 排线固定夹 压线板 电线固定座 扭线固定座 扭式固定环 扎线固定座 电源线固定座 电源线固定座插头固定扣 天线固定座 T8灯管固定座 风扇束线座 光纤固定座

8. PC板端子 接线插片端子 PC板焊接端子 接地片 圆形连接片 弹片 测试针 探针 测试点 保险丝座 保险丝盖 插式电线连接头 闭端端子 弹簧螺纹端子 压线帽 端子台 快速接线夹 跳线

9. 仪表脚垫 插销式脚垫 螺丝固定脚垫 脚垫 抗震脚垫 磁铁脚垫 橡胶脚垫 自粘脚垫 银框脚垫 金框脚垫 橡胶垫圈 橡胶华司 橡胶垫片 硅胶脚垫

10. 塑料螺丝 塑胶螺丝 翼型塑料螺丝 塑料螺帽 塑料螺帽 蝶形螺母 止付螺丝 紧定螺钉 内牙螺丝 螺丝帽盖 手转螺丝 手拧螺丝 滚花螺丝 手转螺母 手拧螺母

11. PC板拉柄 PC板耳把 PC板导槽 电路板导轨 PCB导轨槽 直立式导槽 电路板导轨

12. 晶体管盖 电晶体盖 晶体管垫片 电晶体垫片 晶体管座 电晶体座 T-O3晶体管座 石英晶体垫片 垫圈 华司 垫片 TO-220晶体管座 光电晶体座 电晶体座 IR晶体座 霍尔晶体座 硅胶帽套 功率晶体导热硅片 功率晶体压板 电源固定压条 晶体管固定弹片 五金弹片 电晶体固定弹片 晶体管夹

电子电脑塑胶五金零件目录

13.电容器垫片 垫圈 华司 电容器座 电容器帽套 电容器固定座 电容器盖 电容器护套 压敏护套 硅胶帽套

14.热敏电阻座 电阻保护座 保护电阻器 可变电阻盖

15.陶瓷零件垫片 零件垫片 垫圈 华司 零件垫座 IC座 桥式整流座 跳线座 线圈座 滤波器垫片 绝缘柱 螺丝垫片 滚轮 PC板垫片 球击缓冲垫片 尼龙垫圈 尼龙弹簧垫片 散热陶瓷垫片

16.功率IC盖 桥式整流盖 保护盖 开关盖 硅胶盖 绝缘盖 电池盖 末端套管 软质端子保护套PC端子保护套 喇叭座 拉柄箱扣 线圈固定座 DRAM固定带 十字型插件式固定器 轨道固定器

17.孔塞 扣式孔塞 扣式塞头 DVI防尘盖 螺丝孔孔塞 螺丝塞头 螺纹孔塞

18.电源线扣 电线固定夹 护线环 橡胶圈 护线圈 开口式护线环 橡胶线环 硅胶线环 硅胶护线环 天线护线环 方型护线环 U型护线环 抗震护线环 防震线环 抗震线环用插销 抗震线环用螺丝 硬盘驱动器防震座 透气压力平衡固定头 透气平衡压力固定扣

19.把手 机箱把手 仪器门拉手 纸箱把手 纸箱配件 打包扣 外箱护脚垫 纸箱外箱扣

20.阻尼齿轮 阻尼器 缓冲齿轮

21.电线扎带 电线束线带 固定带 扎线 电源线收线带 珠型扎带 水管座 扎带座 扎带扣 吊勾粘扣带 绑线带

22.USB座护盖 USB端口保护盖 USB端口防尘盖 MICRO USB防尘盖 MINI USB座护盖USB Type-C防尘盖 USB防尘盖 RJ-45防尘盖 RJ-11防尘盖 RJ-12防尘盖 RJ-22防尘盖 电源插头防尘盖 电源插头保护座 电源插头防尘座 电源插头防尘盖 光纤连接器护盖 光纤连接器护套 光纤防尘盖 PC板金手指防尘盖 HDMI防尘盖 Mini数位端子防尘盖 汽车点烟器防尘盖BBU防尘盖 DVI防尘盖 连接器盖 SIM Card Cap防尘盖 SD防尘盖 KVM防尘盖 CF防尘盖 防尘盖 端子盖 S端子盖 平衡端子盖 BNC绝缘座 SATA防尘盖 ESATA护盖 DP端子防尘盖 Mini D.P数位端子防尘盖 D.Type防尘盖 VGA防尘盖 IDE Connector防尘盖 PC端子防尘盖 端子防尘盖 1394端子防尘盖 零件盖 电源盖 机板电源保护盖 连接器座 PCMIC卡保护盖 面板 DDR防尘盖 D-Sub保护盖 高压防尘盖 SD保护盖 Micoro SD卡保护盖 SIM卡保护盖 防水帽盖 帽盖连接带 防水圈 电脑风扇防护盖 电脑风扇防尘座 电脑风扇框护垫 电脑风扇支架 开关遮板 光纤晶体座

电子电脑塑胶五金零件目录

23.插销 铆钉 尼龙铆钉 螺丝铆钉 散热片铆钉 塑料铆钉 电脑风扇铆钉 散热片扣件 弹簧铆钉 螺丝固定座 膨胀螺栓 墙塞 无帽鱼型膨胀管 墙面固定座 石膏板固定座

24.固定扣 门扣开关 机器门扣开关 弹簧固定座 旋转型门扣 门扣碰珠 磁铁门扣

55.工具 线扣工具 进口束线枪 旗型端子工具 国产束线枪 非绝缘端子工具 绝缘端子工具



电子电脑塑胶五金零件目录



1.LED间隔柱



2.LED导光柱



3.LED座



4.90°LED灯座



5.PC板间隔柱



6.塑料铜柱



7.排线固定座



8.PC板端子



9.仪表脚垫



10.塑料螺丝



11.PC板拉柄导槽



12.晶体管盖

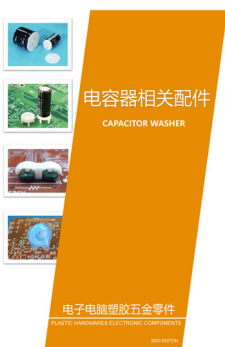

13.电容器垫片



14.热敏电阻座



15.陶瓷零件垫片



16.功率IC盖



电子电脑塑胶五金零件目录



17.孔塞



18.电源线扣



19.机箱把手



20.阻尼齿轮



21.电线扎带



22.USB座护盖



23.尼龙铆钉



24.门扣开关



55.工具

电子电脑塑胶五金零件

PLASTIC HARDWARE & ELECTRONIC COMPONENTS



南京诺金电气有限公司
Nanjing Nojinqing Electric Co., Ltd.

2023.03/17th

选型手册总目录

本公司保留因质量改进、后续开发或生产要求引起的设计更改权力。本产品目录为元件的详细说明，不能做担保依据。使用者有义务审核该元件是否符合应用范围的规定。



微信



QQ

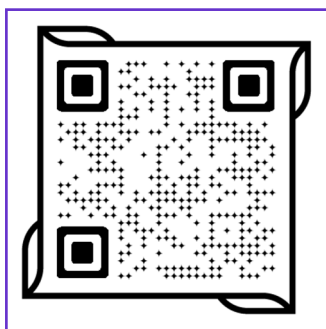

网站

南京诺金电气有限公司

Nanjing Nowking Electric Co., Ltd

- ◆ Tel: 025-85422485 85436028 85437901
- ◆ Wechat/Mobile :13770725488
- ◆ QQ:260678075
- ◆ E-mail: nk@nowking.com
- ◆ Http://www.nowking.com
- ◆ Http://www.kyphe.com