

LED导光柱

LED PIPE

电子电脑塑胶五金零件

PLASTIC HARDWARE& ELECTRONIC COMPONENTS

2023 EDITON

LED导光柱 LED LIGHT PIPE / LED导光盖 LENS CAP

LED遮光罩 LIGHT PIPE MASK

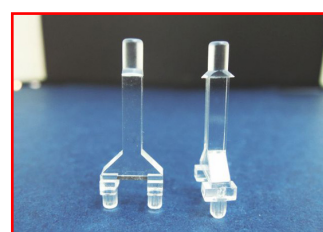
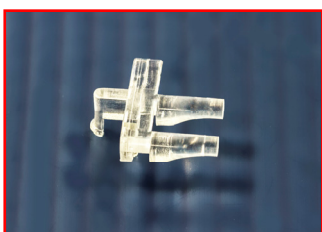
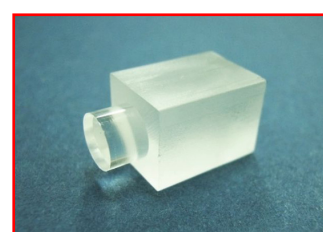
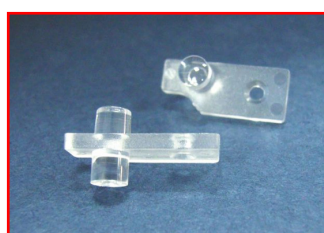
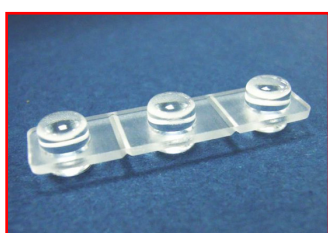
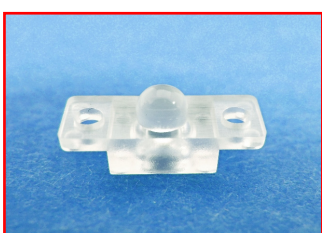
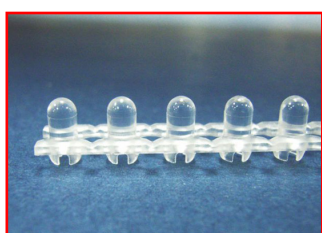
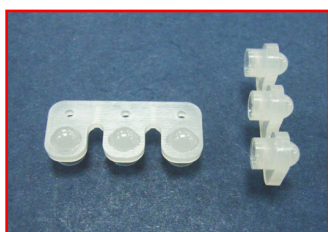
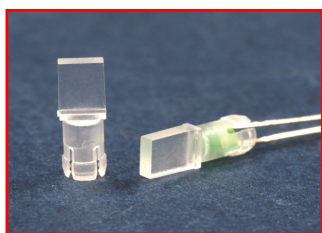

LED导光柱

LED导光柱 LED LIGHT PIPE / LED导光盖 LENS CAP
LED遮光罩 LIGHT PIPE MASK

LED导光柱

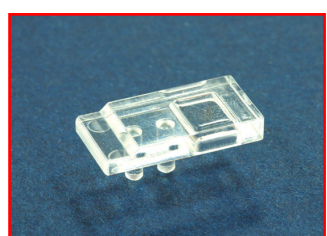
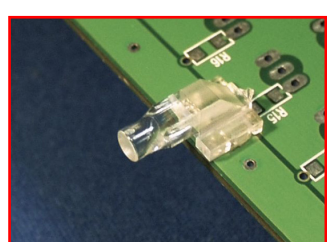
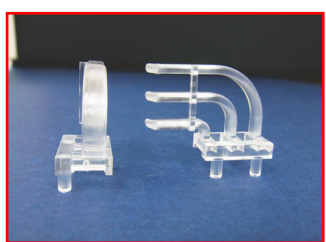
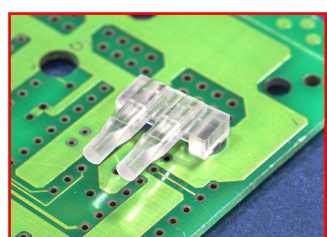
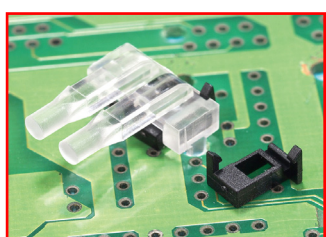
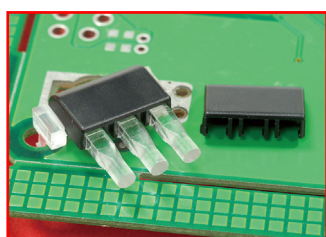
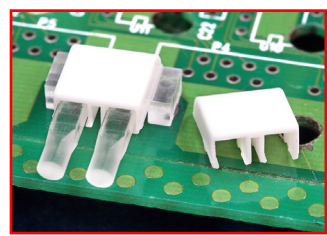
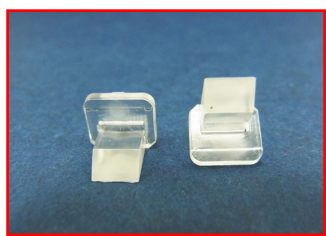
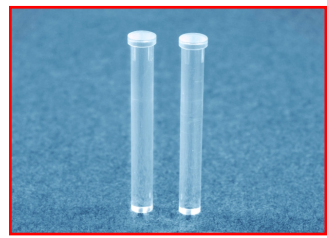
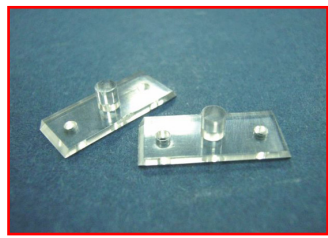
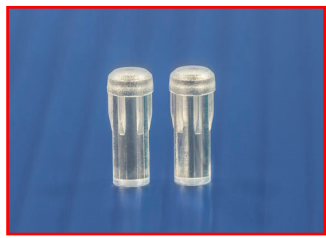
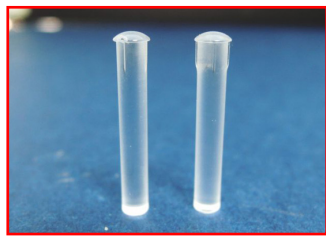
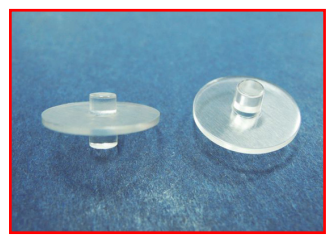

LED导光柱 LED LIGHT PIPE / LED导光盖 LENS CAP

LED遮光罩 LIGHT PIPE MASK

LED导光柱

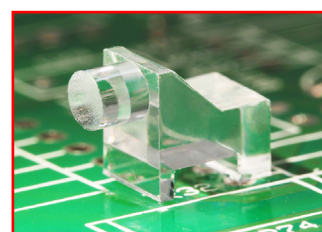
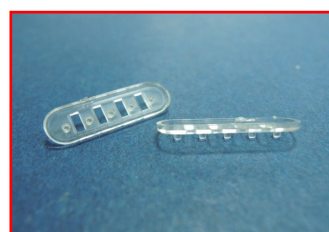
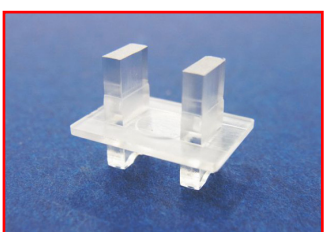
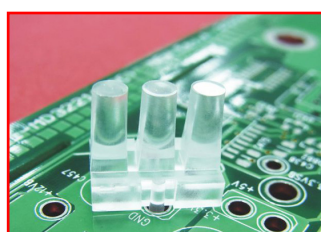
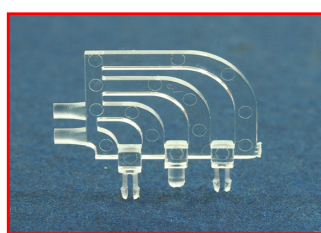
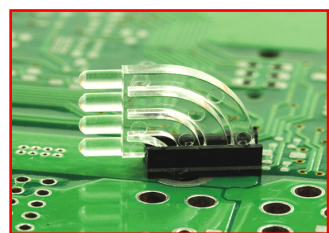
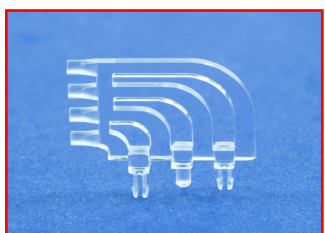
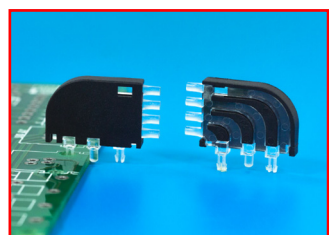
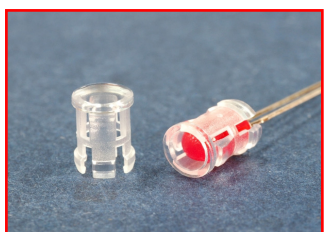
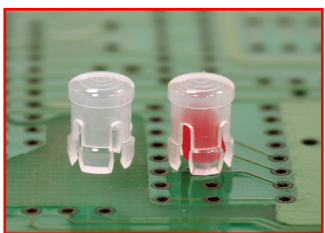
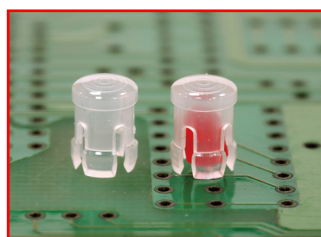
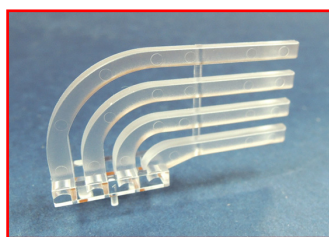

LED导光柱 LED LIGHT PIPE / LED导光盖 LENS CAP

LED遮光罩 LIGHT PIPE MASK

LED导光柱

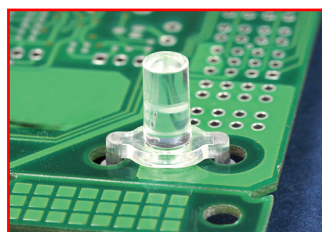
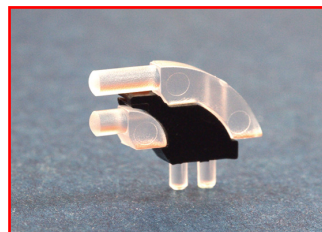
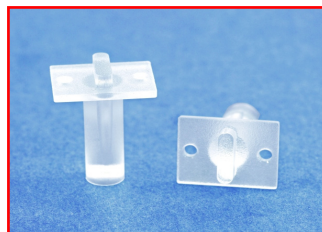
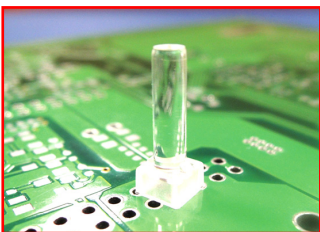
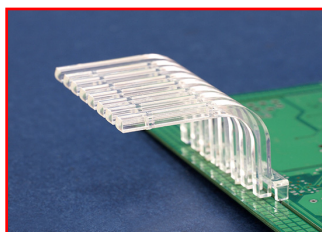
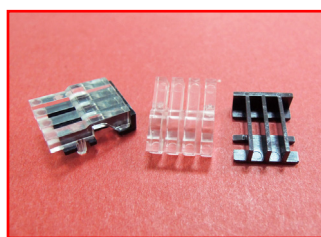
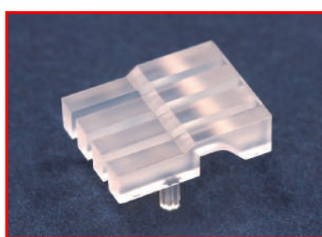

LED导光柱 LED LIGHT PIPE / LED导光盖 LENS CAP

LED遮光罩 LIGHT PIPE MASK

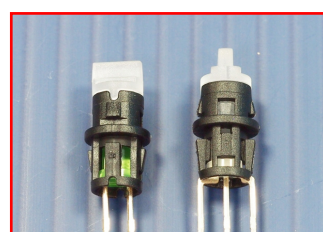
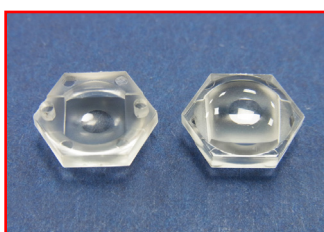
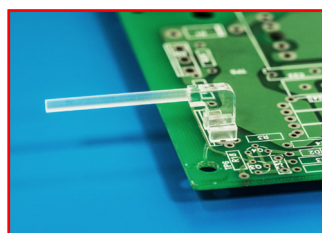
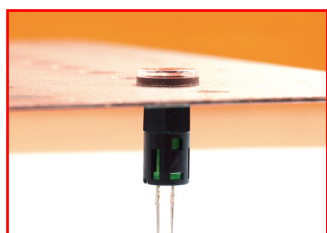
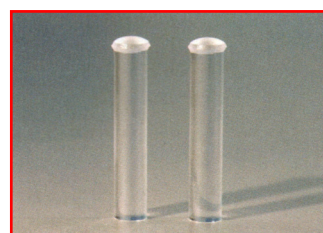
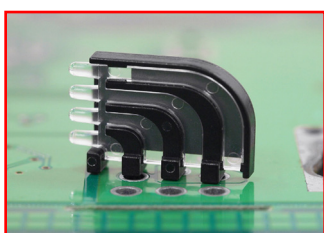
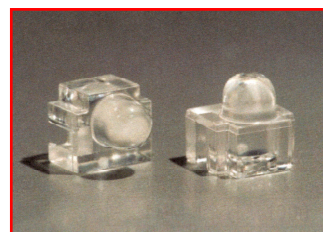
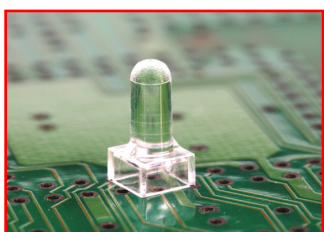
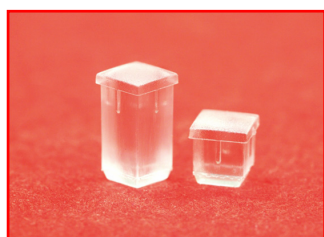
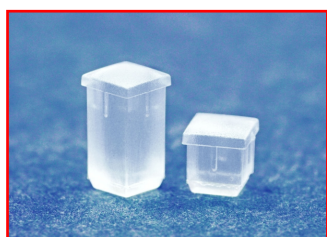

LED导光柱

LED导光盖 LENS CAP

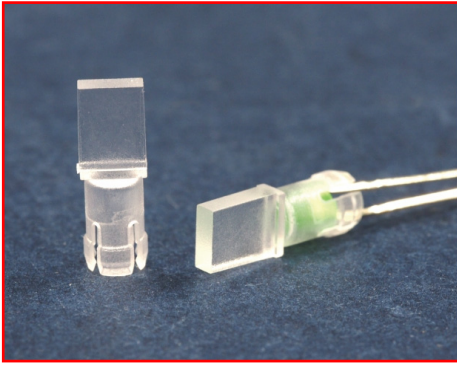

用途：将LED导光于机箱面板上，使亮度均匀、柔和。

MATERIAL : PC(UL)
 FLAME CLASS : 94V-0,94V-2
 COLOR : TRANSPARENT
 UNIT: mm

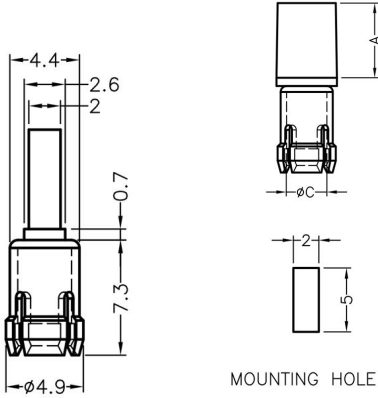

MOUNTING HOLE

CHASSIS $\varnothing 4.4$
 THICKNESS 1.57~3.2

PART NO	A	C	PACKAGE
LEDLP-001	6.3	$\varnothing 3.4$	1000
LEDLP-112	2.5	$\varnothing 3.4$	1000

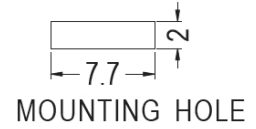

MOUNTING HOLE

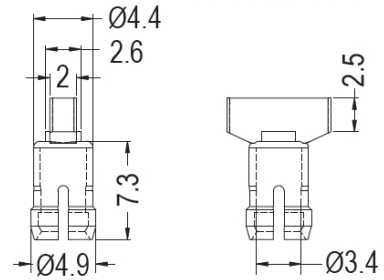

CHASSIS $\varnothing 4.4$
 THICKNESS 1.57~3.2

PART NO	PACKAGE
LEDLP-241	1000

LED导光柱 LED LIGHT PIPE



用途： 用于LED导光

MATERIAL : PC(UL)
 FLAME CLASS : 94V-0,94V-2
 COLOR : TRANSPARENT
 UNIT: mm

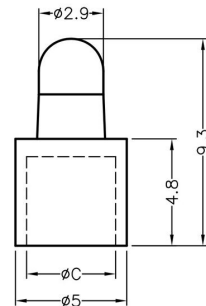
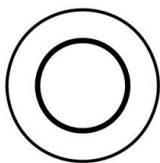

PART NO	C	PACKAGE
LEDLP-002	$\varnothing 4.0$	1000

LED导光柱 LED LIGHT PIPE

LED导光柱

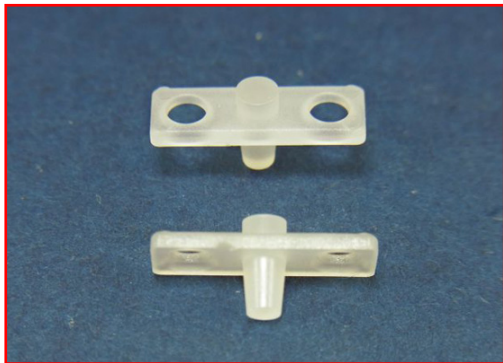

用途：使LED导光于机箱面板上，使光度显示均匀、柔和。

MATERIAL : PC(UL)

FLAME CLASS : 94V-2,94V-0

COLOR : TRANSPARENT

UNIT: mm

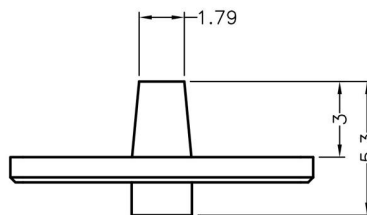
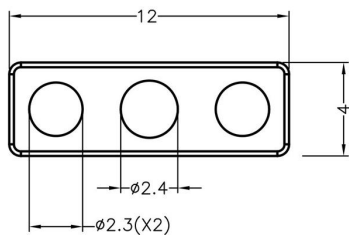

PART NO	PACKAGE
LEDLP-003	1000

LED导光柱 LED LIGHT PIPE



用途：使LED导光于机壳面板上，使光度均匀、柔和

MATERIAL : PC(UL)

FLAME CLASS : 94V-0,94V-2

COLOR : TRANSPARENT

UNIT: mm

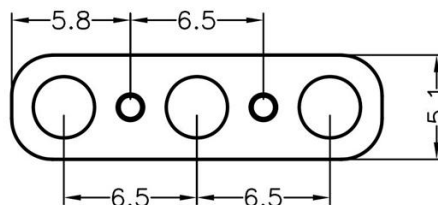
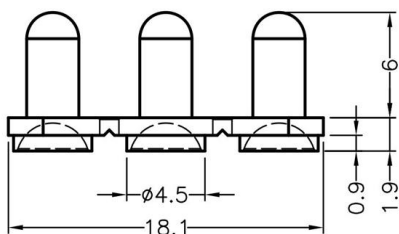

PART NO	PACKAGE
LEDLP-004	1000

LED导光柱 LED LIGHT PIPE



用途：使LED导光于机壳面板上，使光度均匀、柔和。

MATERIAL : PC(UL)

FLAME CLASS : 94V-0,94V-2

COLOR : TRANSPARENT

UNIT: mm

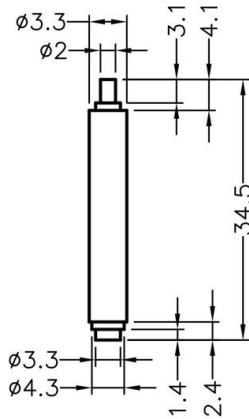

PART NO	PACKAGE
LEDLP-005	1000

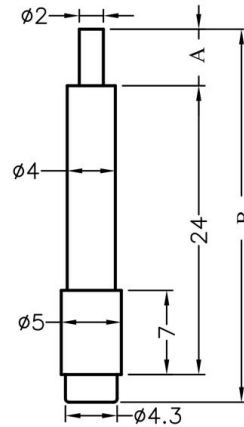

PART NO	A	B	PACKAGE
LEDLP-051	4.7	31.0	1000
LEDLP-052	1.7	28.0	1000

LED导光柱 LED LIGHT PIPE



用途：使LED导光于机壳面板上，使光度均匀、柔和

MATERIAL : PC(UL)

FLAME CLASS : 94V-0,94V-2

COLOR : TRANSPARENT

UNIT: mm

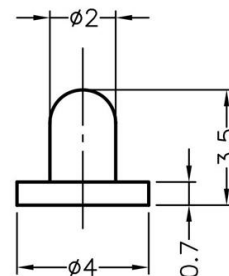

PART NO	PACKAGE
LEDLP-006	1000

LED导光柱 LED LIGHT PIPE

LED导光柱



用途：使LED导光到机壳面板上，光度均匀、柔和。

MATERIAL : PC(UL)

FLAME CLASS : 94V-0,94V-2

COLOR : TRANSPARENT

UNIT: mm

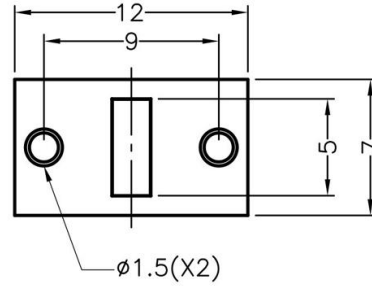
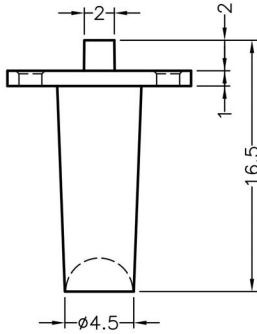

PART NO	PACKAGE
LEDLP-007	1000

LED导光柱 LED LIGHT PIPE



用途：使LED导光到机壳面板上，光度均匀、柔和

MATERIAL : PC(UL)

FLAME CLASS : 94V-0,94V-2

COLOR : TRANSPARENT

UNIT: mm

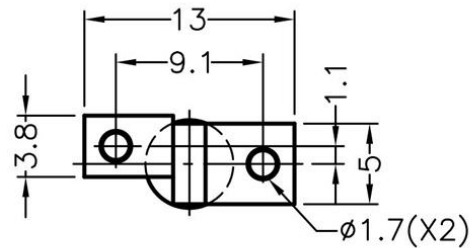
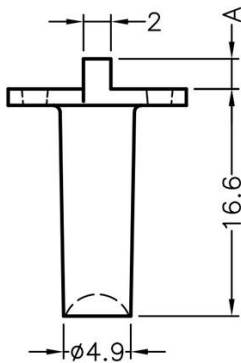

PART NO	A	PACKAGE
LEDLP-008	1.8	1000
LEDLP-009	2.2	1000

02
•
10

LED导光柱 LED LIGHT PIPE

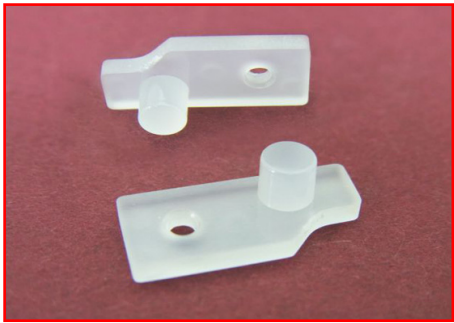

用途：使LED导光到机壳面板上，使光度均匀、柔和。

MATERIAL : PMMA

COLOR : TRANSPARENT

UNIT: mm

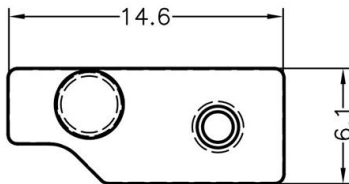
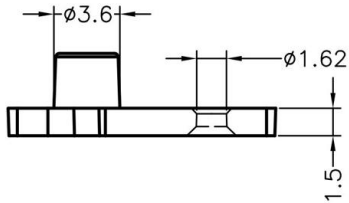

PART NO	PACKAGE
LEDLP-010	500

LED导光柱

LED导光盖 LENS CAP



用途：使LED导光到机壳面板上，使光度均匀、柔和

MATERIAL : PC(UL)

FLAME CLASS : 94V-0,94V-2

COLOR : TRANSPARENT

UNIT: mm

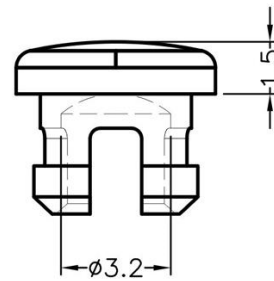
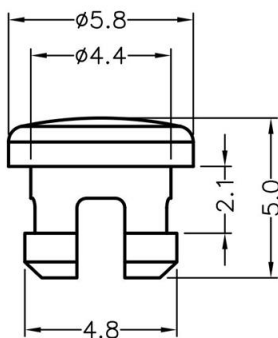

CHASSIS ϕ 4.6
THICKNESS 2.0

PART NO	PACKAGE
LEDLP-011	500

LED导光柱 LED LIGHT PIPE

LED导光柱

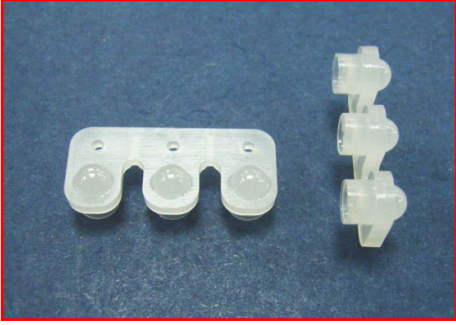

用途：使LED导光于机壳面板上，使光度均匀、柔和。

MATERIAL : PC(UL)

FLAME CLASS : 94V-0,94V-2

COLOR : TRANSPARENT

UNIT: mm

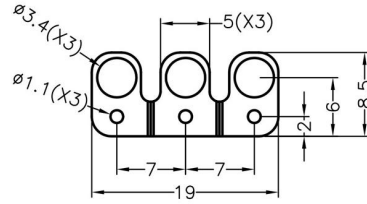
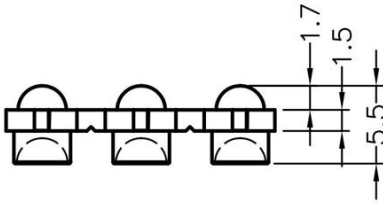

PART NO	PACKAGE
LEDLP-012	1000

LED导光柱 LED LIGHT PIPE

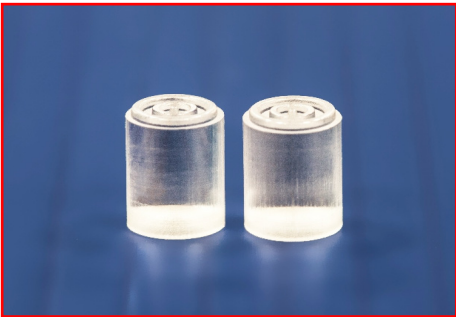

用途：用于LED导光柱

MATERIAL : PC(UL)

FLAME CLASS : 94V-0,94V-2

COLOR : TRANSPARENT

UNIT: mm

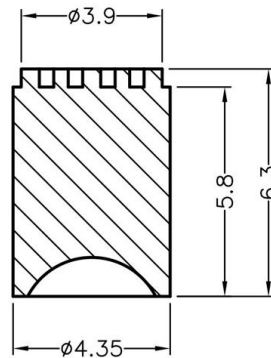

PART NO	PACKAGE
LEDLP-013	500

02
•
12

LED导光柱 LED LIGHT PIPE



用途：使LED导光于机壳面板上，使光度均匀、柔和。

MATERIAL : PC(UL)

FLAME CLASS : 94V-0,94V-2

COLOR : TRANSPARENT

UNIT: mm

PART NO	A	B	PACKAGE
LEDLP-014	15.75	3.4	1000
LEDLP-127	14.1	3.53	1000

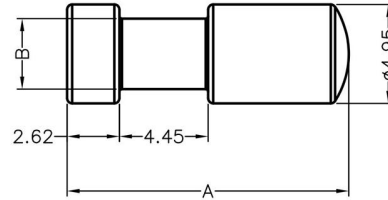

LED导光柱

LED导光柱 LED LIGHT PIPE

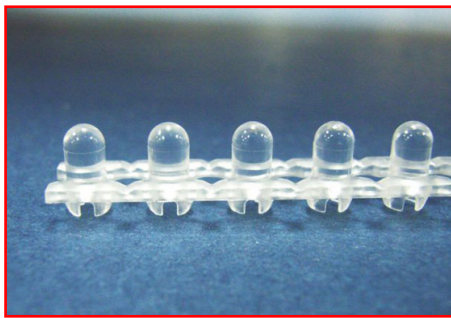

用途：使 LED 导光于机壳面板上，使光度均匀、柔和，可

MATERIAL : PC(UL)

FLAME CLASS : 94V-0,94V-2

COLOR : TRANSPARENT

UNIT: mm

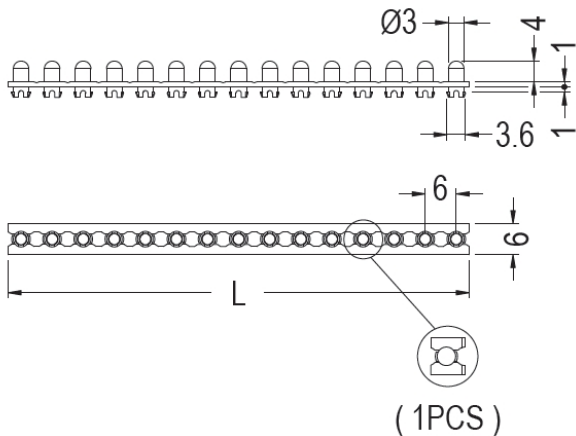
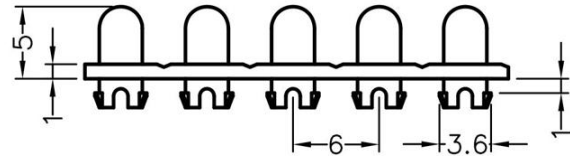
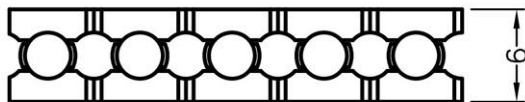

LEDLP-284

PART NO	L	PACKAGE
LEDLP-015	89.0	500
LEDLP-284	5.5	500
LEDLP-285	11.5	500
LEDLP-286	17.5	500
LEDLP-287	23.5	500
LEDLP-288	65.5	500
LEDLP-289	71.5	500
LEDLP-290	83.5	500

LED导光柱 LED LIGHT PIPE

LED导光柱

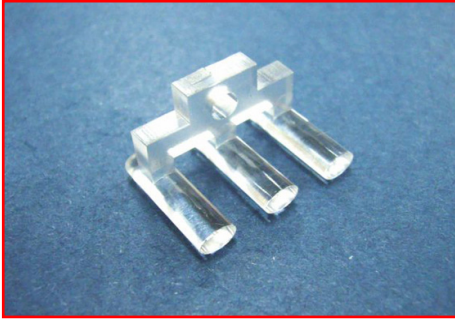

用途：置LED导光于机壳面板上，使亮度均匀、柔和。

MATERIAL : PC(UL)

FLAME CLASS : 94V-0,94V-2

COLOR : TRANSPARENT

UNIT: mm

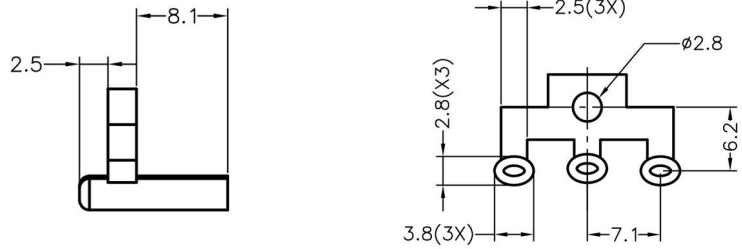

PART NO	PACKAGE
LEDLP-016	1000

LED导光柱 LED LIGHT PIPE



用途：用于LED导光柱。

MATERIAL : PC(UL)

FLAME CLASS : 94V-0,94V-2

COLOR : TRANSPARENT

UNIT: mm

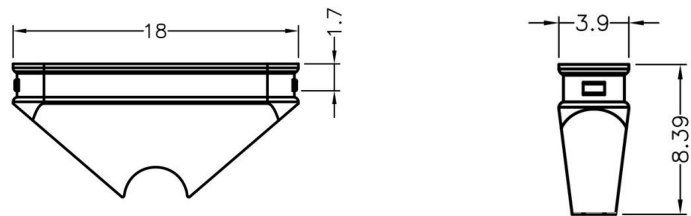

PART NO	PACKAGE
LEDLP-017	1000

LED导光柱 LED LIGHT PIPE



用途：用于LED导光柱

MATERIAL : PC(UL)

FLAME CLASS : 94V-0,94V-2

COLOR : TRANSPARENT

UNIT: mm

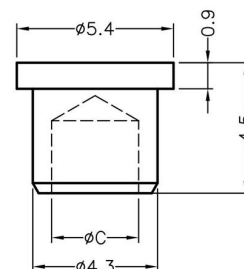

PART NO	C	PACKAGE
LEDLP-018	$\phi 3.0$	1000

02
•
14

LED导光柱 LED LIGHT PIPE

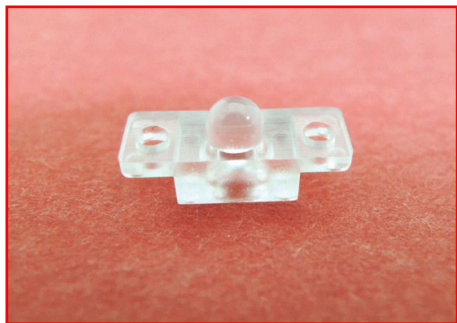

用途：使LED导光于机壳面板上，使光度均匀、柔和。

MATERIAL : PC(UL)

FLAME CLASS : 94V-0,94V-2

COLOR : TRANSPARENT

UNIT: mm

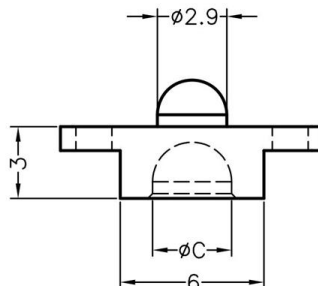
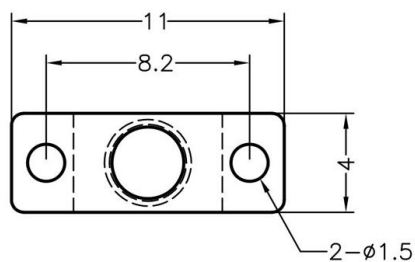

PART NO	PACKAGE
LEDLP-019	1000

LED导光柱 LED LIGHT PIPE

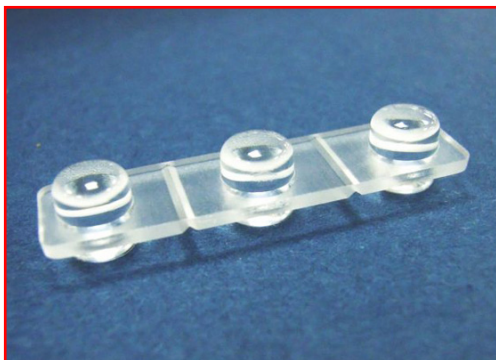

用途：置LED导光于机壳面板上，使亮度均匀、柔和。

MATERIAL : PMMA

COLOR : TRANSPARENT

UNIT: mm

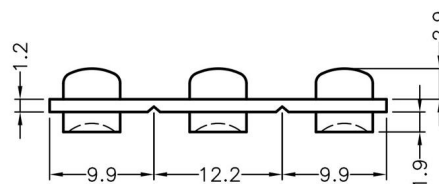
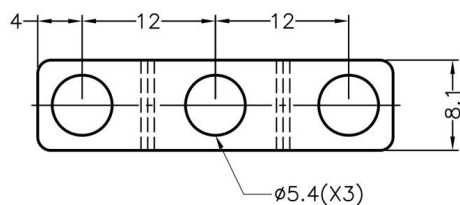

PART NO	PACKAGE
LEDLP-020	1000

LED导光柱 LED LIGHT PIPE

LED导光柱

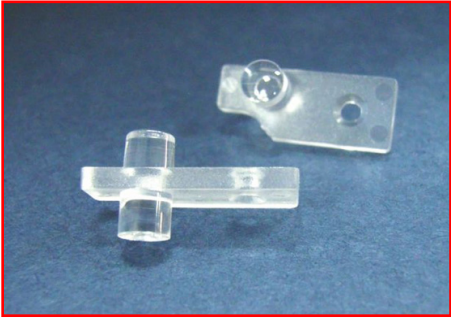

用途：使LED导光于机壳面板上，使光度均匀、柔和。

MATERIAL : PC(UL)

FLAME CLASS : 94V-0,94V-2

COLOR : TRANSPARENT

UNIT: mm

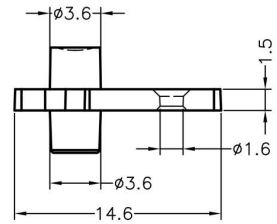
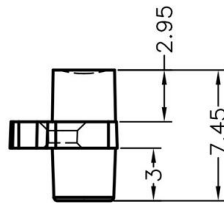
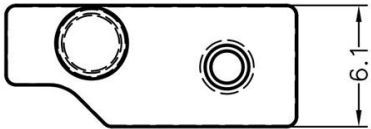

PART NO	PACKAGE
LEDLP-021	500

LED导光柱 LED LIGHT PIPE



用途：使LED导光于机壳面板上，使光度均匀、柔和。

MATERIAL : PC(UL)

FLAME CLASS : 94V-0,94V-2

COLOR : TRANSPARENT

UNIT: mm

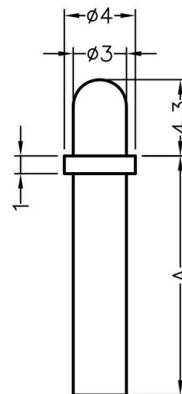

PART NO	A	PACKAGE
LEDLP-022	13.5	1000
LEDLP-023	8.7	1000
LEDLP-126	57.0	500

LED导光柱 LED LIGHT PIPE



用途： 用于LED导光柱。

MATERIAL : PC(UL)
 FLAME CLASS : 94V-0,94V-2
 COLOR : TRANSPARENT
 UNIT: mm

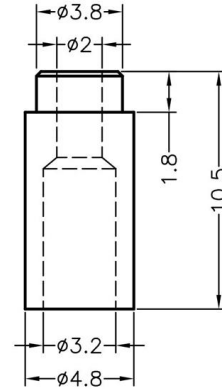
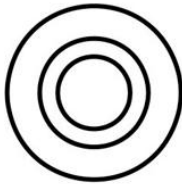

PART NO	PACKAGE
LEDLP-024	1000

LED导光柱

LED导光柱 LED LIGHT PIPE



用途： 使LED导光到机壳面板上，使光度均匀、柔和。

MATERIAL : PC(UL)
 FLAME CLASS : 94V-0,94V-2
 COLOR : TRANSPARENT
 UNIT: mm

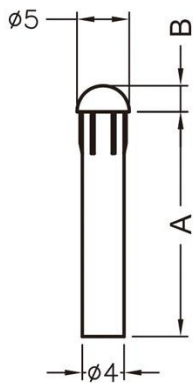

MOUNTING HOLE ØD

(规格 / 尺寸) 代码说明:

D : 装配孔

PART NO	A	B	D	PACKAGE
LEDLP-025	21.55	2.5	4.3	2000
LEDLP-129	43.5	2.5	4.3	1000
LEDLP-263	36.0	2.5	4.3	1000
LEDLP-130	30.0	2.5	4.3	1000
LEDLP-131	54.0	2.5	4.3	1000
LEDLP-168	8.5	2.5	4.2	2000
LEDLP-169	16.5	2.5	4.2	2000
LEDLP-170	37.5	2.5	4.3	1000
LEDLP-219	24.0	2.5	4.2	1000
LEDLP-268	7.0	2.5	4.2	2000
LEDLP-269	19.0	2.5	4.2	1000

LED导光柱 LED LIGHT PIPE

LED导光柱

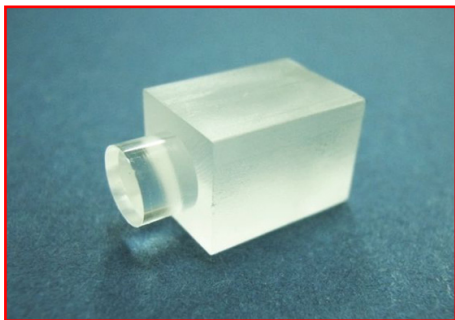

用途：使LED导光于机壳面板上，使光度均匀、柔和。

MATERIAL : PC(UL)

FLAME CLASS : 94V-0,94V-2

COLOR : TRANSPARENT

UNIT: mm

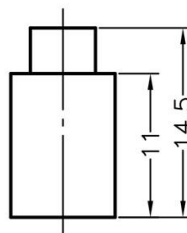
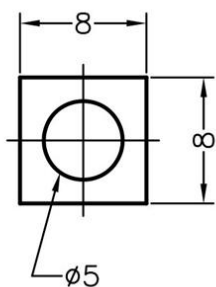

PART NO	PACKAGE
LEDLP-027	2000

LED导光柱 LED LIGHT PIPE



用途：可将LED导光到机器面板。

MATERIAL : PC(UL)

FLAME CLASS : 94V-0,94V-2

COLOR : TRANSPARENT

UNIT: mm

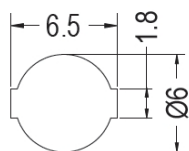

MOUNTING HOLE
THICKNESS 1.0

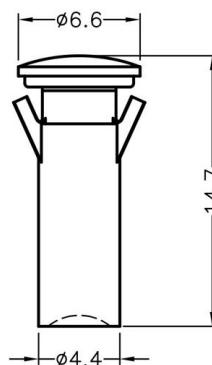

PART NO	PACKAGE
LEDLP-026	1000

LED导光柱 LED LIGHT PIPE



用途：使S.M.T LED导光于机壳面板上，使光度均匀、柔和

MATERIAL : PC(UL)

FLAME CLASS : 94V-0,94V-2

COLOR : TRANSPARENT

UNIT: mm

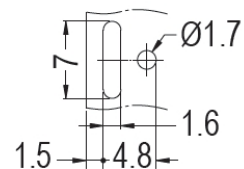
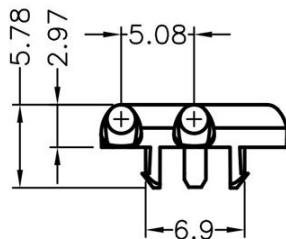
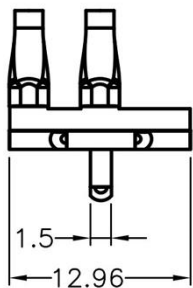

P.C.B THICKNESS 1.6

PART NO	PACKAGE
LEDLP-028	2000

LED导光柱 LED LIGHT PIPE



用途：使LED导光于机壳面板上，使光度均匀、柔和。

MATERIAL : PC(UL)

FLAME CLASS : 94V-0,94V-2

COLOR : TRANSPARENT

UNIT: mm

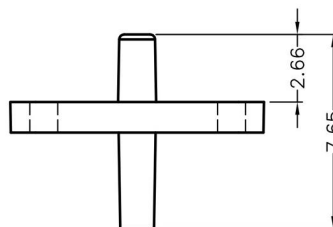
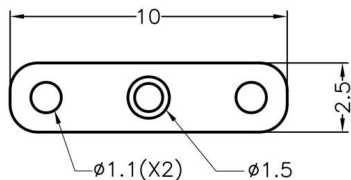

PART NO	PACKAGE
LEDLP-029	1000

LED导光柱 LED LIGHT PIPE

LED导光柱



用途：使LED导光于机壳面板上，使光度均匀、柔和。

MATERIAL : PC(UL)

FLAME CLASS : 94V-0,94V-2

COLOR : TRANSPARENT

UNIT: mm

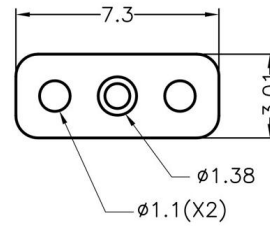
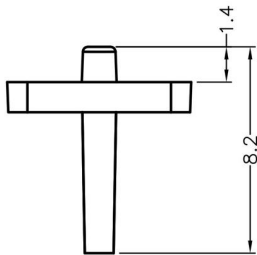

PART NO	PACKAGE
LEDLP-030	1000

LED导光柱 LED LIGHT PIPE



用途：使LED导光于机壳面板上，使光度均匀、柔和。

MATERIAL : PC(UL)

FLAME CLASS : 94V-0,94V-2

COLOR : TRANSPARENT

UNIT: mm

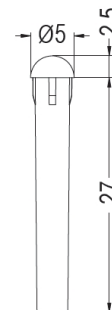
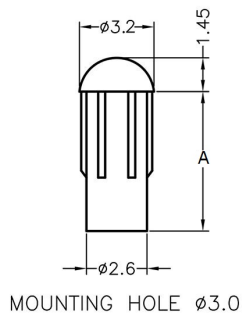

PART NO	A	PACKAGE
LEDLP-031	6.0	2000
LEDLP-244	13.0	2000
LEDLP-245	17.5	2000
LEDLP-246	27.5	1000
LEDLP-270	20.5	2000

MOUNTING HOLE $\phi 4.4$

PART NO	PACKAGE
LEDLP-303	1000

LED导光柱 LED LIGHT PIPE

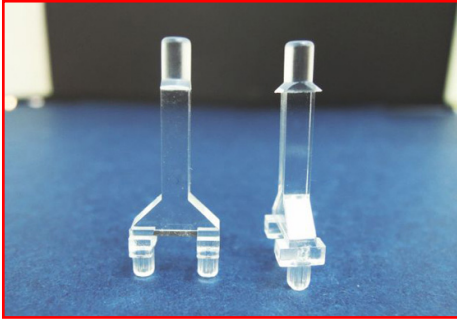

用途：用于S.M.T LED导光于机壳面板上，使光度均匀、

MATERIAL : PC(UL)

FLAME CLASS : 94V-0,94V-2

COLOR : TRANSPARENT

UNIT: mm

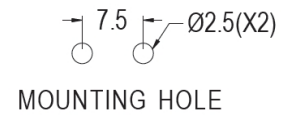
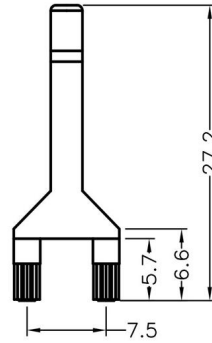
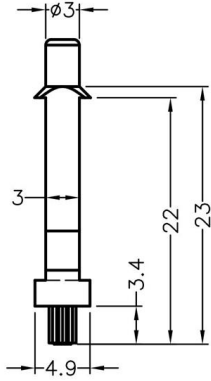

PART NO	PACKAGE
LEDLP-032	1000

LED导光柱 LED LIGHT PIPE



用途：使LED导光到机壳面板上，使光度均匀、柔和。

MATERIAL : PC(UL)

FLAME CLASS : 94V-0,94V-2

COLOR : TRANSPARENT

UNIT: mm

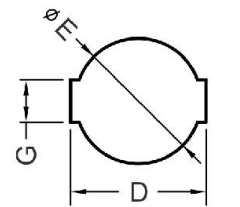
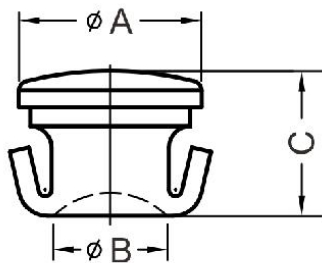

MOUNTING HOLE
THICKNESS : F

PART NO	A	B	C	D	E	F	G	PACKAGE
LEDLP-033	$\phi 5.6$	$\phi 3.5$	4.5	5.4	$\phi 5.0$	1.2	1.7	1000
LEDLP-034	$\phi 5.6$	$\phi 3.0$	4.5	5.4	$\phi 5.0$	1.2	1.7	1000
LEDLP-035	$\phi 4.8$	$\phi 3.4$	4.5	5.0	$\phi 4.3$	1.2	1.8	1000
LEDLP-128	$\phi 6.9$	$\phi 4.5$	3.8	6.75	$\phi 6.3$	0.7	2.0	1000

(规格 / 尺寸) 代码说明:

F : 装配版厚

LED导光柱 LED LIGHT PIPE

LED导光柱



用途：使LED导光于机壳面板上，使光度均匀、柔和。

MATERIAL : PC(UL)

FLAME CLASS : 94V-0,94V-2

COLOR : TRANSPARENT

UNIT: mm

PART NO	A	B	PACKAGE
LEDLP-036	24.0	29.0	1000
LEDLP-037	29.0	34.0	1000
LEDLP-038	20.5	25.5	1000

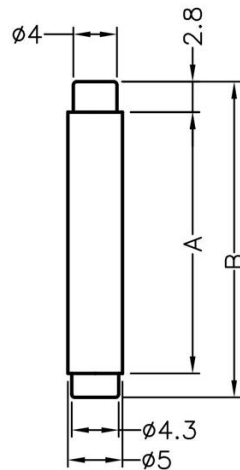

LED按键盖 LED PUSHBUTTON CAP



用途： 用于LED按键导光柱

MATERIAL : PC(UL)

FLAME CLASS : 94V-2

COLOR : TRANSPARENT

UNIT: mm

PART NO	PACKAGE
LEDLP-039	1000

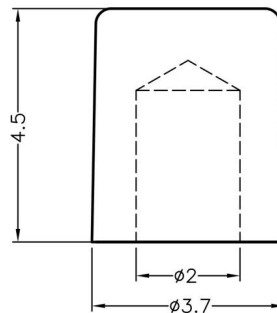

LED导光柱 LED LIGHT PIPE

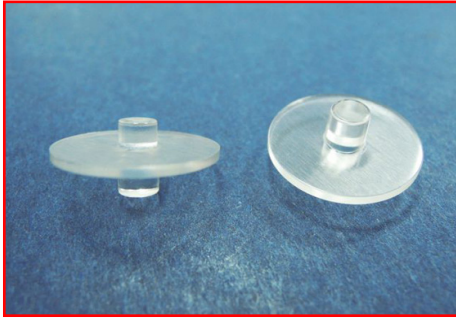

用途：使LED导光于机壳面板上，使光度均匀、柔和。

MATERIAL : PC(UL)

FLAME CLASS : 94V-0,94V-2

COLOR : TRANSPARENT

UNIT: mm

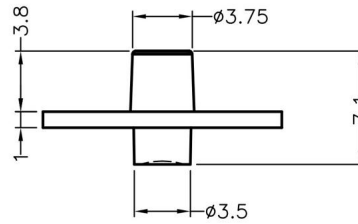
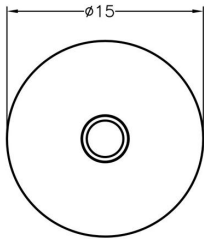

PART NO	PACKAGE
LEDLP-040	1000

LED导光柱 LED LIGHT PIPE

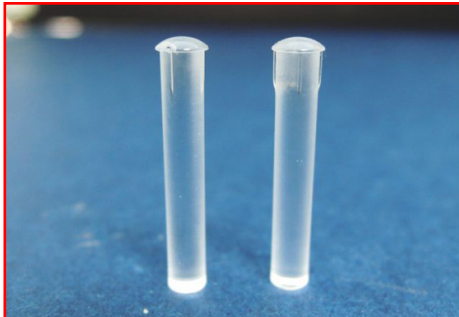

用途：置LED导光于机壳面板上，使亮度均匀、柔和。

MATERIAL : PC(UL)

FLAME CLASS : 94V-0,94V-2

COLOR : TRANSPARENT

UNIT: mm

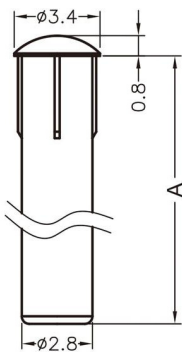

HOLE IN THICKNESS $\phi 3.0$

PART NO	A	PACKAGE
LEDLP-041	18.0	2000
LEDLP-221	7.2	1000
LEDLP-220	12.2	1000

LED导光柱 LED LIGHT PIPE

LED导光柱

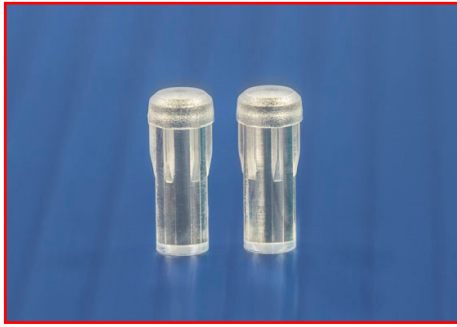

用途：使LED导光于机壳面板上，使光度均匀、柔和。

MATERIAL : PC(UL)

FLAME CLASS : 94V-0,94V-2

COLOR : TRANSPARENT

UNIT: mm

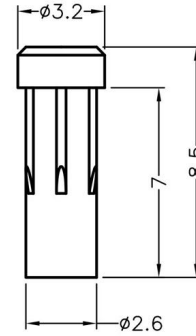

PART NO	PACKAGE
LEDLP-042	2000

PLASTIC MOUNTING HOLE $\phi 2.8$
METAL MOUNTING HOLE $\phi 3.0$

LED导光柱 LED LIGHT PIPE

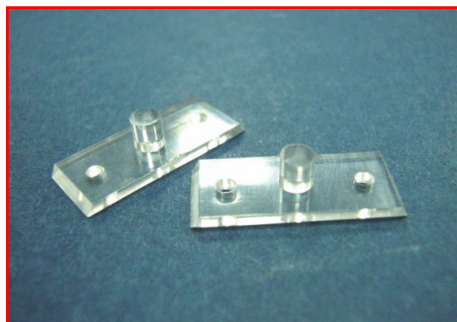

用途：置LED导光于机壳面板上，使亮度均匀、柔和。

MATERIAL : PC(UL)

FLAME CLASS : 94V-0,94V-2

COLOR : TRANSPARENT

UNIT: mm

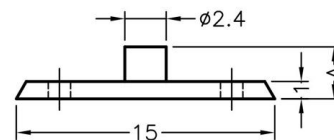
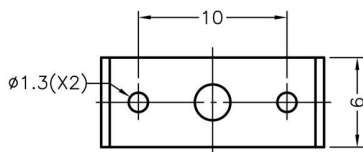

PART NO	A	PACKAGE
LEDLP-043	3.0	1000
LEDLP-044	3.7	1000

LED导光柱 LED LIGHT PIPE

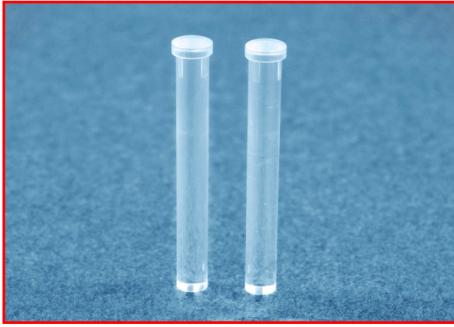

用途：使LED导光于机壳面板上，使光度均匀、柔和。

MATERIAL : PC(UL)

FLAME CLASS : 94V-0,94V-2

COLOR : TRANSPARENT

UNIT: mm

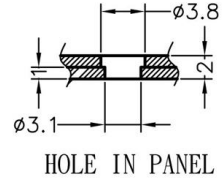
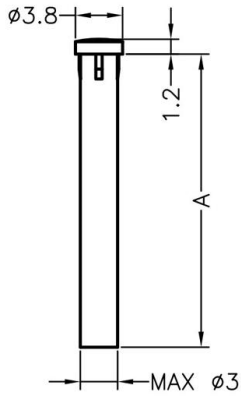

PART NO	A	PACKAGE
LEDLP-045	8.0	2000
LEDLP-046	23.6	2000
LEDLP-106	25.85	2000

LED导光柱 LED LIGHT PIPE



用途：置LED导光于机壳面板上，使光度均匀、柔和

MATERIAL : PC(UL)

FLAME CLASS : 94V-0,94V-2

COLOR : TRANSPARENT

UNIT: mm

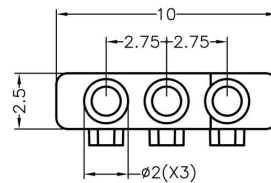
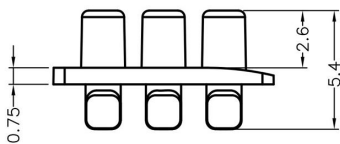

PART NO	PACKAGE
LEDLP-047	1000

LED导光柱 LED LIGHT PIPE

LED导光柱

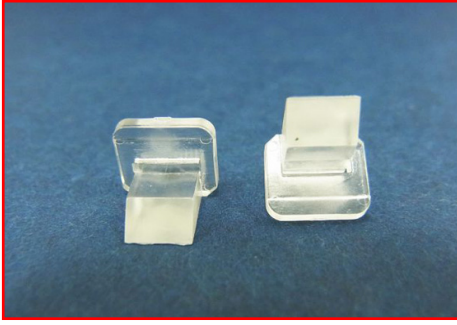

用途：使LED导光于机壳面板上，使光度均匀、柔和。

MATERIAL : PC(UL)

FLAME CLASS : 94V-0,94V-2

COLOR : TRANSPARENT

UNIT: mm

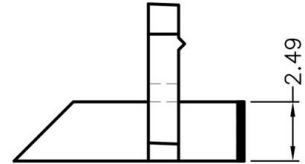
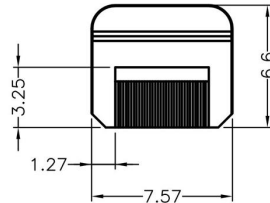
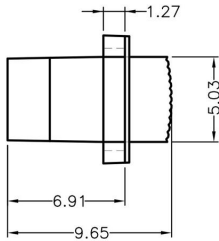

PART NO	PACKAGE
LEDLP-048	1000

LED导光柱 LED PIPE



用途：使LED导光于机壳面板上，使光度均匀、柔和

MATERIAL : PC(UL)

FLAME CLASS : 94V-0,94V-2

COLOR : TRANSPARENT

UNIT: mm

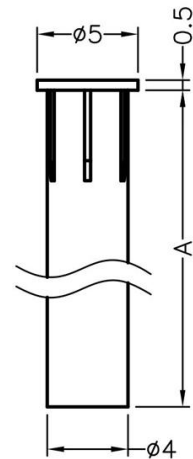
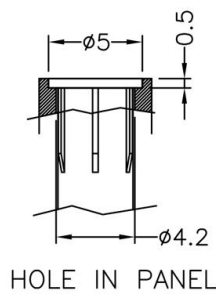
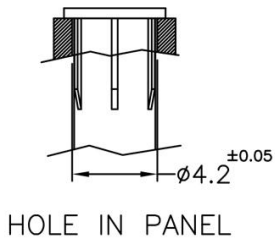

PART NO	A	PACKAGE
LEDLP-049	21.0	1000
LEDLP-050	28.0	1000
LEDLP-138	8.5	1000

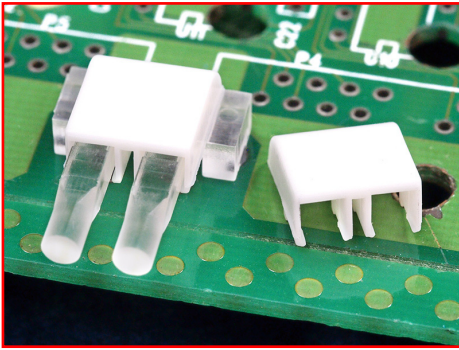

用途：LED导光柱遮光罩，遮蔽导光柱，避免邻近LED光线干扰，搭配LED导光柱LEDLP-064使用。

MATERIAL : PC(UL)
 FLAME CLASS : 94V-0,94V-2
 COLOR : NATURAL/BLACK
 UNIT: mm

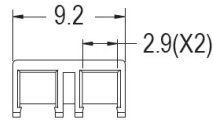
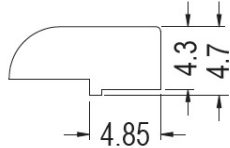
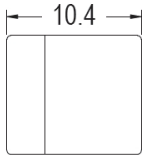

PART NO	PACKAGE
LEDPH-4	1000

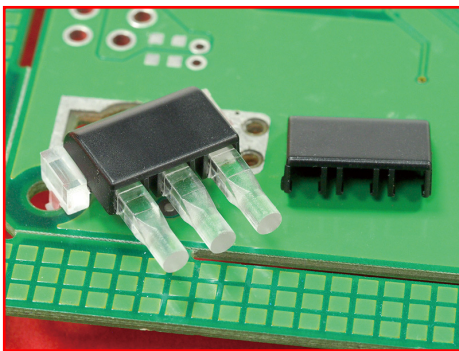

用途：LED导光柱遮光罩，遮蔽导光柱，避免邻近LED光线干扰，搭配LED导光柱LEDLP-074使用。

MATERIAL : PC+ABS(UL)
 FLAME CLASS : 94V-0
 COLOR : BLACK
 UNIT: mm

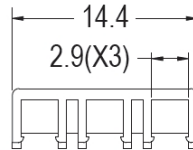
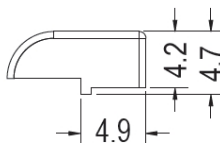
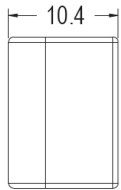

PART NO	PACKAGE
LEDPH-3	1000

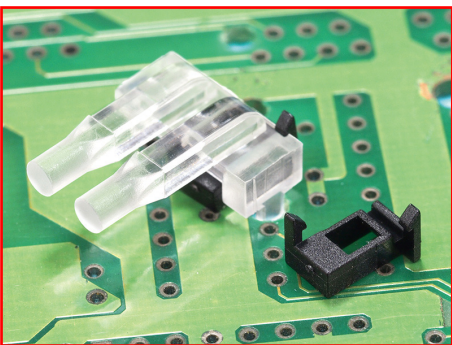

用途：LED导光柱遮光罩，遮蔽导光柱，避免邻近LED光线干扰，搭配LED导光柱LEDLP-053~LEDLP-089使用。

MATERIAL : NYLON 66(UL)
 FLAME CLASS : 94V-0/94V-2
 COLOR : BLACK
 UNIT: mm

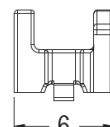
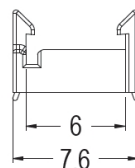
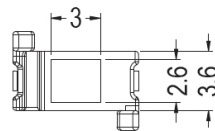
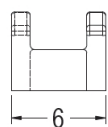
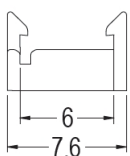
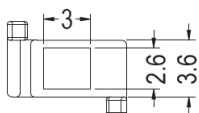

PART NO	PACKAGE
LEDPH-1	1000

PART NO	PACKAGE
LEDPH-7	1000

LED导光柱 LED LIGHT PIPE

LED导光柱

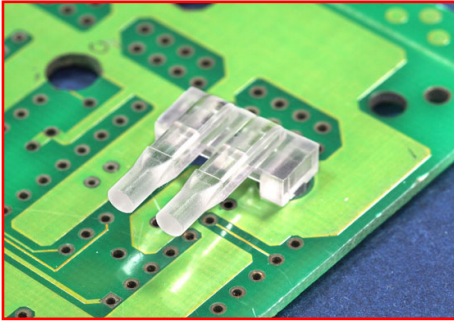

用途：将S.M.T LED导光到机壳面板上，使光度均匀、柔和。
此系列为单个导光柱。可配合LED遮光罩 LEDPH-1和遮光罩LEDPH-7使用，避免干扰附近LED光线。

MATERIAL : PC(UL)
FLAME CLASS : 94V-0,94V-2
COLOR : TRANSPARENT
UNIT: mm

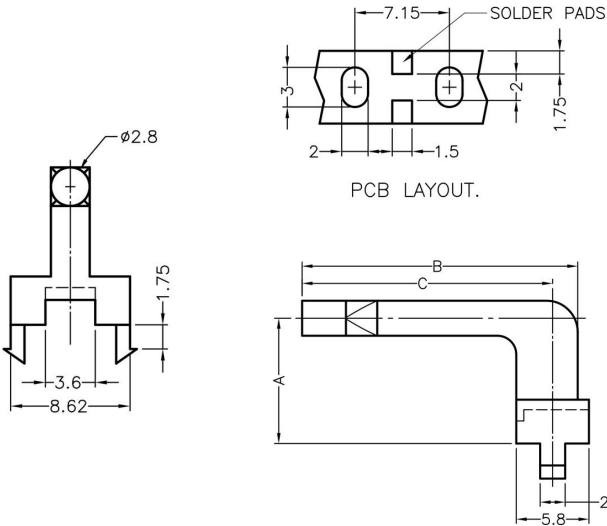

PART NO	A	B	C	PACKAGE
LEDLP-053	5.0	16.0	14.0	1000
LEDLP-054	5.0	19.0	17.0	1000
LEDLP-055	5.0	22.0	20.0	1000
LEDLP-056	10.0	16.0	14.0	1000
LEDLP-057	10.0	19.0	17.0	1000
LEDLP-058	10.0	22.0	20.0	1000
LEDLP-059	10.0	27.0	25.0	1000
LEDLP-060	15.0	16.0	14.0	1000
LEDLP-061	15.0	19.0	17.0	1000
LEDLP-062	15.0	22.0	20.0	1000

LED导光柱 LED LIGHT PIPE

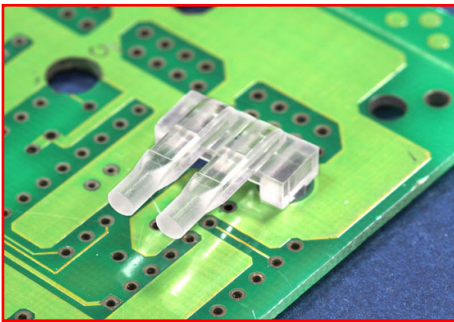

用途：将S.M.T LED导光到机壳面板上,使光度均匀、柔和。
此系列为2个水平并排个导光柱。可配合LED遮光罩 LEDPH-1和遮光罩LEDPH-7使用，避免干扰附近LED光线。

MATERIAL : PC(UL)
FLAME CLASS : 94V-0,94V-2
COLOR : TRANSPARENT
UNIT: mm

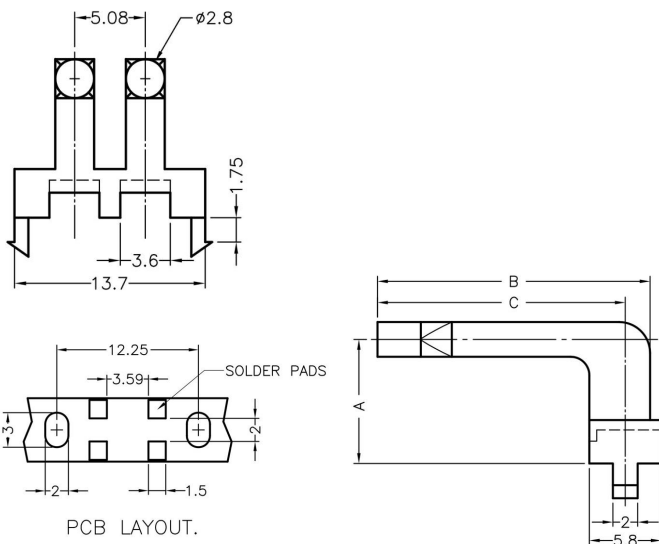

PART NO	A	B	C	PACKAGE
LEDLP-063	5.0	16.0	14.0	1000
LEDLP-064	5.0	19.0	17.0	1000
LEDLP-065	5.0	22.0	20.0	1000
LEDLP-066	10.0	16.0	14.0	1000
LEDLP-067	10.0	19.0	17.0	1000
LEDLP-068	10.0	22.0	20.0	1000
LEDLP-069	15.0	16.0	14.0	1000
LEDLP-070	15.0	19.0	17.0	1000
LEDLP-071	15.0	22.0	20.0	1000

LEDLP-064有专用LED遮光罩LEDPH-4

LED导光柱 LED LIGHT PIPE

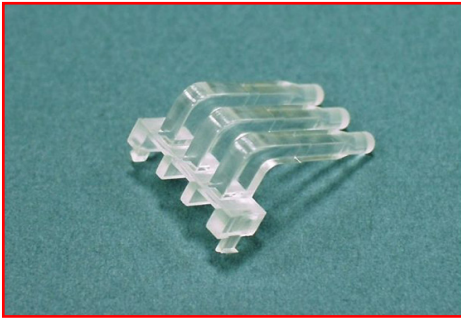

用途：将S.M.T LED导光到机壳面板上，使光度均匀、柔和。
此系列为3个水平并排个导光柱。可配合LED遮光罩
LEDPH-1和遮光罩LEDPH-7使用，避免干扰附近LED光
线。

MATERIAL : PC(UL)

FLAME CLASS : 94V-0,94V-2

COLOR : TRANSPARENT

UNIT: mm

PART NO	A	B	C	PACKAGE
LEDLP-072	5.0	16.0	14.0	500
LEDLP-073	5.0	19.0	17.0	500
LEDLP-074	5.0	22.0	20.0	500
LEDLP-075	10.0	16.0	14.0	500
LEDLP-076	10.0	19.0	17.0	500
LEDLP-077	10.0	22.0	20.0	500
LEDLP-078	15.0	16.0	14.0	500
LEDLP-079	15.0	19.0	17.0	500
LEDLP-080	15.0	22.0	20.0	500
LEDLP-271	5.0	14.0	12.0	500

LEDLP-074有专用LED遮光罩LEDPH-3

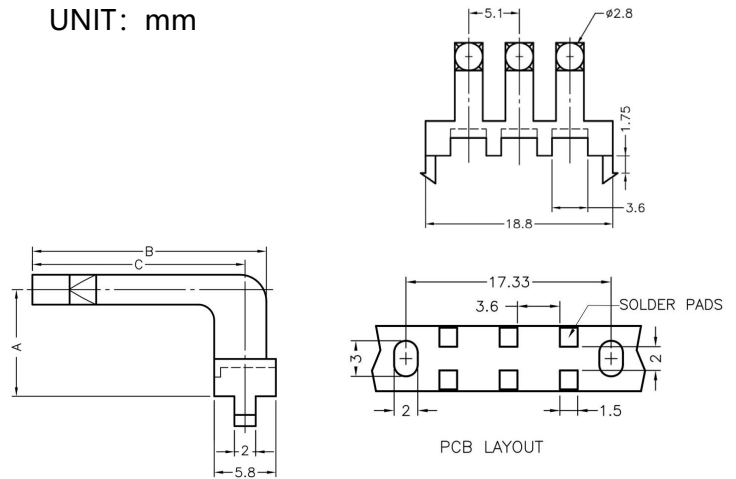

LED导光柱

LED导光柱 LED LIGHT PIPE

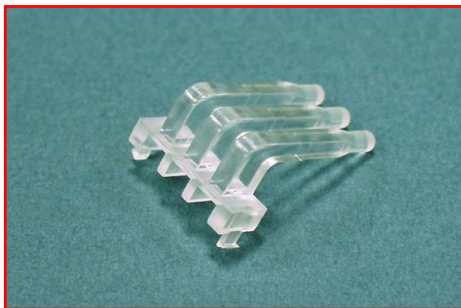

用途：将S.M.T LED导光到机壳面板上，使光度均匀、柔和。
此系列为4个水平并排个导光柱。可配合LED遮光罩
LEDPH-1和遮光罩LEDPH-7使用，避免干扰附近LED光
线。

MATERIAL : PC(UL)

FLAME CLASS : 94V-0,94V-2

COLOR : TRANSPARENT

UNIT: mm

PART NO	A	B	C	PACKAGE
LEDLP-081	5.0	16.0	14.0	500
LEDLP-082	5.0	19.0	17.0	500
LEDLP-083	5.0	22.0	20.0	500
LEDLP-084	10.0	16.0	14.0	500
LEDLP-085	10.0	19.0	17.0	500
LEDLP-086	10.0	22.0	20.0	500
LEDLP-087	15.0	16.0	14.0	500
LEDLP-088	15.0	19.0	17.0	500
LEDLP-089	15.0	22.0	20.0	500

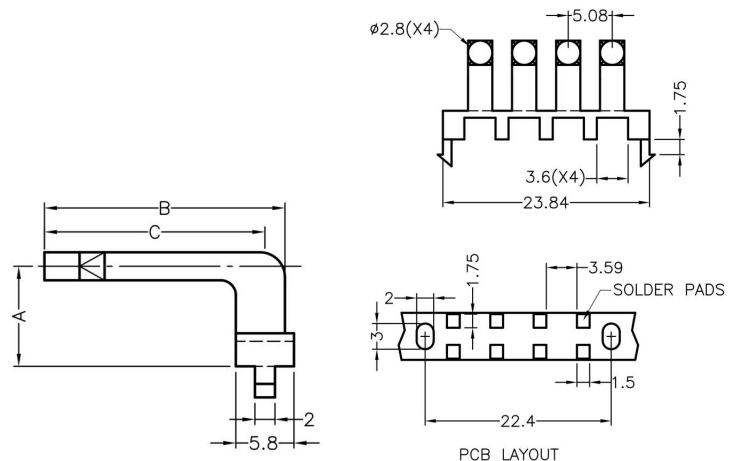

LED导光柱 LED LIGHT PIPE

LED导光柱

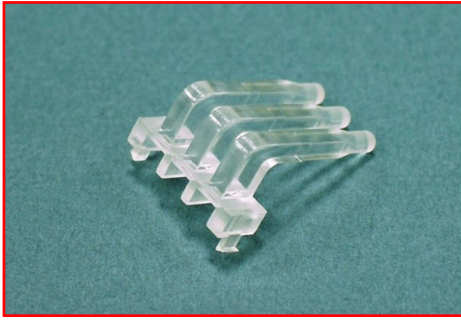

用途：将S.M.T LED导光至机壳面板上，使光度均匀、柔和。

MATERIAL : PC(UL)

FLAME CLASS : 94V-0,94V-2

COLOR : TRANSPARENT

UNIT: mm

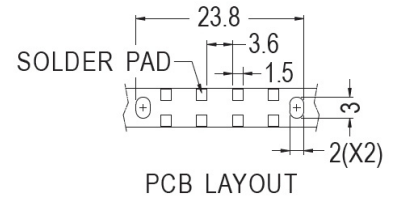
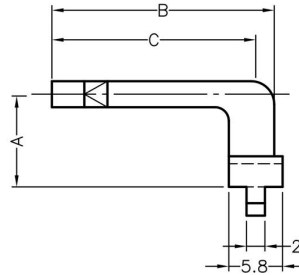
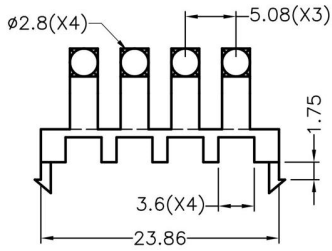

PART NO	A	B	C	PACKAGE
LEDLP-092	5.0	18.0	16.0	100
LEDLP-093	10.0	24.0	22.0	100

LED导光柱 LED PIPE

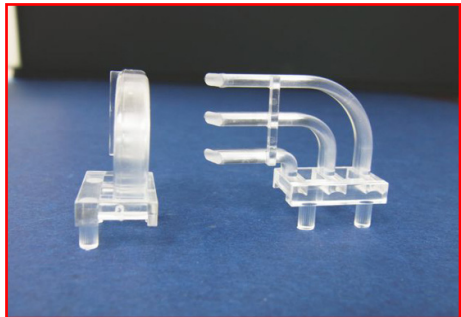

用途：将S.M.T LED导光至机壳面板上，使光度均匀、柔和。

MATERIAL : PC(UL)

FLAME CLASS : 94V-0,94V-2

COLOR : TRANSPARENT

UNIT: mm

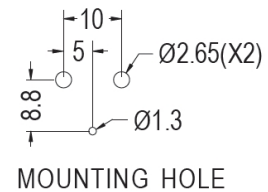
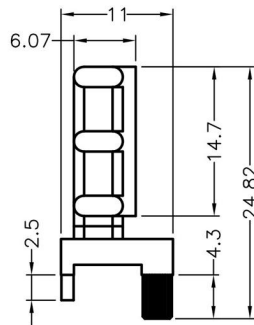
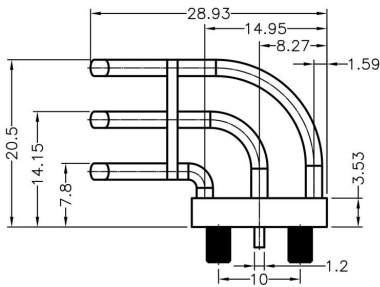

PART NO	PACKAGE
LEDLP-091	1000

LED导光柱 LED LIGHT PIPE



用途：将S.M.T LED导光到机壳面板上，使光度均匀、柔和。

MATERIAL : PC(UL)

FLAME CLASS : 94V-0,94V-2

COLOR : TRANSPARENT

UNIT: mm

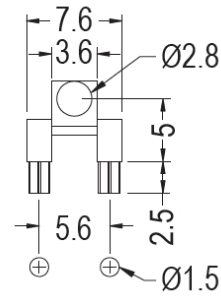
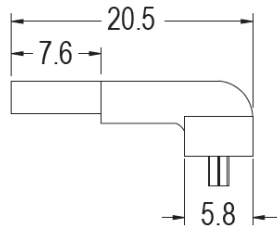

MOUNTING HOLE

PART NO	PACKAGE
LEDLP-090	1000

LED导光柱 LED LIGHT PIPE

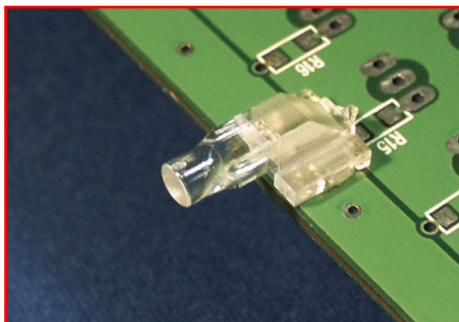

用途：将S.M.T LED导光至机壳面板上，使光度均匀、柔和。

MATERIAL : PC(UL)

FLAME CLASS : 94V-0,94V-2

COLOR : TRANSPARENT

UNIT: mm

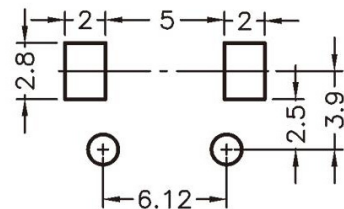
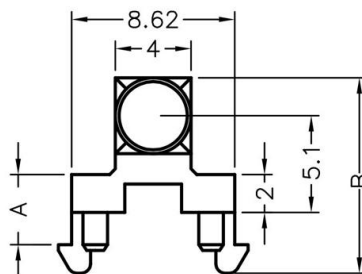
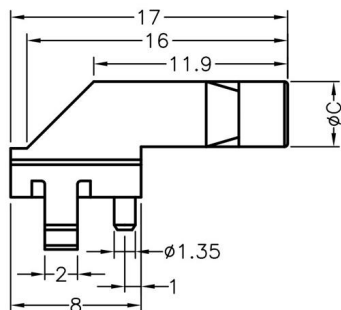

MOUNTING HOLES

PART NO	A	B	C	PACKAGE
LEDLP-094	3.7	10.3	4.0	2000
LEDLP-095	4.1	10.7	2.6	2000

LED导光柱 LED LIGHT PIPE

LED导光柱

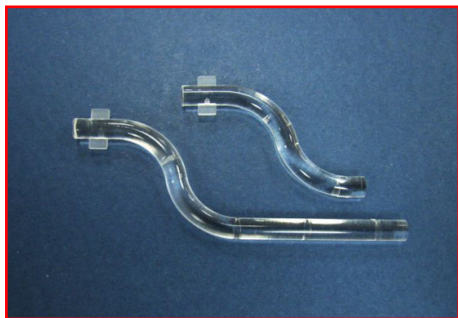

用途：用于LED导光柱。

MATERIAL : PMMA

COLOR : TRANSPARENT

UNIT: mm

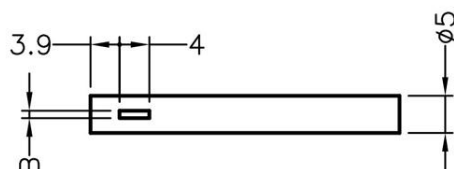
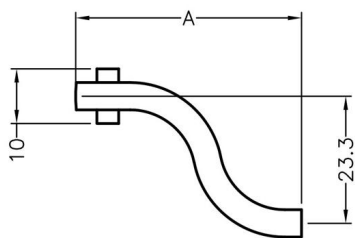

PART NO	A	B	PACKAGE
LEDLP-096	41.5	1.3	250
LEDLP-097	76.5	1.2	100

LED导光柱 LED LIGHT PIPE



用途：用于LED导光柱。

MATERIAL : PC(UL)

FLAME CLASS : 94V-0

COLOR : TRANSPARENT

UNIT: mm

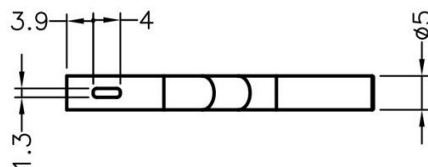
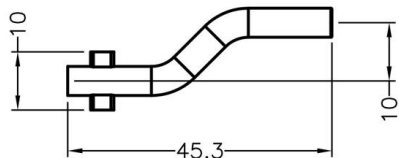

PART NO	PACKAGE
LEDLP-098	250

LED导光柱 LED LIGHT PIPE



用途：置LED导光于机壳面板上，使亮度均匀、柔和。

MATERIAL : PC(UL)

FLAME CLASS : 94V-0,94V-2

COLOR : TRANSPARENT

UNIT: mm

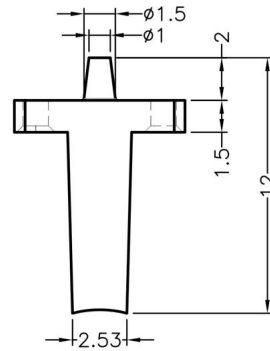
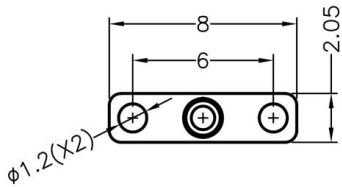

PART NO	PACKAGE
LEDLP-099	500

LED导光柱 LED LIGHT PIPE



用途：使 LED 导光于机壳面板上，使光度均匀、柔和

MATERIAL : PC(UL)

FLAME CLASS : 94V-0,94V-2

COLOR : TRANSPARENT

UNIT: mm

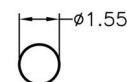
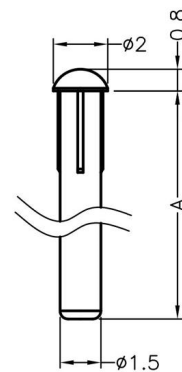

MOUNTING HOLE

PART NO	A	PACKAGE
LEDLP-100	20.0	2000
LEDLP-101	21.8	2000
LEDLP-136	29.2	2000
LEDLP-142	10.16	2000

LED导光柱 LED LIGHT PIPE

LED导光柱

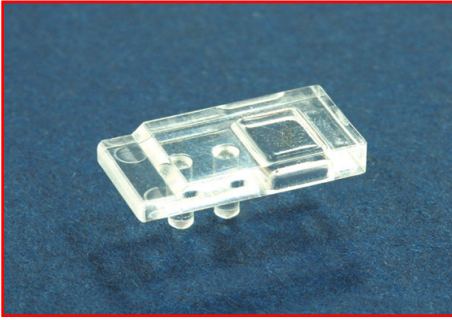

用途：置LED导光于机壳面板上，使光度均匀、柔和

MATERIAL : PC(UL)

FLAME CLASS : 94V-0,94V-2

COLOR : TRANSPARENT

UNIT: mm

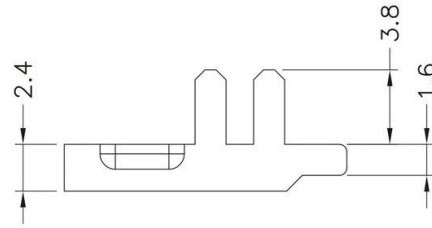
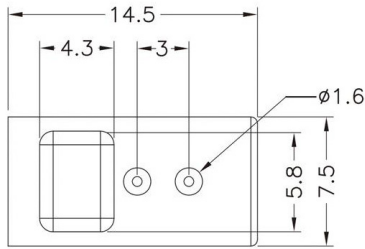

PART NO	PACKAGE
LEDLP-102	1000

LED导光柱 LED LIGHT PIPE



用途：置LED导光于机壳面板上，使亮度均匀、柔和。

MATERIAL : PC(UL)

FLAME CLASS : 94V-0,94V-2

COLOR : TRANSPARENT

UNIT: mm

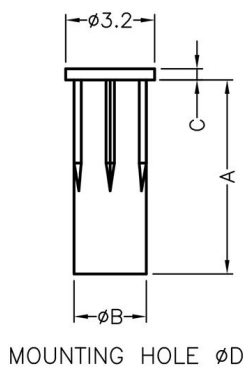

PART NO	A	B	C	D	PACKAGE
LEDLP-103	7.0	2.6	0.4	3.0	2000
LEDLP-145	25.0	2.6	0.4	3.0	2000
LEDLP-146	10.05	2.5	0.45	2.8	2000
LEDLP-273	4.8	2.6	0.4	3.0	2000
LEDLP-222	11.0	2.6	0.45	2.8	2000
LEDLP-304	15.0	2.5	0.45	3.2	2000

LED导光柱 LIGHT LED PIPE



用途：置LED导光于机壳面板上，使亮度均匀、柔和。

MATERIAL : PC(UL)

FLAME CLASS : 94V-0,94V-2

COLOR : TRANSPARENT

UNIT: mm

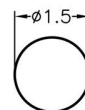
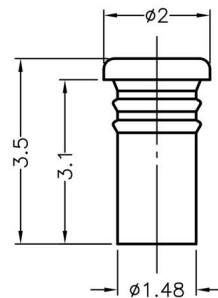

MOUNTING HOLE

PART NO	PACKAGE
LEDLP-104	2000

LED导光柱

LED导光柱 LED LIGHT PIPE



用途：置LED导光于机壳面板上，使亮度均匀、柔和。

MATERIAL : PC(UL)

FLAME CLASS : 94V-0,94V-2

COLOR : TRANSPARENT

UNIT: mm

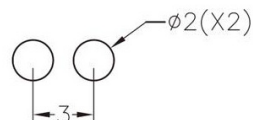
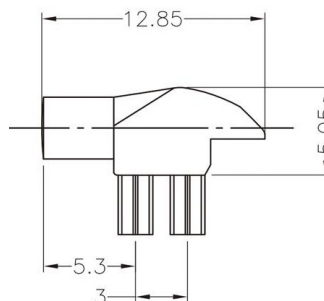
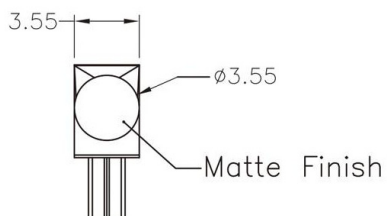

MOUNTING HOLE

PART NO	PACKAGE
LEDLP-105	1000

LED导光柱 LED LIGHT PIPE

LED导光柱



用途：置LED导光于机壳面板上，使亮度均匀、柔和。

MATERIAL : PC(UL)
 FLAME CLASS : 94V-0,94V-2
 COLOR : TRANSPARENT
 UNIT: mm

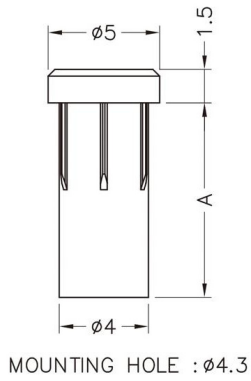

PART NO	A	PACKAGE
LEDLP-107	4.0	1000
LEDLP-108	8.5	1000

LED导光柱 LED LIGHT PIPE



用途：置S.M.T LED导光于机壳面板上，使亮度均匀、柔和。

MATERIAL : PC(UL)
 FLAME CLASS : 94V-0,94V-2
 COLOR : TRANSPARENT
 UNIT: mm

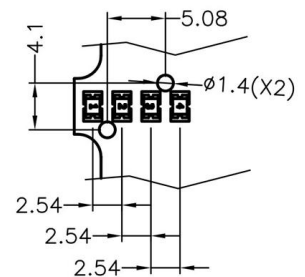
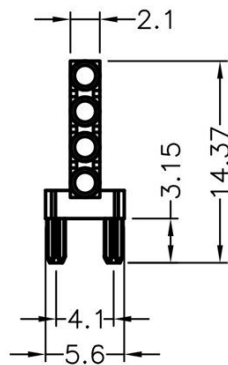
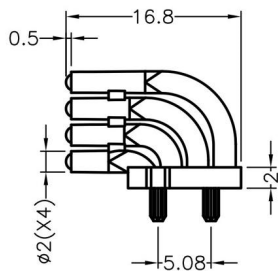

HOLE FOR PCB
 PCB THICKNESS 1.6mm

PART NO	PACKAGE
LEDLP-109	500

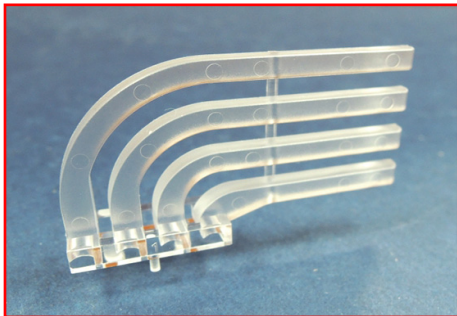

用途：置S.M.T LED导光于机壳面板上，使亮度均匀、柔和。

MATERIAL : PC(UL)

FLAME CLASS : 94V-0,94V-2

COLOR : TRANSPARENT

UNIT: mm

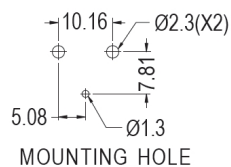
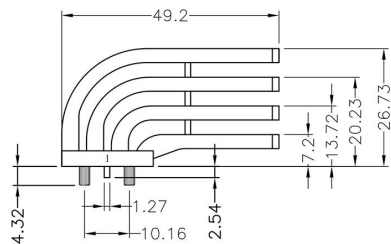
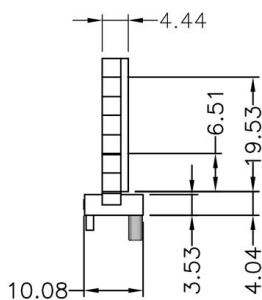

PART NO	PACKAGE
LEDLP-110	500

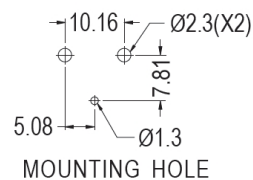
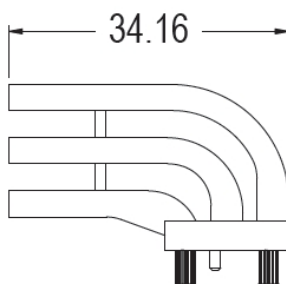
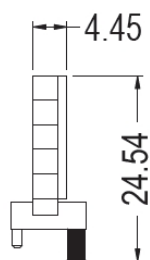

PART NO	PACKAGE
LEDLP-274	500

LED导光盖 LENS CAP

LED导光柱

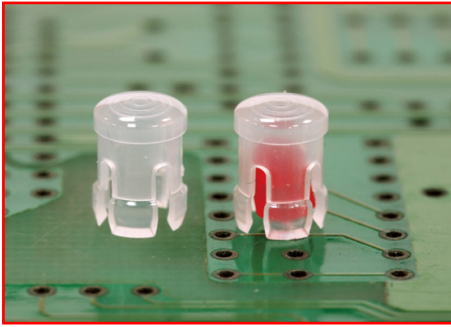

用途：将LED导光于机壳面板上，使亮度均匀、柔和。配合

MATERIAL : PC(UL)

FLAME CLASS : 94V-0,94V-2

COLOR : TRANSPARENT

UNIT: mm

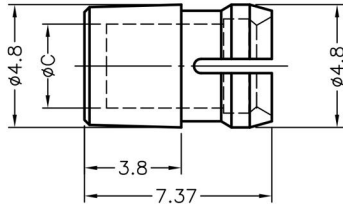

CHASSIS $\phi 4.4$
THICKNESS 1.57~3.2



PART NO	PACKAGE
LEDLP-113	2000

LED导光盖 LENS CAP



用途：将LED导光于机壳面板上，使亮度均匀、柔和。

MATERIAL : PC(UL)

FLAME CLASS : 94V-0,94V-2

COLOR : TRANSPARENT

UNIT: mm

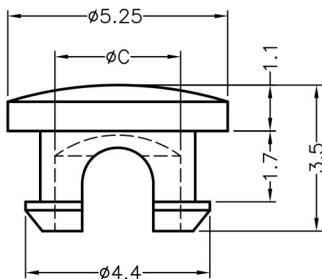

CHASSIS $\phi 3.6$
THICKNESS 0.8~1.6

PART NO	C	PACKAGE
LEDLP-114	$\phi 3.0$	1000

LED导光盖 LENS CAP

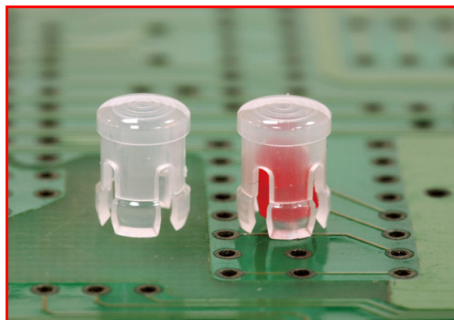

用途：可快速将 $\varnothing 3\text{mm}$ 的LED固定于机器面板上。搭配LED座套LEDT-01, 可更紧配稳固。

MATERIAL : PC(UL)

FLAME CLASS : 94V-0,94V-2

COLOR : TRANSPARENT

UNIT: mm



CHASSIS $\varnothing 4.4$
THICKNESS 1.57~3.2

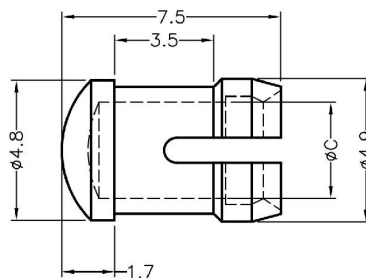

PART NO	C	PACKAGE
LEDLP-115	$\varnothing 3.3$	1000

LED导光盖 LENS CAP

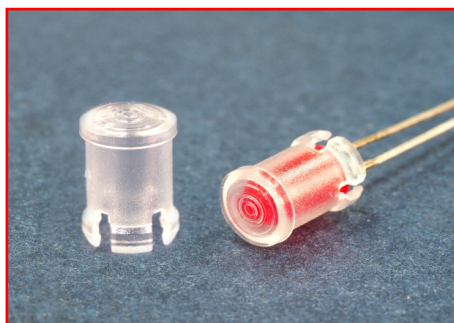

用途：可快速将 $\varnothing 5$ LED固定于机器面板上,使亮度均匀、柔和

MATERIAL : PC(UL)

FLAME CLASS : 94V-0,94V-2

COLOR : TRANSPARENT

UNIT: mm

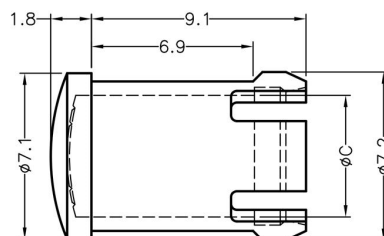

CHASSIS $\varnothing 6.4$
THICKNESS 0.8~6.35

PART NO	C	PACKAGE
LEDLP-116	$\varnothing 5.1$	1000

LED导光盖 LENS CAP

LED导光柱



用途：可快速将 Ø5mmLED的固定于机器面板上，使亮度均

MATERIAL : PC(UL)

FLAME CLASS : 94V-0,94V-2

COLOR : TRANSPARENT

UNIT: mm

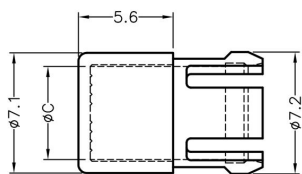

CHASSIS $\phi 6.35$
THICKNESS 3.0

PART NO	C	PACKAGE
LEDLP-117	$\phi 5.2$	1000

LED导光盖 LENS CAP



用途：可快速将Ø5mm的LED固定在机器面板上,使亮度均匀、

MATERIAL : PC(UL)

FLAME CLASS : 94V-0,94V-2

COLOR : TRANSPARENT

UNIT: mm

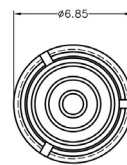
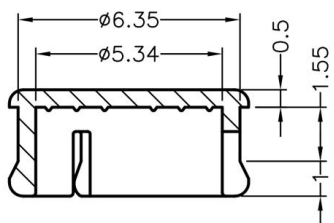

MOUNTING HOLE $\phi 6.35$

PART NO	PACKAGE
LEDLP-118	1000

LED导光盖 LENS CAP



用途：可快速将Ø5mmLED的固定于机器面板上, 使亮度均匀、柔和。

MATERIAL : PC(UL)

FLAME CLASS : 94V-0,94V-2

COLOR : TRANSPARENT

UNIT: mm

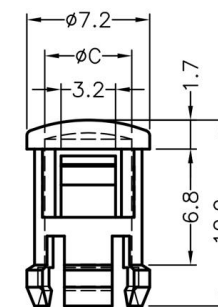

CHASSIS ϕ 6.4
THICKNESS 0.8

PART NO	C	PACKAGE
LEDLP-119	ϕ 5.0	1000

LED导光盖 LENS CAP



用途：可快速将Ø5mmLED的固定于机器面板上, 使亮度均匀、

MATERIAL : PC(UL)

FLAME CLASS : 94V-0,94V-2

COLOR : TRANSPARENT

UNIT: mm

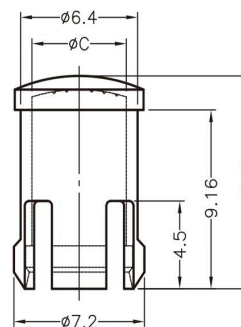

CHASSIS ϕ 6.4~6.45
THICKNESS 0.8~6.35

PART NO	C	PACKAGE
LEDLP-120	ϕ 5.0	1000

LED导光柱 LENS CAP

LED导光柱



用途：可快速将Ø5mmLED的固定于机器面板上, 使亮度均匀、

MATERIAL : PC(UL)
 FLAME CLASS : 94V-0,94V-2
 COLOR : TRANSPARENT
 UNIT: mm

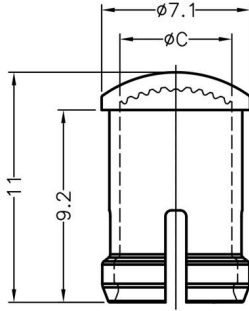

CHASSIS Ø6.4~6.45
 THICKNESS 0.8~6.35

PART NO	C	PACKAGE
LEDLP-121	Ø5.0	1000

LED导光柱 LED LIGHT PIPE



用途：置LED导光于机壳面板上, 使亮度均匀、柔和。

MATERIAL : PC(UL)
 FLAME CLASS : 94V-0,94V-2
 COLOR : TRANSPARENT
 UNIT: mm

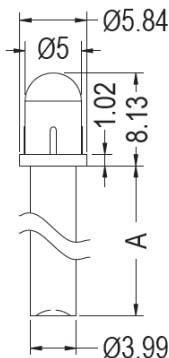

MOUNTING HOLE Ø5.05

PART NO	C	PACKAGE
LEDLP-122	29.3	1000
LEDLP-305	3.2	2000
LEDLP-306	6.4	2000
LEDLP-307	8.9	2000
LEDLP-308	9.5	2000
LEDLP-309	12.7	1000
LEDLP-310	15.9	1000
LEDLP-311	19.0	1000
LEDLP-312	25.4	1000
LEDLP-313	31.8	1000
LEDLP-314	38.1	1000

LED导光柱 LED LIGHT PIPE

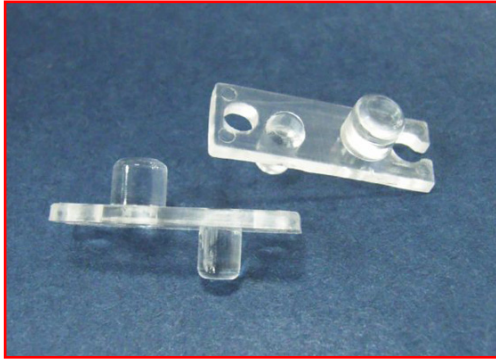

用途：置LED导光于机壳面板上，使亮度均匀、柔和。

MATERIAL : PMMA

COLOR : TRANSPARENT

UNIT: mm

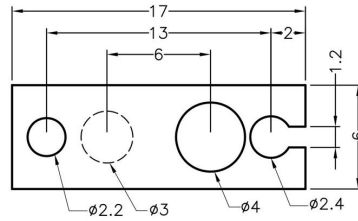
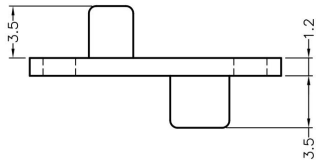

PART NO	PACKAGE
LEDLP-123	1000

LED导光柱

LED导光柱 LED LIGHT PIPE

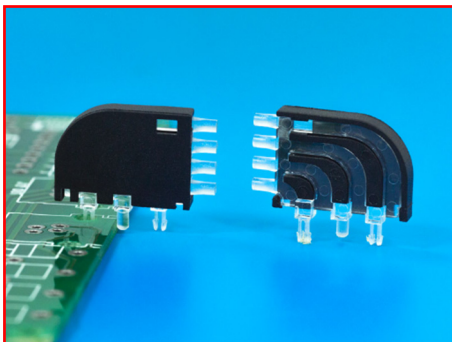

用途：置S.M.T LED导光于机壳面板上，使亮度均匀、柔和。

MATERIAL : PC(UL)

HOLDER MATERIAL: NYLON 66(UL)

FLAME CLASS: 94V-0/94V-2

COLOR:TRANSPAERENT

HOLDER COLOER: BLACK

UNIT:mm

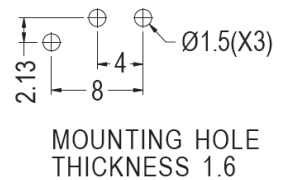
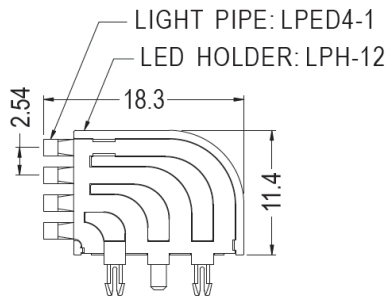
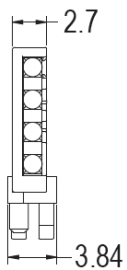

PART NO	PACKAGE
LEDLP-124	1000

LED导光柱 LED LIGHT PIPE

LED导光柱



用途：把LED导光到机壳面板上，使光度均匀、柔和。

MATERIAL : PC(UL)

FLAME CLASS : 94V-0,94V-2

COLOR : TRANSPARENT

UNIT: mm

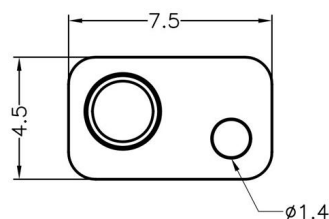
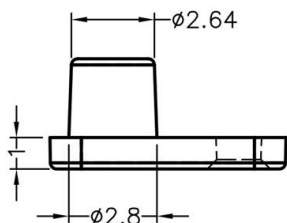

PART NO	PACKAGE
LEDLP-125	1000

LED导光柱 LED LIGHT PIPE



用途：使LED导光于机壳面板上，使光度均匀、柔和。

MATERIAL : PC(UL)

FLAME CLASS : 94V-0,94V-2

COLOR : TRANSPARENT

UNIT: mm

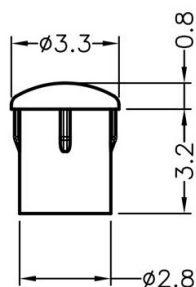

MOUNTING HOLE $\phi 3.0$

PART NO	PACKAGE
LEDLP-133	2000

LED导光柱 LED LIGHT PIPE

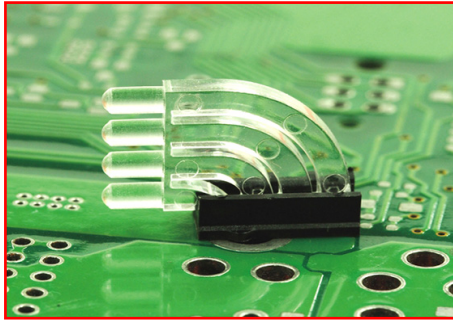

用途： 使S.M.T LED导光于机壳面板上，使光度均匀、柔和。

MATERIAL : PC(UL)

HOLDER MATERIAL : NYLON 66(UL)

FLAME CLASS 1: 94V-0 / 94V-2

COLOR : TRANSPARENT

HOLDER COLOR : BLACK

UNIT: mm

LED导光柱

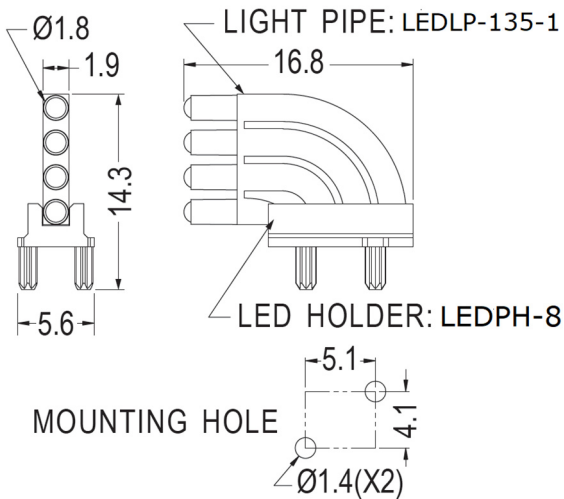

PART NO	PACKAGE
LEDLP-135	1000

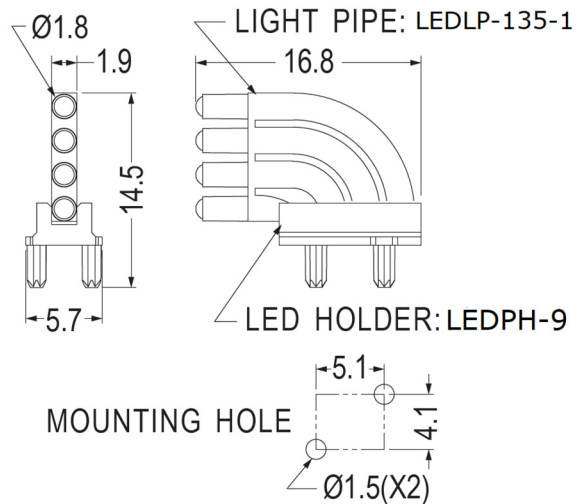

PART NO	PACKAGE
LEDLP-346	1000

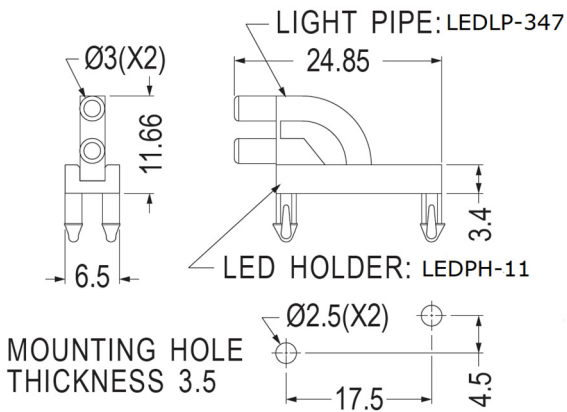

PART NO	PACKAGE
LEDLP-347	1000

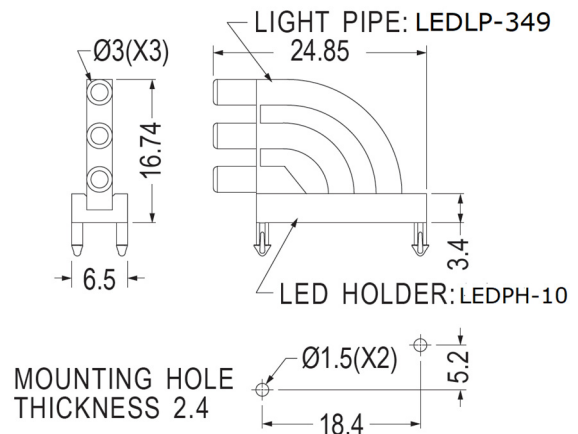

PART NO	PACKAGE
LEDLP-348	1000

LED导光柱 LED LIGHT PIPE

LED导光柱

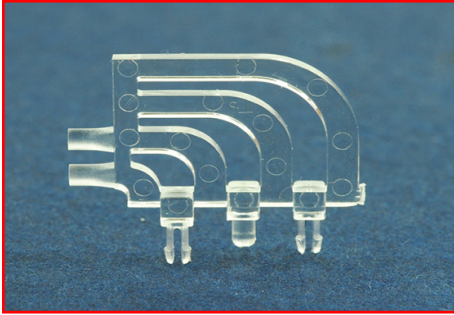

用途：置S.M.T LED导光于机壳面板上，使亮度均匀、柔和。

MATERIAL : PC(UL)

FLAME CLASS : 94V-0

COLOR : TRANSPARENT

UNIT: mm

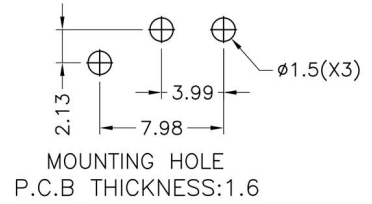
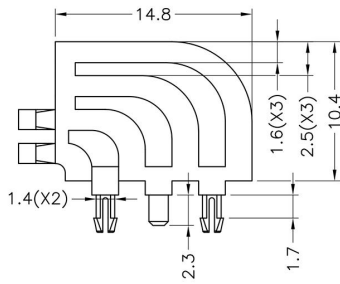
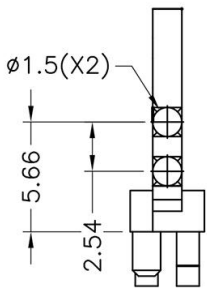

PART NO	PACKAGE
LEDLP-137	1000

LED导光柱 LED LIGHT PIPE



用途：使LED导光于机壳面板上，使光度均匀、柔和。

MATERIAL : PC(UL)

FLAME CLASS : 94V-0,94V-2

COLOR : TRANSPARENT

UNIT: mm

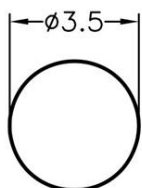
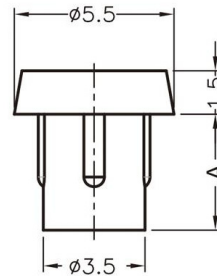
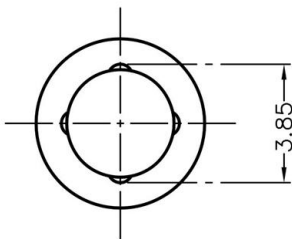

MOUNTING HOLE

PART NO	A	PACKAGE
LEDLP-139	4.0	2000
LEDLP-140	3.0	2000
LEDLP-141	3.5	2000
LEDLP-223	3.45	2000

LED导光柱 LED LIGHT PIPE

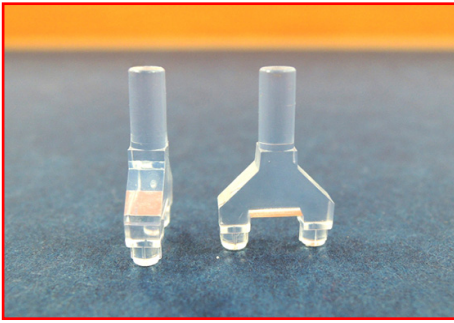

用途：使S.M.T LED导光于机壳面板上，使光度均匀、柔和。

MATERIAL : PC(UL)

FLAME CLASS : 94V-0

COLOR : TRANSPARENT

UNIT: mm

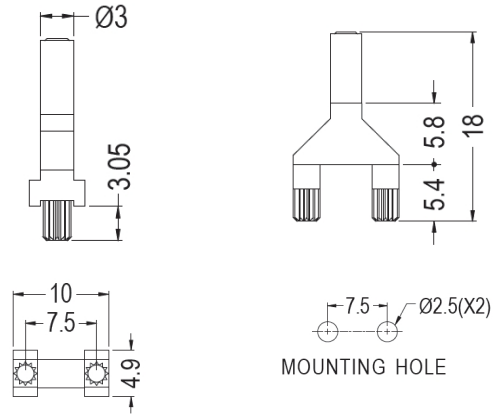
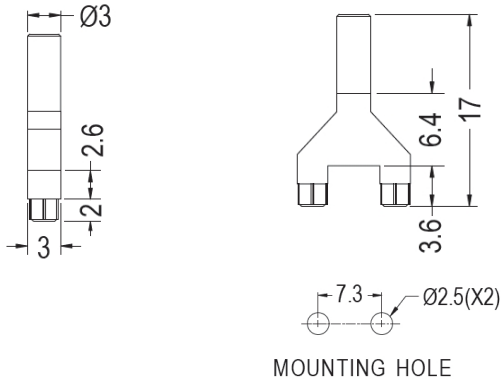

PART NO	PACKAGE
LEDLP-143	2000

PART NO	PACKAGE
LEDLP-315	2000

LED导光柱 LED LIGHT PIPE

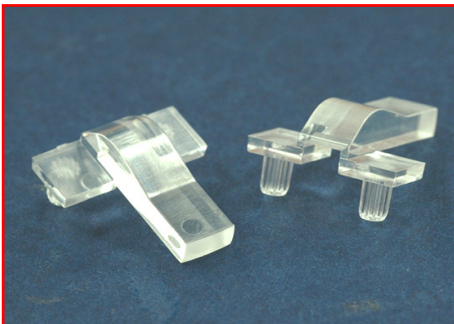

用途：置S.M.T LED导光于机壳面板上，使亮度均匀、柔和。

MATERIAL : PC(UL)

FLAME CLASS : 94V-0/94V-2

COLOR : TRANSPARENT

UNIT: mm

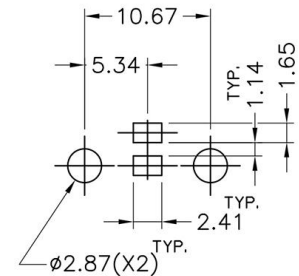
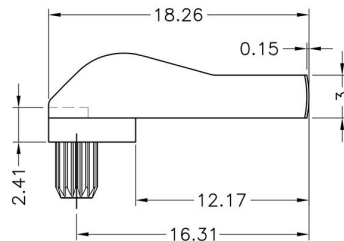
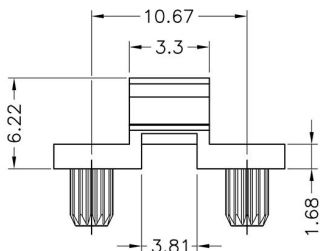

PART NO	PACKAGE
LEDLP-144	1000

LED导光柱 LED LIGHT PIPE

LED导光柱

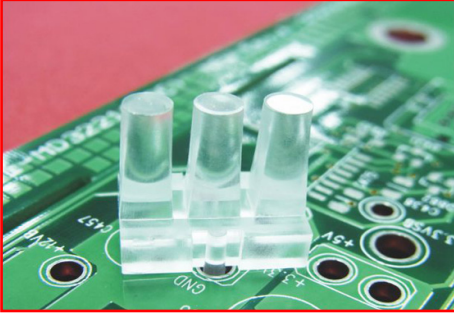

用途：使S.M.T LED导光于机壳面板上，使光度均匀、柔和。

MATERIAL : PC(UL)

FLAME CLASS : 94V-0,94V-2

COLOR : TRANSPARENT

UNIT: mm

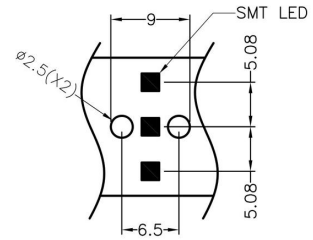
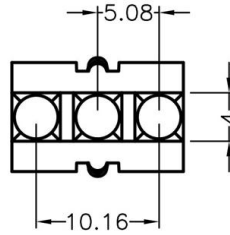
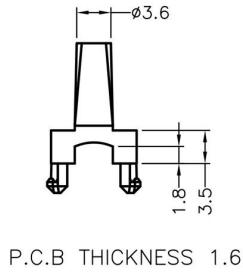
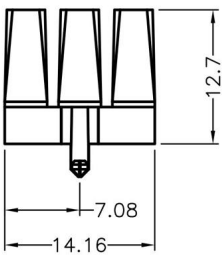

PART NO	PACKAGE
LEDLP-147	500

LED导光柱 LED LIGHT PIPE



用途：使LED导光于机壳面板上，使光度均匀、柔和。

MATERIAL : PC(UL)

FLAME CLASS : 94V-0

COLOR : TRANSPARENT

UNIT: mm

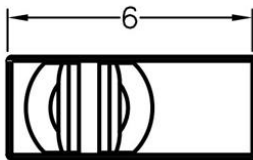

MOUNTING HOLE $\phi 2.6$
THICKNESS 0.9

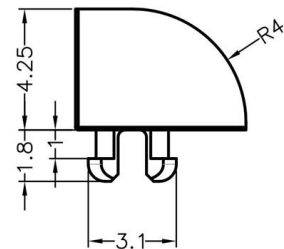
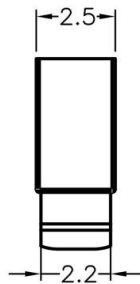

PART NO	PACKAGE
LEDLP-148	1000

LED导光柱 LED PIPE

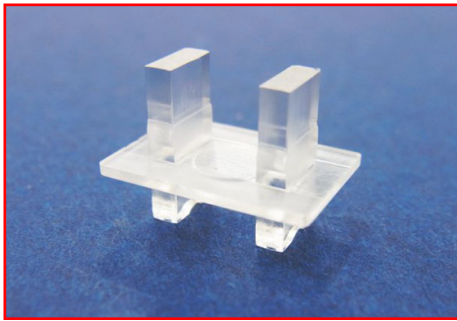

用途：置LED导光于机壳面板上，使亮度均匀、柔和。

MATERIAL : PC(UL)

FLAME CLASS : 94V-0,94V-2

COLOR : TRANSPARENT

UNIT: mm

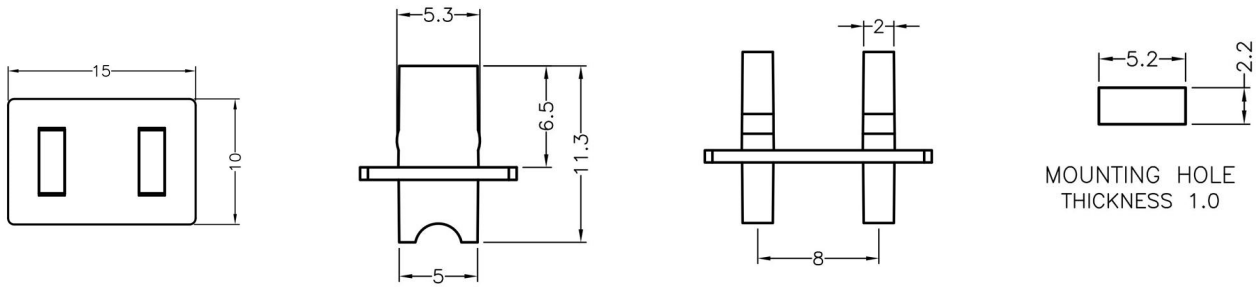

PART NO	PACKAGE
LEDLP-149	500

LED导光柱 LED LIGHT PIPE



用途：用于LED导光。

MATERIAL : PC(UL)

FLAME CLASS : 94V-0

COLOR : TRANSPARENT

UNIT: mm



PART NO	PACKAGE
LEDLP-150	500

LED导光柱

LED导光柱 LED LIGHT PIPE

LED导光柱

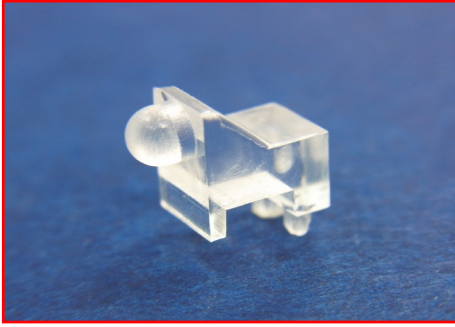

用途：置LED导光于机壳面板上，使亮度均匀、柔和。

MATERIAL : PC(UL)

FLAME CLASS : 94V-0/94V-2

COLOR : TRANSPARENT

UNIT: mm

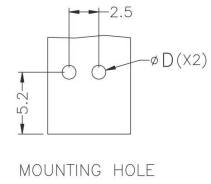
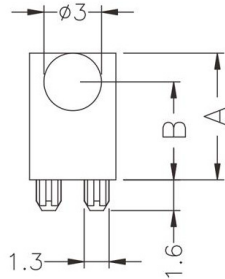
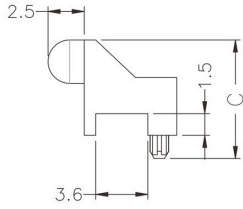

PART NO	A	B	C	D	PACKAGE
LEDLP-151	6.6	5.1	8.2	1.2	2000
LEDLP-224	5.3	3.8	6.9	1.17	2000

LED导光柱 LED LIGHT PIPE

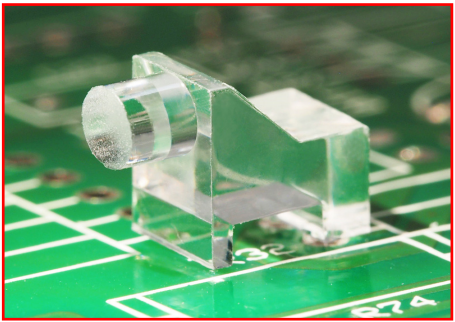

用途：置LED导光于机壳面板上，使亮度均匀、柔和。

MATERIAL : PC(UL)

FLAME CLASS : 94V-0/94V-2

COLOR : TRANSPARENT

UNIT: mm

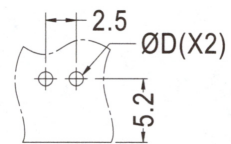
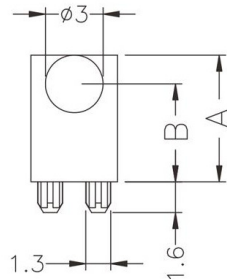
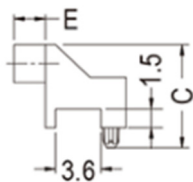

PART NO	A	B	C	D	E	PACKAGE
LEDLP-249	6.6	5.1	8.2	1.2	2.5	2000
LEDLP-250	5.3	3.8	6.9	1.17	2.5	2000
LEDLP-276	5.3	3.8	6.9	1.17	3.8	2000



用途：配合MK005螺帽，使LED导光到面板上，使光线均匀、柔和、防水，方便使用。

MATERIAL : PC(UL)

FLAME CLASS : 94V-0

COLOR : TRANSPARENT

UNIT: mm

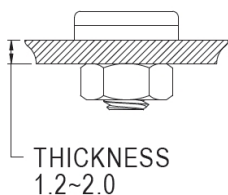

※通过IP68防水测试

此为子母包,内容物包含:

1.LEDLP-152*1000 PACKAGE

2.TF-807*1000 PACKAGE

3.MK005*1000 PACKAGE

以上零件亦可单独选购

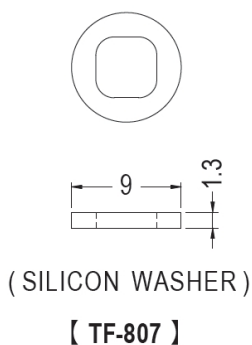
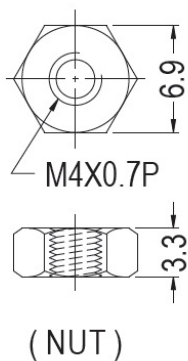

MK005

PART NO	SUB PART NO	PACKAGE
LEDLP-153	LEDLP-152	1000
	TF-807	
	MK005	

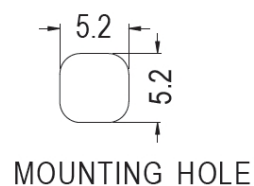
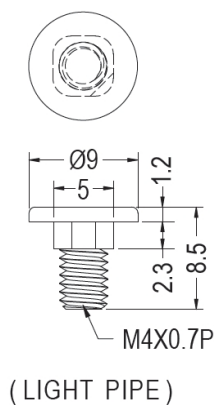

PART NO	PACKAGE
LEDLP-152	1000

LED导光柱 LED LIGHT PIPE

LED导光柱

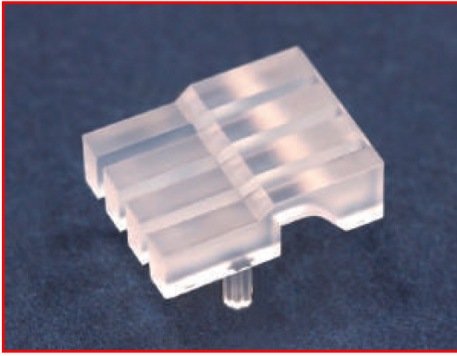

用途：置LED导光到机壳面板上，使亮度均匀、柔和。

MATERIAL : PMMA(UL)/PC(UL)

FLAME CLASS : 94HB/94V-0/94V-2

COLOR: TRANSPARENT

UNIT: mm

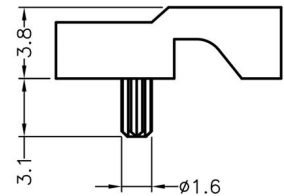
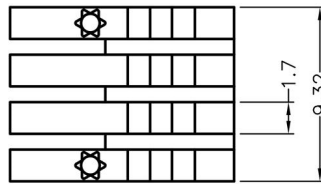
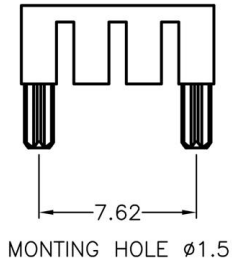

PART NO	PACKAGE
LEDLP-154	2000

LED遮光罩 LENS HOOD

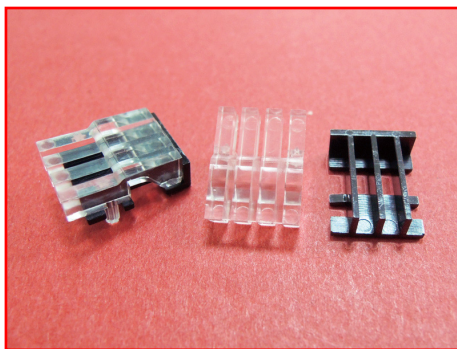

用途：遮光罩,配合LEDLP-154使用。

MATERIAL : PC(UL)

FLAME CLASS : 94V-2

COLOR : BLACK

UNIT: mm

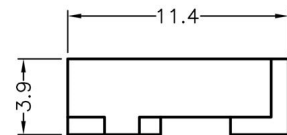
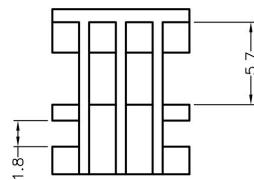
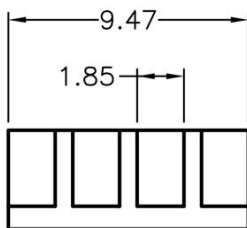

PART NO	PACKAGE
LEDPH-5	2000

PART NO	SUB PART NO	PACKAGE
LEDLP-155	LEDLP-154	2000
	LEDPH-5	

LEDLP-155遮光导光柱, 可免邻近LED光线干扰
导光柱LEDLP-154+LEDPH-5遮光罩组合

LED导光柱 LED LIGHT PIPE



用途：配合光纤将LED光导到机器面板 ,亮面。

MATERIAL : PC(UL)

FLAME CLASS : 94V-0,94V-2

COLOR : TRANSPARENT

UNIT: mm

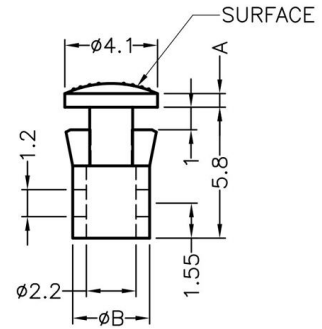

CHASSIS $\phi 3.5$
THICKNESS 0.8~1.0

PART NO	A	B	SURFACE	PACKAGE
LEDLP-156	1.1	3.4	BRIGHT	2000
LEDLP-157	1.05	3.35	MATTE	2000

LED导光柱 LED LIGHT PIPE



用途：配合光纤将LED光导到机器面板 ,亮面。

MATERIAL : PC(UL)

FLAME CLASS : 94V-0,94V-2

COLOR : TRANSPARENT

UNIT: mm

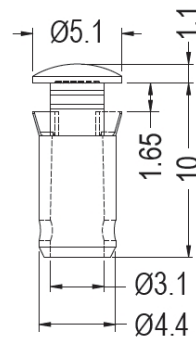

MOUNTING HOLE $\phi 4.5$
THICKNESS 1.6

PART NO	PACKAGE
LEDLP-171	1000

LED导光盖 LENS CAP

LED导光柱



用途：可快速将 $\varnothing 5\text{mm}$ LED固定于机器面板上,使亮度均匀、柔和。

MATERIAL : PC(UL)

FLAME CLASS : 94V-0,94V-2

COLOR : TRANSPARENT

UNIT: mm

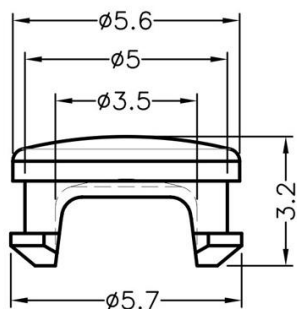

MOUNTING HOLE $\varnothing 5$
THICKNESS 1.3

PART NO	PACKAGE
LEDLP-159	1000

LED导光盖 LENS CAP



用途：使 LED 导光到机壳面板上,使光度均匀、柔和

MATERIAL : PC(UL)

FLAME CLASS : 94V-0,94V-2

COLOR : TRANSPARENT

UNIT: mm

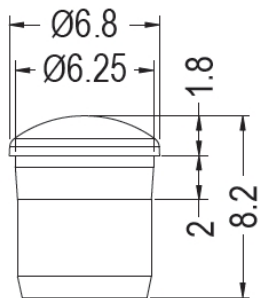

MOUNTING HOLE $\varnothing 6.3$



PART NO	PACKAGE
LEDLP-160	1000

LED导光柱 LED LIGHT PIPE



用途：使S.M.T LED导光到机壳面板上，使光度均匀、柔和。

MATERIAL : PC(UL)
 FLAME CLASS : 94V-0,94V-2
 COLOR : TRANSPARENT
 UNIT: mm

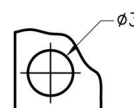
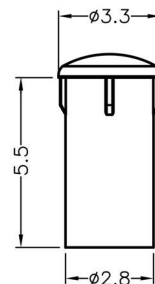

MOUNTING HOLE

PART NO	PACKAGE
LEDLP-161	2000

LED导光柱 LED LIGHT PIPE



用途：使 LED 导光于机壳面板上，使光度均匀、柔和

MATERIAL : PC(UL)
 FLAME CLASS : 94V-0,94V-2
 COLOR : TRANSPARENT
 UNIT: mm

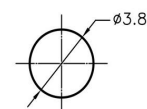
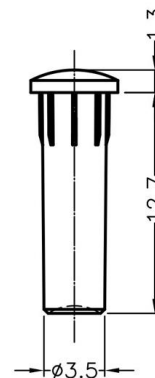

MOUNTING HOLE

PART NO	PACKAGE
LEDLP-162	1000

LED导光柱 LED LIGHT PIPE

LED导光柱

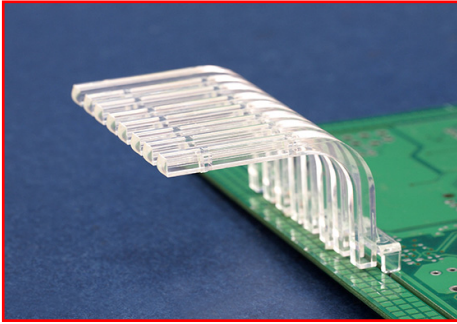

用途：把S.M.T LED导光到机壳面板上，使光度均匀、柔和。

MATERIAL : PC(UL)

FLAME CLASS : 94V-0,94V-2

COLOR : TRANSPARENT

UNIT: mm

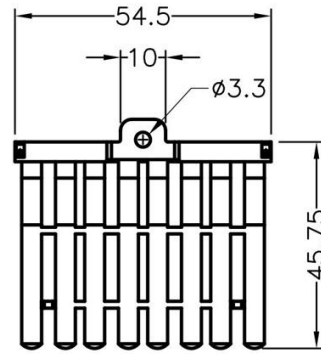
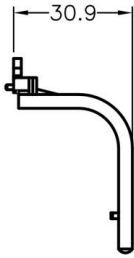

PART NO	PACKAGE
LEDLP-163	50

LED导光柱 LED LIGHT PIPE



用途：将LED导光至机壳面板上，使光度均匀、柔和

MATERIAL : PC(UL)

FLAME CLASS : 94V-0,94V-2

COLOR : TRANSPARENT

UNIT: mm

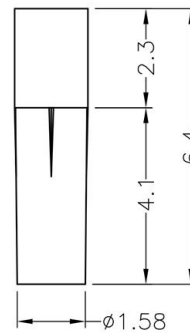
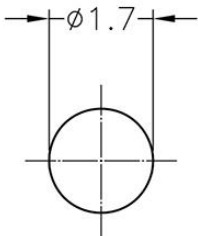

MOUNTING HOLE: $\phi 1.6$

PART NO	PACKAGE
LEDLP-164	2000

LED导光柱 LED LIGHT PIPE

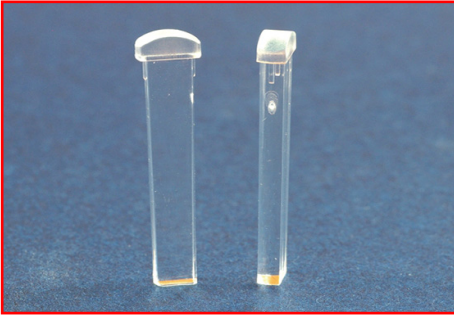

用途：将S.M.T LED导光到机壳面板上，使光度均匀、柔和。

MATERIAL : PC(UL)

FLAME CLASS : 94V-0,94V-2

COLOR : TRANSPARENT

UNIT: mm

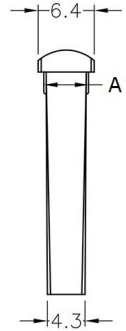
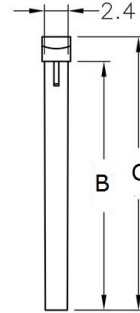
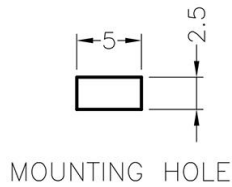
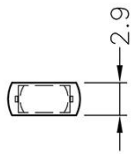

PART NO	A	B	C	PACKAGE
LEDLP-165	5.1	25.4	27.9	1000
LEDLP-260	5.15	17.0	19.5	1000

LED导光柱 LED LIGHT PIPE

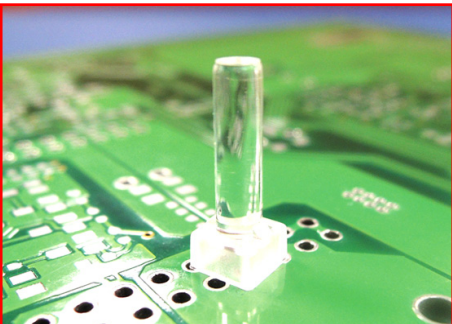

用途：置S.M.T LED导光于机壳面板上，使亮度均匀、柔和。

MATERIAL : PC(UL)

FLAME CLASS : 94V-0,94V-2

COLOR : TRANSPARENT

UNIT: mm

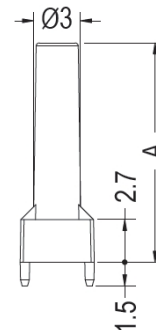
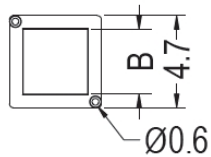

PART NO	A	B	C	PACKAGE
LEDLP-166	13.9	3.3	0.65	1000
LEDLP-251	12.7	3.3	0.65	1000
LEDLP-316	6.4	3.6	0.61	1000

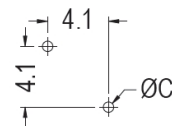

MOUNTING HOLE THICKNESS 1.6

LED导光柱 LED LIGHT PIPE

LED导光柱

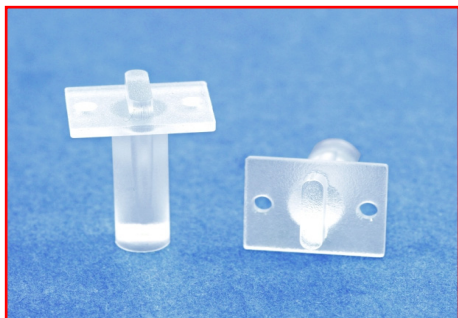

用途：置LED导光于机壳面板上，使亮度均匀、柔和。

MATERIAL : PC(UL)
 FLAME CLASS : 94V-0,94V-2
 COLOR : TRANSPARENT
 UNIT: mm

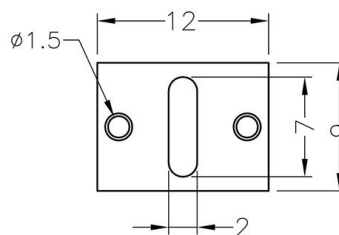
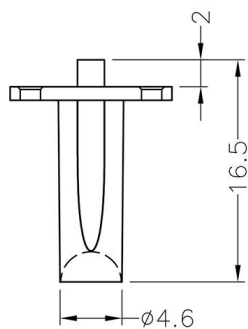

PART NO	PACKAGE
LEDLP-167	1000

LED导光盖 LENS CAP



用途：将LED导光于机壳面板上，使亮度均匀、柔和。

MATERIAL : PC(UL)
 FLAME CLASS : 94V-0,94V-2
 COLOR : TRANSPARENT
 UNIT: mm

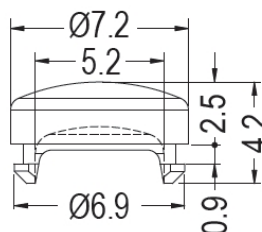

MOUNTING HOLE $\varnothing 6.35$
 THICKNESS 0.8

PART NO	PACKAGE
LEDLP-158	1000

LED导光柱 LED LIGHT PIPE

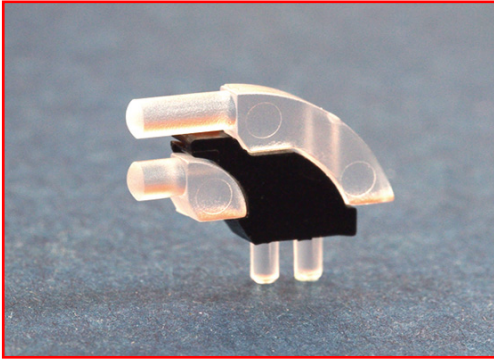

用途：置LED导光到机壳面板上，使亮度均匀、柔和。
LEDPH-2遮光罩，可免邻近LED光线干扰，配合LEDLP-172组合使用。

PART NO	SUB PART NO	PACKAGE
LEDLP-173	LEDLP-172	1000
	LEDPH-2	

LED导光柱

LED导光柱 LED LIGHT PIPE

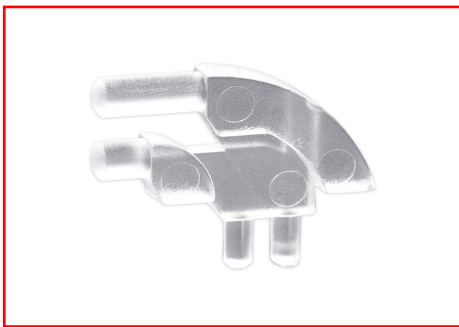

用途：将LED导光到机壳面板上，使光度均匀、柔和。

MATERIAL : PC(UL)
FLAME CLASS : 94V-0,94V-2
COLOR : TRANSPARENT
UNIT: mm

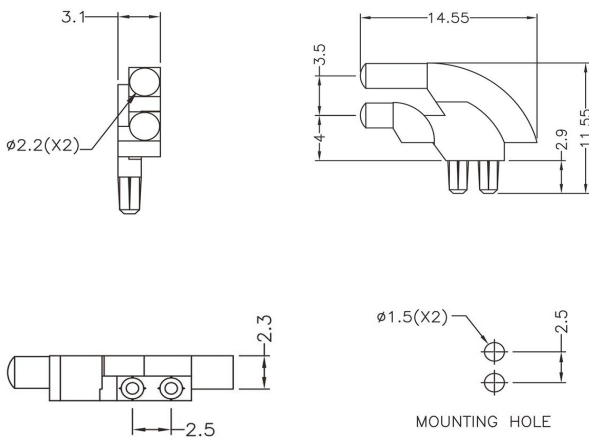

PART NO	PACKAGE
LEDLP-172	1000

LED遮光罩 LIGHT PIPE MASK



用途：导光柱遮光罩，可免邻近LED光线干扰，配合LEDLP-172使用。

MATERIAL : NYLON 66(UL)
FLAME CLASS : 94V-0,94V-2
COLOR : BLACK
UNIT: mm

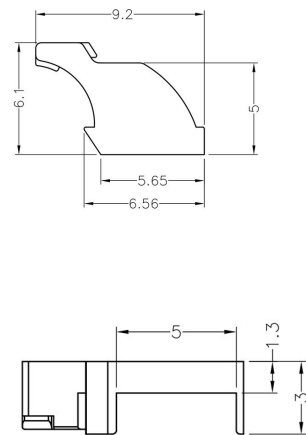

PART NO	PACKAGE
LEDPH-2	1000

LED导光柱 LED LIGHT PIPE

LED导光柱

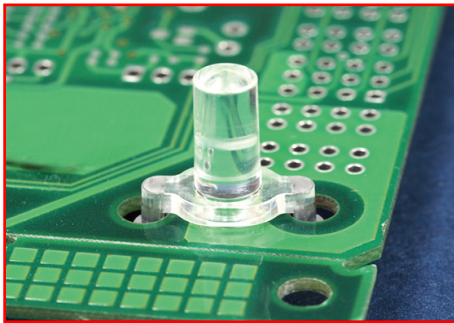

用途：使LED导光于机壳面板上，使光度均匀、柔和。

MATERIAL : PC(UL)

FLAME CLASS : 94V-0,94V-2

COLOR : TRANSPARENT

UNIT: mm

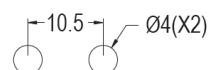
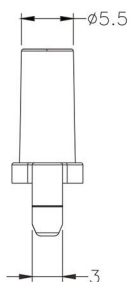
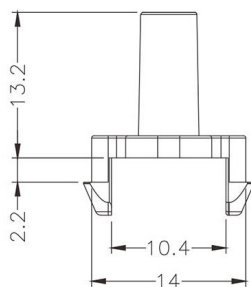

MOUNTING HOLE

PART NO	PACKAGE
LEDLP-174	1000

LED导光柱 LED LIGHT PIPE



用途：使LED导光于机壳面板上，使光度均匀、柔和。

MATERIAL : PC(UL)

FLAME CLASS : 94V-0,94V-2

COLOR : TRANSPARENT

UNIT: mm

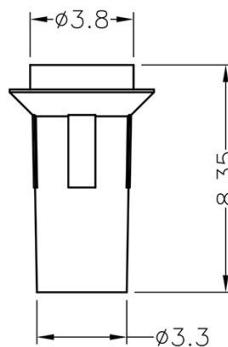
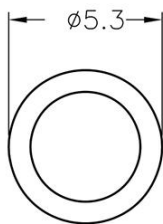

MOUNTING HOLE $\phi 3.5$

PART NO	PACKAGE
LEDLP-175	1000

LED导光柱 LED LIGHT PIPE



用途：使LED导光于机壳面板上，使光度均匀、柔和。

MATERIAL : PMMA
 COLOR : TRANSPARENT
 UNIT: mm

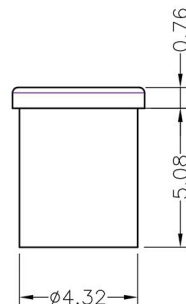
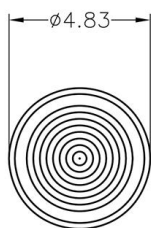

PART NO	PACKAGE
LEDLP-176	1000

LED导光柱 LED LIGHT PIPE



用途：使LED导光于机壳面板上，使光度均匀、柔和。

MATERIAL : PC
 COLOR : TRANSPARENT
 UNIT: mm

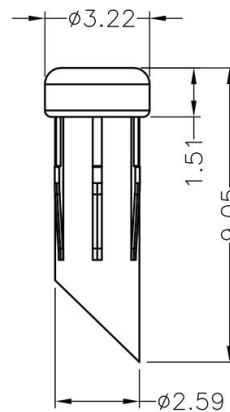

PART NO	PACKAGE
LEDLP-177	2000

LED导光柱 LED LIGHT PIPE

LED导光柱



用途：使LED导光于机壳面板上，使光度均匀、柔和。

MATERIAL : PC(UL)
 FLAME CLASS : 94V-0,94V-2
 COLOR : TRANSPARENT
 UNIT: mm

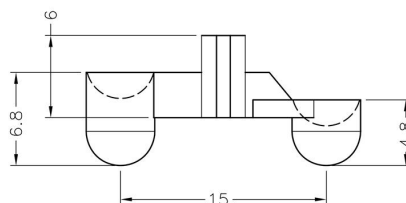
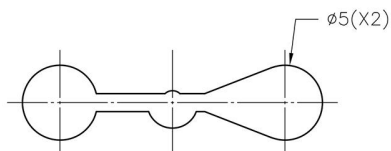

PART NO	PACKAGE
LEDLP-178	1000

LED导光柱 LED LIGHT PIPE



用途：使LED导光于机壳面板上，使光度均匀、柔和。

MATERIAL : PC(UL)
 FLAME CLASS : 94V-0,94V-2
 COLOR : TRANSPARENT
 UNIT: mm

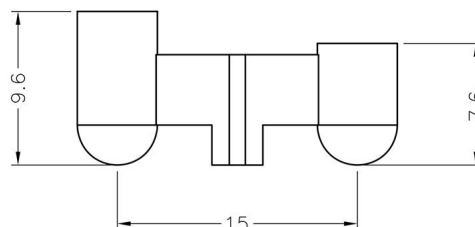
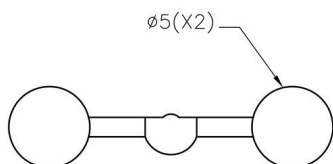

PART NO	PACKAGE
LEDLP-179	1000

LED导光柱 LED LIGHT PIPE



用途：使LED导光于机壳面板上，使光度均匀、柔和。

MATERIAL : PC

FLAME CLASS : 94V-0,94V-2

COLOR : TRANSPARENT

UNIT: mm

LED导光柱

PART NO	L	PACKAGE
LEDLP-180	10.0	2000
LEDLP-181	2.5	2000
LEDLP-182	3.0	2000
LEDLP-183	3.2	2000
LEDLP-184	5.0	2000
LEDLP-185	6.0	2000
LEDLP-186	8.0	2000
LEDLP-225	12.7	2000
LEDLP-252	9.5	2000

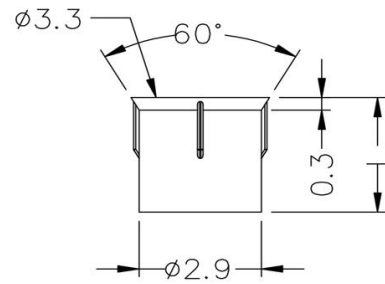

MOUNTING HOLE $\phi 3.07\text{mm}$

LED导光柱 LED LIGHT PIPE



用途：使LED导光于机壳面板上，使光度均匀、柔和。

MATERIAL : PC

COLOR : TRANSPARENT

UNIT: mm

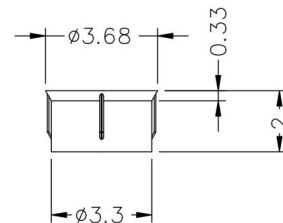

MOUNTING HOLE $\phi 3.5$

PART NO	PACKAGE
LEDLP-187	2000

LED导光柱 LED LIGHT PIPE

LED导光柱



用途：使LED导光于机壳面板上，使光度均匀、柔和。

MATERIAL : PC

FLAME CLASS : 94V-0,94V-2

COLOR : TRANSPARENT

UNIT: mm

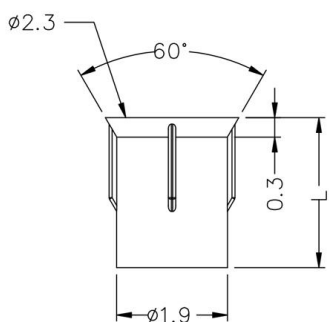

MOUNTING HOLE $\phi 1.98\text{mm}$

PART NO	L	PACKAGE
LEDLP-188	2.5	2000
LEDLP-189	4.8	2000
LEDLP-190	7.0	2000
LEDLP-191	8.0	2000
LEDLP-192	10.0	2000
LEDLP-230	3.2	2000
LEDLP-231	9.0	2000
LEDLP-253	4.0	2000
LEDLP-277	2.0	2000
LEDLP-278	3.0	2000
LEDLP-279	6.40	2000
LEDLP-326	5.0	2000
LEDLP-350	20.0	2000

LED导光柱 LED PIPE



用途：使LED导光于机壳面板上，使光度均匀、柔和。

MATERIAL : PC

FLAME CLASS : 94V-0

COLOR : TRANSPARENT

UNIT: mm

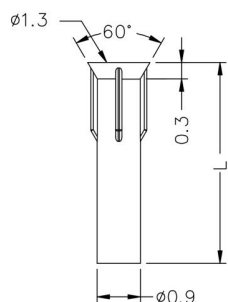

MOUNTING HOLE $\phi 1.02$

PART NO	L	PACKAGE
LEDLP-193	2.5	2000
LEDLP-194	5.0	2000
LEDLP-195	12.7	2000
LEDLP-232	3.0	2000
LEDLP-254	4.8	2000
LEDLP-327	4.0	2000
LEDLP-328	6.0	2000
LEDLP-329	13.7	2000
LEDLP-351	10.0	2000

LED导光柱 LED LIGHT PIPE



用途：使LED导光于机壳面板上，使光度均匀、柔和。

MATERIAL : PC

COLOR : TRANSPARENT

UNIT: mm

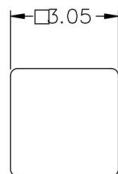
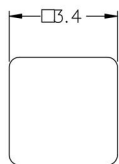

MOUNTING HOLE

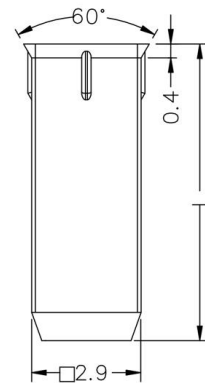

PART NO	L	PACKAGE
LEDLP-196	3.0	2000
LEDLP-197	8.0	2000

LED导光柱 LED LIGHT PIPE



用途：使LED导光于机壳面板上，使光度均匀、柔和。

MATERIAL : PC

COLOR : TRANSPARENT

UNIT: mm



MOUNTING HOLE

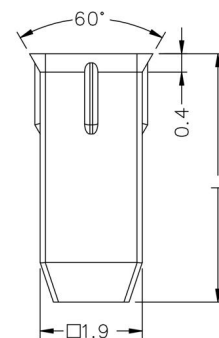

PART NO	L	PACKAGE
LEDLP-198	3.0	2000
LEDLP-199	4.8	2000
LEDLP-330	2.5	2000
LEDLP-331	10.0	2000

LED导光柱 LED LIGHT PIPE

LED导光柱

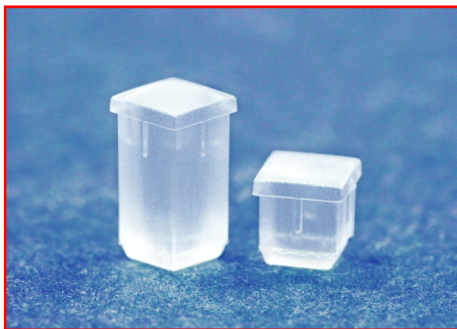

用途：使LED导光于机壳面板上，使光度均匀、柔和。

MATERIAL : PC

COLOR : TRANSPARENT

UNIT: mm

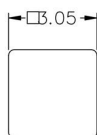
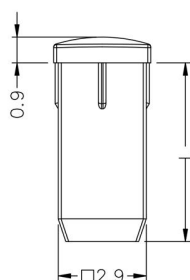
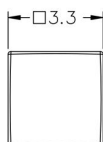

MOUNTING HOLE

PART NO	L	PACKAGE
LEDLP-200	3.0	2000
LEDLP-201	6.0	2000
LEDLP-202	7.0	2000
LEDLP-255	5.0	2000
LEDLP-332	2.5	2000

LED导光柱 LED LIGHT PIPE

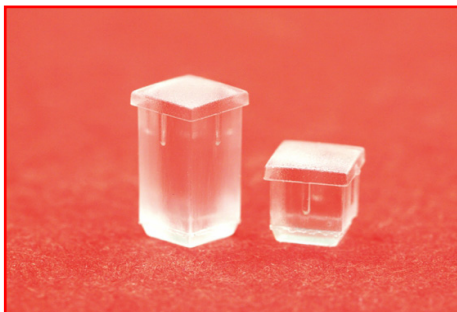

用途：使LED导光于机壳面板上，使光度均匀、柔和。

MATERIAL : PC

COLOR : TRANSPARENT

UNIT: mm

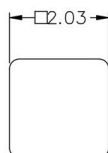
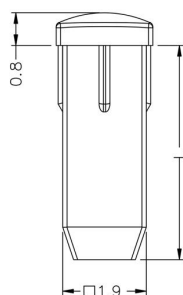
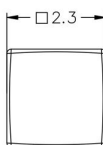

MOUNTING HOLE

PART NO	L	PACKAGE
LEDLP-203	3.0	2000
LEDLP-204	5.0	2000
LEDLP-233	12.7	2000
LEDLP-256	4.8	2000
LEDLP-257	9.0	2000

LED导光柱 LED LIGHT PIPE



用途：使LED导光于机壳面板上，使光度均匀、柔和。

MATERIAL : PC(UL)
 FLAME CLASS : 94V-0,94V-2
 COLOR : TRANSPARENT
 UNIT: mm

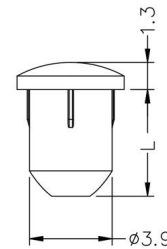
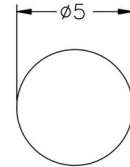

MOUNTING HOLE ϕ 3.96

PART NO	L	PACKAGE
LEDLP-205	5.0	2000
LEDLP-206	6.0	2000
LEDLP-207	8.0	2000
LEDLP-234	10.0	2000
LEDLP-258	12.7	2000
LEDLP-259	4.0	2000
LEDLP-280	3.2	2000

LED导光柱 LED LIGHT PIPE



用途：使LED导光于机壳面板上，使光度均匀、柔和。

MATERIAL : PC(UL)
 FLAME CLASS : 94V-0,94V-2
 COLOR : TRANSPARENT
 UNIT: mm

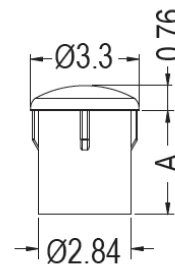

MOUNTING HOLE: ϕ G

PART NO	A	G	PACKAGE
LEDLP-208	4.0	3.05	2000
LEDLP-209	6.0	3.0	2000
LEDLP-210	8.0	3.05	2000
LEDLP-211	25.4	3.05	1000
LEDLP-235	10.0	3.0	2000
LEDLP-236	30.5	3.0	1000
LEDLP-264	5.0	3.0	2000
LEDLP-265	7.0	3.0	2000
LEDLP-333	3.2	3.0	2000
LEDLP-334	4.8	3.0	2000
LEDLP-335	9.5	3.0	2000

PART NO	A	G	PACKAGE
LEDLP-352	2.5	3.0	2000
LEDLP-353	5.5	3.0	2000
LEDLP-354	6.4	3.0	2000
LEDLP-355	8.9	3.0	2000
LEDLP-356	12.7	3.0	2000
LEDLP-357	15.9	3.0	2000
LEDLP-358	19.0	3.0	2000
LEDLP-359	24.0	3.0	1000

LED导光柱 LED LIGHT PIPE

LED导光柱



用途：使LED导光于机壳面板上，使光度均匀、柔和。

MATERIAL : PC(UL)

FLAME CLASS : 94V-0,94V-2

COLOR : TRANSPARENT

UNIT: mm

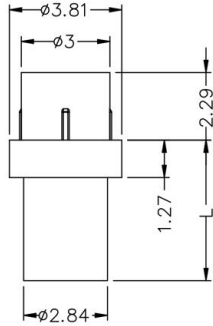

MOUNTING HOLE ϕ 3.05

PART NO	L	PACKAGE
LEDLP-212	4.8	2000
LEDLP-213	5.0	2000
LEDLP-214	8.0	2000

PART NO	L	PACKAGE
LEDLP-237	10.0	2000
LEDLP-238	7.0	2000
LEDLP-242	2.5	2000
LEDLP-243	3.2	2000
LEDLP-296	6.4	2000
LEDLP-320	8.9	2000
LEDLP-321	9.5	2000
LEDLP-322	12.7	1000
LEDLP-323	15.9	1000
LEDLP-324	19.0	1000
LEDLP-325	21.1	1000

LED导光柱 LED LIGHT PIPE



用途：使LED导光于机壳面板上，使光度均匀、柔和。

MATERIAL : PC(UL)

FLAME CLASS : 94V-0

COLOR : TRANSPARENT

UNIT: mm

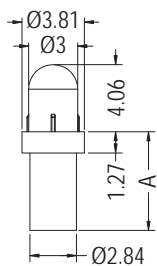

MOUNTING HOLE ϕ 3.0

PART NO	L	PACKAGE
LEDLP-215	6.0	2000
LEDLP-317	3.2	2000
LEDLP-318	6.4	2000
LEDLP-319	8.9	2000
LEDLP-336	9.5	1000
LEDLP-337	11.68	1000
LEDLP-338	12.7	1000
LEDLP-339	15.9	1000
LEDLP-340	19.0	1000
LEDLP-341	21.0	1000

LED导光盖 LENS CAP



用途：使LED导光于机壳面板上，使光度均匀、柔和。

MATERIAL : PC(UL)
 FLAME CLASS : 94V-0,94V-2
 COLOR : TRANSPARENT/
 UNIT: mm

LED导光柱

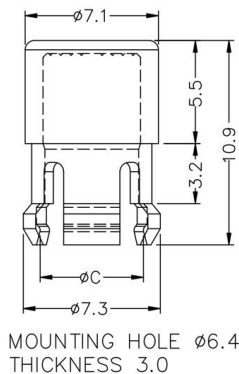

PART NO	C	PACKAGE
LEDLP-216	5.0	1000

LED导光柱 LED LIGHT PIPE



用途：使LED导光于机壳面板上，使光度均匀、柔和。

MATERIAL : PC(UL)
 FLAME CLASS : 94V-0
 COLOR : TRANSPARENT
 UNIT: mm

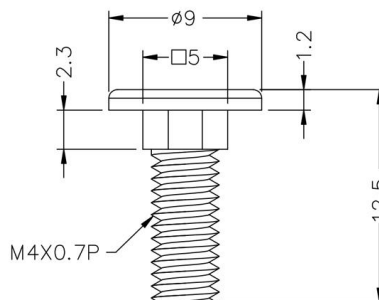
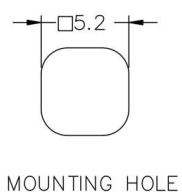

PART NO	PACKAGE
LEDLP-217	1000

LED导光柱 LED LIGHT PIPE

LED导光柱

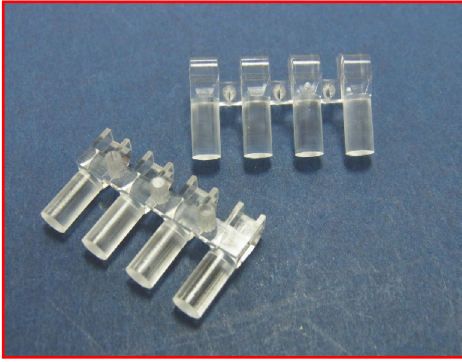

用途：使LED导光于机壳面板上，使光度均匀、柔和。

MATERIAL : PC(UL)

FLAME CLASS : 94V-0,94V-2

COLOR : TRANSPARENT

UNIT: mm

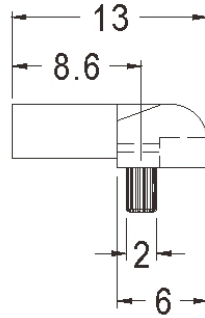
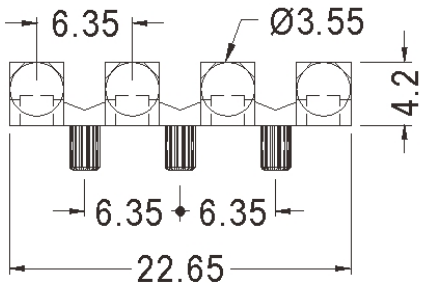

PART NO	PACKAGE
LEDLP-218	1000

LED导光柱 LED LIGHT PIPE

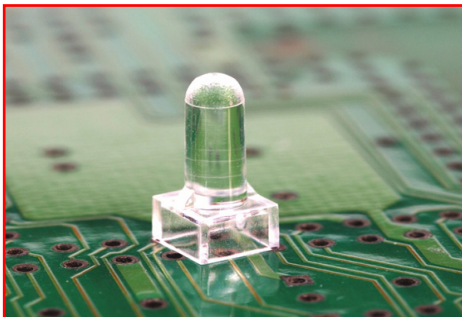

用途：使LED导光于机壳面板上，使光度均匀、柔和。

MATERIAL : PC(UL)

FLAME CLASS : 94V-0

COLOR : TRANSPARENT

UNIT: mm

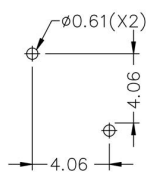
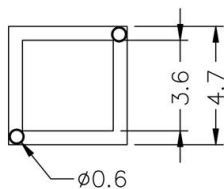
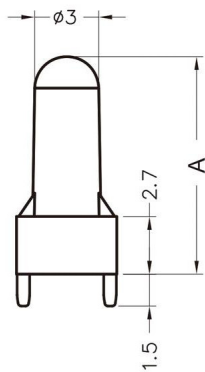

MOUNTING HOLES

PART NO	A	PACKAGE
LEDLP-226	7.6	1000
LEDLP-266	10.2	1000
LEDLP-227	11.4	1000
LEDLP-228	12.7	1000
LEDLP-229	16.5	1000
LEDLP-281	5.1	1000
LEDLP-282	8.9	1000
LEDLP-283	21.5	1000
LEDLP-360	13.9	1000

LED导光柱 LED LIGHT PIPE



用途：使LED导光于机壳面板上，使光度均匀、柔和。

MATERIAL : PC(UL)

FLAME CLASS : 94V-0,94V-2

COLOR : TRANSPARENT

UNIT: mm

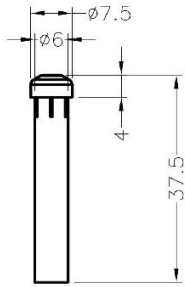

MOUNTING HOLE ϕ 6.5mm

PART NO	PACKAGE
LEDLP-240	500

LED导光柱 LED LIGHT PIPE

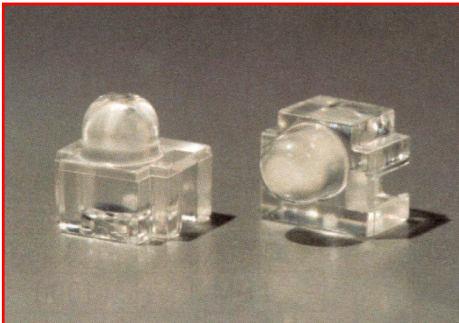

用途：置LED导光于机壳面板上，使亮度均匀、柔和。

MATERIAL : PC(UL)

FLAME CLASS : 94V-0,94V-2

COLOR : TRANSPARENT

UNIT: mm

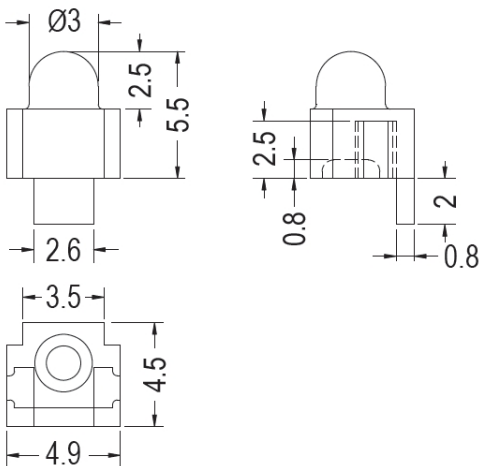

PART NO	PACKAGE
LEDLP-247	2000

LED导光盖 LENS CAP

LED导光柱

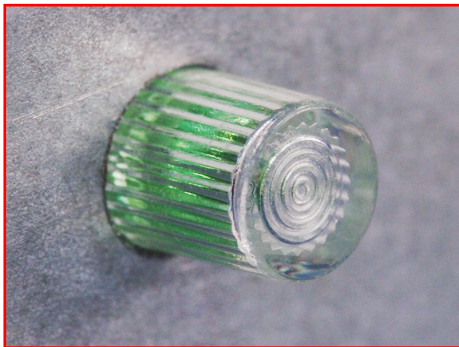

用途：使LED导光于机壳面板上，使光度均匀、柔和。搭配

MATERIAL : PC(UL)

FLAME CLASS : 94V-0,94V-2

COLOR : TRANSPARENT

UNIT: mm

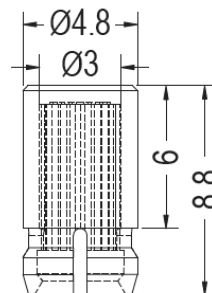

CHASSIS Ø4.4
THICKNESS 0.7

PART NO	PACKAGE
LEDLP-275	2000

LED导光柱 LED LIGHT PIPE

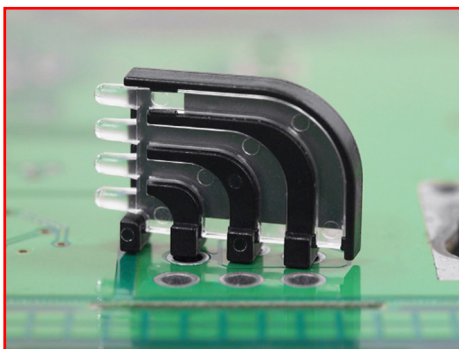

用途：置S.M.T LED导光于机壳面板上，使亮度均匀、柔和。

MATERIAL : PC(UL)

HOLDER MATERIAL: NYLON 66(UL)

FLAME CLASS : 94V-0,94V-2

COLOR : TRANSPARENT

UNIT: mm

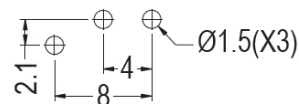
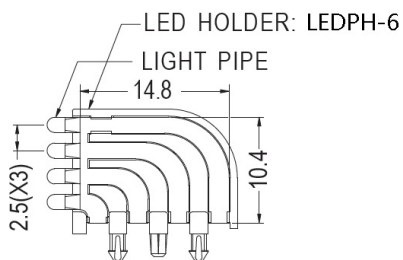
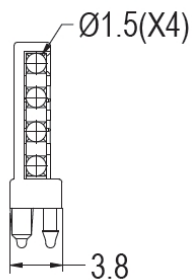

MOUNTING HOLE
P.C.B THICKNESS 1.6

PART NO	PACKAGE
LEDLP-297	1000

LED导光柱 LED PIPE



用途：使LED导光于机壳面板上，使光度均匀、柔和。

MATERIAL : PC(UL)

FLAME CLASS : 94V-0,94V-2

COLOR : TRANSPARENT

UNIT: mm

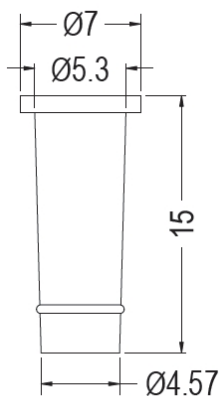

PART NO	PACKAGE
LEDLP-261	1000

LED导光柱

LED导光柱 LED LIGHT PIPE

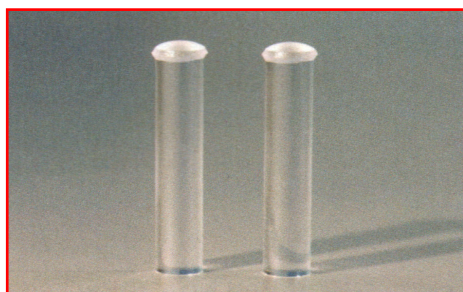

用途：使LED导光于机壳面板上，使光度均匀、柔和。

MATERIAL : PC(UL)

FLAME CLASS : 94V-0,94V-2

COLOR : TRANSPARENT

UNIT: mm

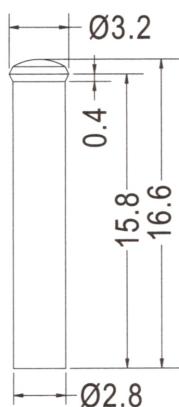

PART NO	PACKAGE
LEDLP-262	1000

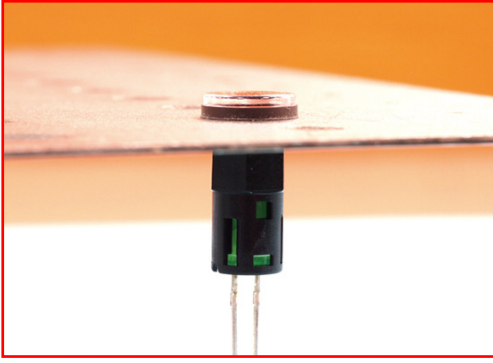

用途：可快速将LED固定于机器面板上，防水性佳。

MATERIAL NYLON 66(UL)

FLAME CLASS : 94V-0,94V-2

COLOR : BLACK,NATURAL

UNIT: mm

经过IP68防水测试

此为子母包,内容物包含:

LEDLP-152*1000 PACKAGE

LEDZ-77 *1000 PACKAGE

TF-807 *1000 PACKAGE

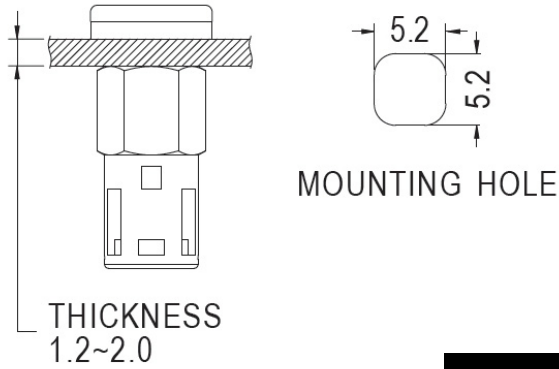

PART NO	SUB PART NO	PACKAGE
LEDLP-267	LEDLP-152	1000
	TF-807	
	LEDZ-77	

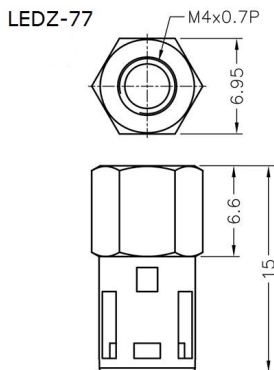
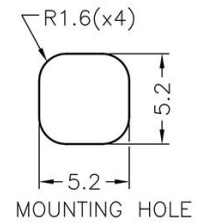

TF-807

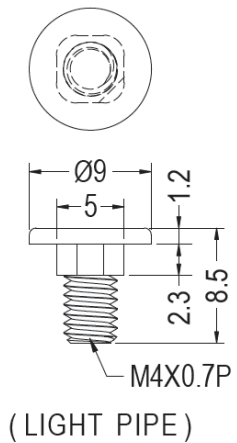
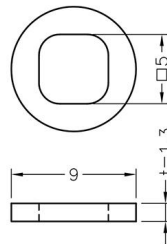

PART NO	PACKAGE
LEDZ-77	2000

PART NO	PACKAGE
TF-807	2000

PART NO	PACKAGE
LEDLP-152	2000

LED导光柱 LED LIGHT PIPE

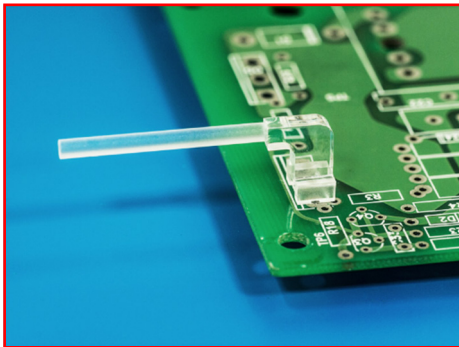

用途：置S.M.T LED导光于机壳面板上，使亮度均匀、柔和。

MATERIAL : PC(UL)

FLAME CLASS : 94V-0,94V-2

COLOR : TRANSPARENT

UNIT: mm

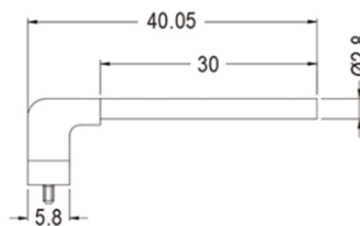
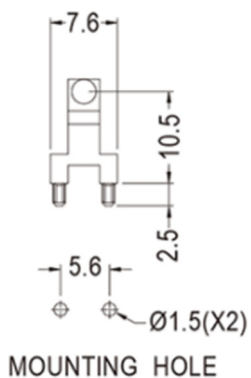

PART NO	PACKAGE
LEDLP-272	1000

LED导光柱

LED导光柱 LED LIGHT PIPE



用途：置LED导光于机壳面板上，使亮度均匀、柔和。

MATERIAL : PC(UL)

FLAME CLASS : 94V-0,94V-2

COLOR : TRANSPARENT

UNIT: mm

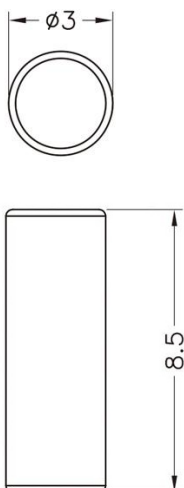

PART NO	PACKAGE
LEDLP-111	2000

LED导光柱 LED LIGHT PIPE

LED导光柱



用途：置S.M.T LED导光于机壳面板上，使亮度均匀、柔和。

MATERIAL : PC(UL)

FLAME CLASS : 94V-0,94V-2

COLOR : TRANSPARENT

UNIT: mm

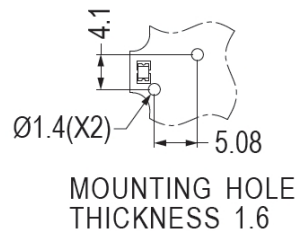
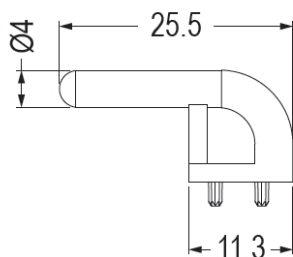
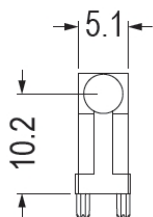

PART NO	PACKAGE
LEDLP-299	1000

LED导光柱 LED LIGHT PIPE



用途：置LED导光于机壳面板上，使亮度均匀、柔和。

MATERIAL : PC(UL)

FLAME CLASS : 94V-0,94V-2

COLOR : TRANSPARENT

UNIT: mm

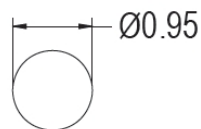

PART NO	PACKAGE
LEDLP-298	1000

LED导光柱 LED LIGHT PIPE



用途：置LED导光于机壳面板上，使亮度均匀、柔和。

MATERIAL : PC(UL)

FLAME CLASS : 94V-0,94V-2

COLOR : TRANSPARENT

UNIT: mm

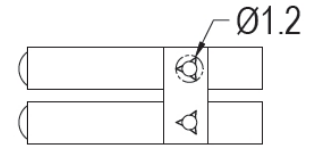
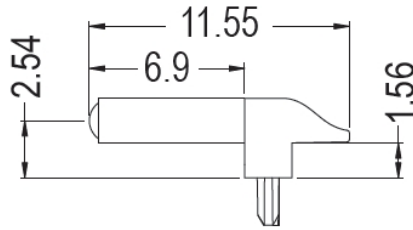
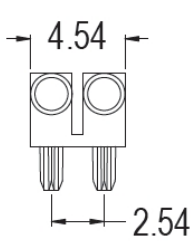

MOUNTING HOLE 1.1

PART NO	PACKAGE
LEDLP-300	1000

LED导光柱 LED LIGHT PIPE



用途：置LED导光于机壳面板上，使亮度均匀、柔和。

MATERIAL : PC(UL)

FLAME CLASS : 94V-0,94V-2

COLOR : TRANSPARENT

UNIT: mm

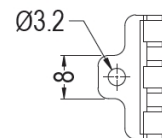
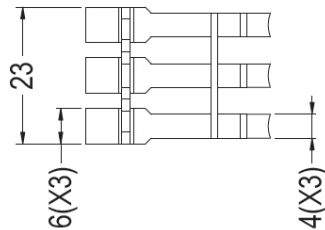
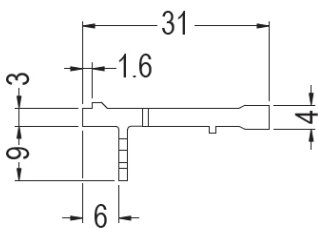

PART NO	PACKAGE
LEDLP-301	1000

LED导光柱 LED LIGHT PIPE

LED导光柱



用途：置LED导光于机壳面板上，使亮度均匀、柔和。

MATERIAL : PC(UL)

FLAME CLASS : 94V-0,94V-2

COLOR : TRANSPARENT

UNIT: mm

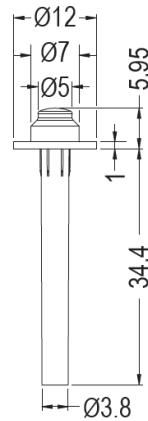

MOUNTING HOLE Ø4.3

PART NO	PACKAGE
LEDLP-302	500

LED灯罩 LED COVER

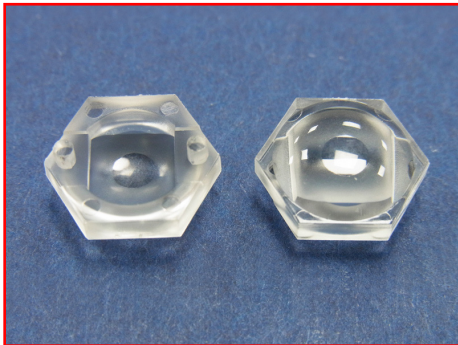

用途：用于LED导光，使亮度均匀、柔和。

MATERIAL : PC(UL)

FLAME CLASS : 94V-0,94V-2

COLOR : TRANSPARENT

UNIT: mm

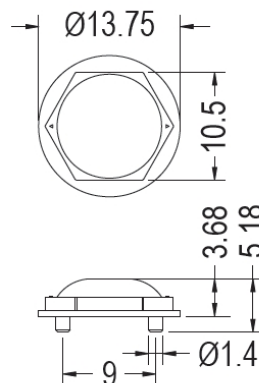

PART NO	PACKAGE
LEDLP-342	1000

LED导光柱 LED LIGHT PIPE

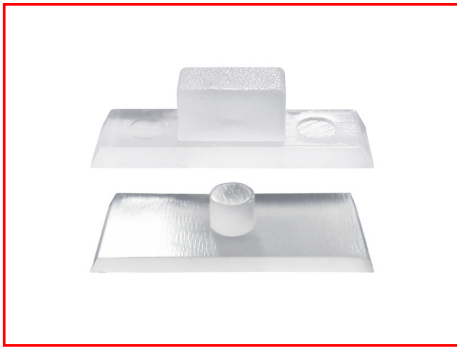

用途：置LED导光于机壳面板上，使亮度均匀、柔和。

MATERIAL : PC(UL)

COLOR : TRANSPARENT

UNIT: mm

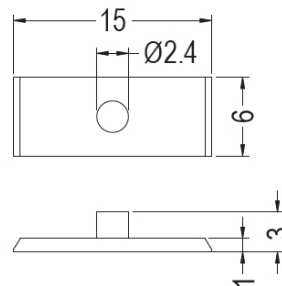
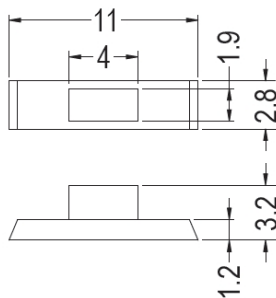

PART NO	PACKAGE
LEDLP-343	1000

PART NO	PACKAGE
LEDLP-345	1000

LED导光柱 LED LIGHT PIPE



用途：置LED导光于机壳面板上，使亮度均匀、柔和。

MATERIAL : PMMA

COLOR : TRANSPARENT

UNIT: mm

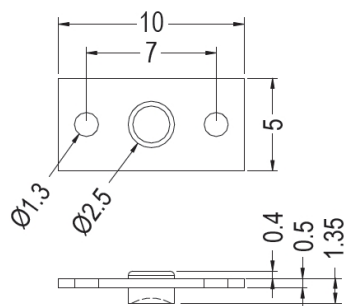

PART NO	PACKAGE
LEDLP-344	1000

LED导光座 LED LIGHT GUIDE HOLDER

LED导光柱

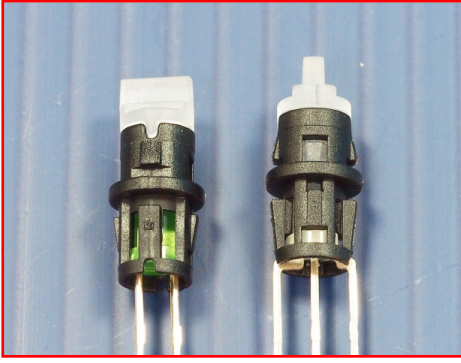

用途：可快速将LED固定于机器面板上，使LED导光于机壳面板上，使亮度均匀、柔和。

MATERIAL : NYLON 66(UL)/PC(UL)

FLAME CLASS : 94V-0,94V-2

COLOR : BLACK,TRANSPARENT

UNIT: mm

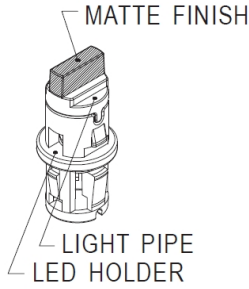
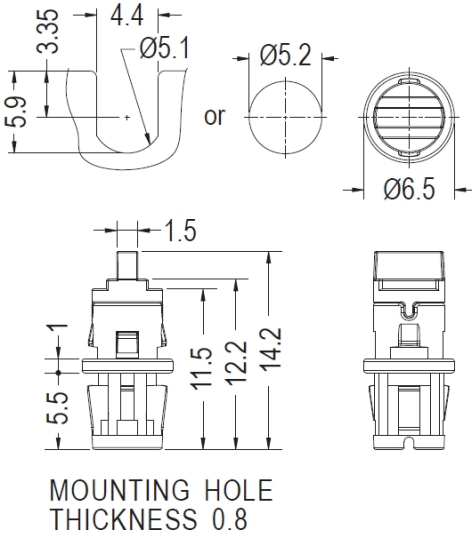

适用 ϕ 3mm的LED

适用2PIN/3PIN

PART NO	Part NO.	PACKAGE
LEDLP-239	LEDLP-239-1	1000
	LEDLP-239-2	
	上述零件可以单订订购	

MATERIAL : NYLON 66(UL)

FLAME CLASS : 94V-2

COLOR : BLACK

UNIT: mm

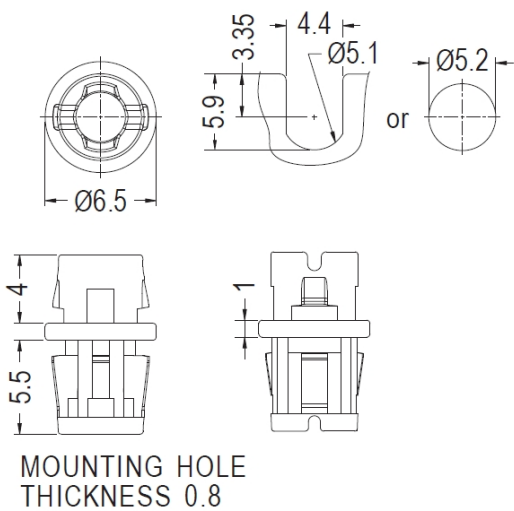

MATERIAL : PC(UL)

FLAME CLASS : 94V-2

COLOR : TRANSPARENT

UNIT: mm

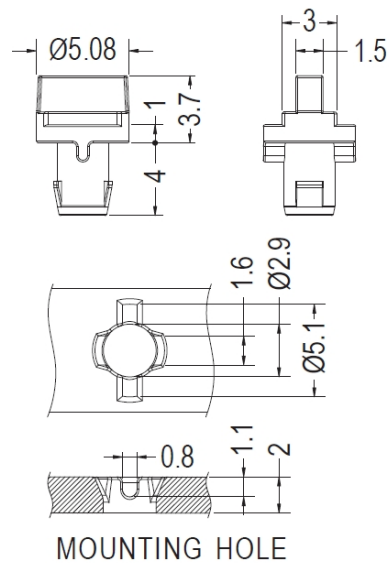

PART NO	PACKAGE
LEDLP-239-1	1000

PART NO	PACKAGE
LEDLP-239-2	1000

LEDLP-239使用说明书见样本最后页面

LED导光柱 LEDLP-239 使用说明

导光柱使用示意图

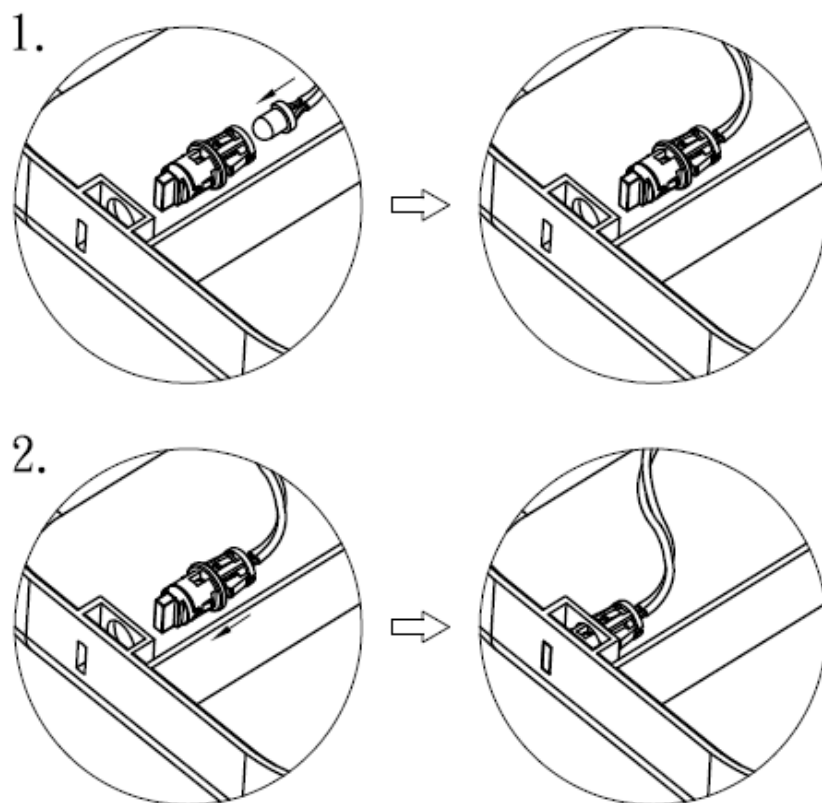
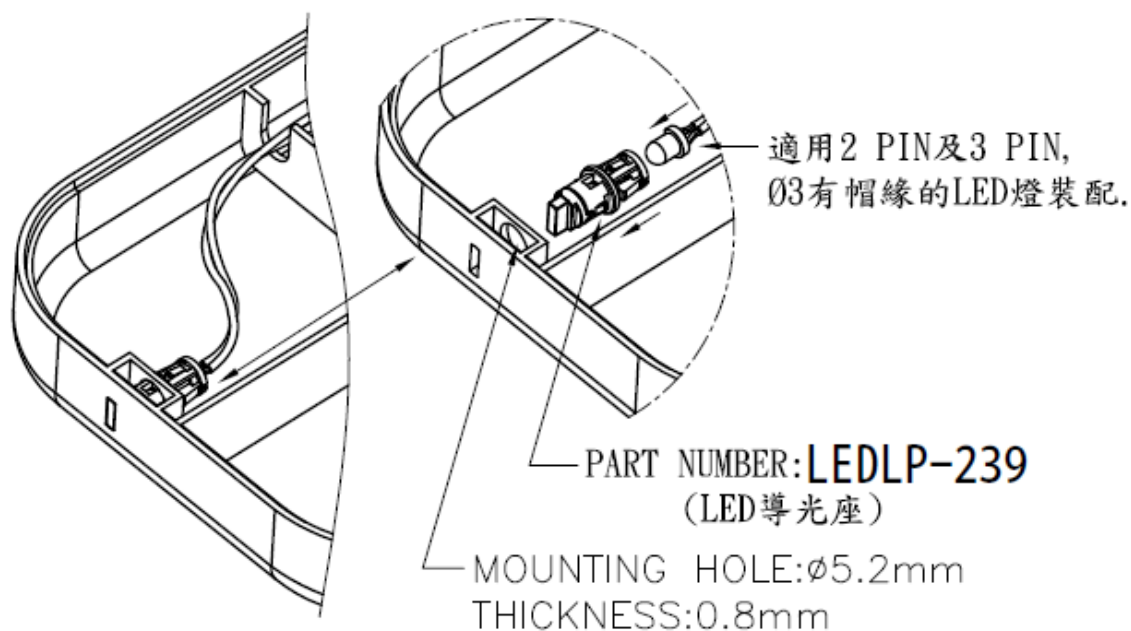

电子电脑塑胶五金零件目录

- 1.LED间隔柱
- 2.LED导光柱 LED导光盖 LED遮光罩
- 3.LED座 LED座套 红外线灯罩 光纤座
- 4.90°LED灯座 45°LED灯座
5. PC板间隔柱 PC板隔离柱
6. 塑料铜柱 尼龙柱 六角隔离柱 塑胶铜柱 铜柱 导光板隔离柱 圆体间隔柱 PC板固定定座 固定扣 电路板隔离柱 导电隔离柱
7. 排线固定座 自粘式配线固定座 排线固定夹 压线板 电线固定座 扭线固定座 扭式固定环 扎线固定座 电源线固定座 电源线固定座插头固定扣 天线固定座 T8灯管固定座 风扇束线座 光纤固定座
8. PC板端子 接线插片端子 PC板焊接端子 接地片 圆形连接片 弹片 测试针 探针 测试点 保险丝座 保险丝盖 插式电线连接头 闭端端子 弹簧螺纹端子 压线帽 端子台 快速接线夹 跳线
9. 仪表脚垫 插销式脚垫 螺丝固定脚垫 脚垫 抗震脚垫 磁铁脚垫 橡胶脚垫 自粘脚垫 银框脚垫 金框脚垫 橡胶垫圈 橡胶华司 橡胶垫片 硅胶脚垫
10. 塑料螺丝 塑胶螺丝 翼型塑料螺丝 塑料螺帽 塑料螺帽 蝶形螺母 止付螺丝 紧定螺钉 内牙螺丝 螺丝帽盖 手转螺丝 手拧螺丝 滚花螺丝 手转螺母 手拧螺母
11. PC板拉柄 PC板耳把 PC板导槽 电路板导轨 PCB导轨槽 直立式导槽 电路板导轨
12. 晶体管盖 电晶体盖 晶体管垫片 电晶体垫片 晶体管座 电晶体座 T-O3晶体管座 石英晶体垫片 垫圈 华司 垫片 TO-220晶体管座 光电晶体座 电晶体座 IR晶体座 霍尔晶体座 硅胶帽套 功率晶体导热硅片 功率晶体压板 电源固定压条 晶体管固定弹片 五金弹片 电晶体固定弹片 晶体管夹

电子电脑塑胶五金零件目录

13.电容器垫片 垫圈 华司 电容器座 电容器帽套 电容器固定座 电容器盖 电容器护套 压敏护套 硅胶帽套

14.热敏电阻座 电阻保护座 保护电阻器 可变电阻盖

15.陶瓷零件垫片 零件垫片 垫圈 华司 零件垫座 IC座 桥式整流座 跳线座 线圈座 滤波器垫片 绝缘柱 螺丝垫片 滚轮 PC板垫片 球击缓冲垫片 尼龙垫圈 尼龙弹簧垫片 散热陶瓷垫片

16.功率IC盖 桥式整流盖 保护盖 开关盖 硅胶盖 绝缘盖 电池盖 末端套管 软质端子保护套PC端子保护套 喇叭座 拉柄箱扣 线圈固定座 DRAM固定带 十字型插件式固定器 轨道固定器

17.孔塞 扣式孔塞 扣式塞头 DVI防尘盖 螺丝孔孔塞 螺丝塞头 螺纹孔塞

18.电源线扣 电线固定夹 护线环 橡胶圈 护线圈 开口式护线环 橡胶线环 硅胶线环 硅胶护线环 天线护线环 方型护线环 U型护线环 抗震护线环 防震线环 抗震线环用插销 抗震线环用螺丝 硬盘驱动器防震座 透气压力平衡固定头 透气平衡压力固定扣

19.把手 机箱把手 仪器门拉手 纸箱把手 纸箱配件 打包扣 外箱护脚垫 纸箱外箱扣

20.阻尼齿轮 阻尼器 缓冲齿轮

21.电线扎带 电线束线带 固定带 扎线 电源线收线带 珠型扎带 水管座 扎带座 扎带扣 吊勾粘扣带 绑线带

22.USB座护盖 USB端口保护盖 USB端口防尘盖 MICRO USB防尘盖 MINI USB座护盖USB Type-C防尘盖 USB防尘盖 RJ-45防尘盖 RJ-11防尘盖 RJ-12防尘盖 RJ-22防尘盖 电源插头防尘盖 电源插头保护座 电源插头防尘座 电源插头防尘盖 光纤连接器护盖 光纤连接器护套 光纤防尘盖 PC板金手指防尘盖 HDMI防尘盖 Mini数位端子防尘盖 汽车点烟器防尘盖BBU防尘盖 DVI防尘盖 连接器盖 SIM Card Cap防尘盖 SD防尘盖 KVM防尘盖 CF防尘盖 防尘盖 端子盖 S端子盖 平衡端子盖 BNC绝缘座 SATA防尘盖 ESATA护盖 DP端子防尘盖 Mini D.P数位端子防尘盖 D.Type防尘盖 VGA防尘盖 IDE Connector防尘盖 PC端子防尘盖 端子防尘盖 1394端子防尘盖 零件盖 电源盖 机板电源保护盖 连接器座 PCMIC卡保护盖 面板 DDR防尘盖 D-Sub保护盖 高压防尘盖 SD保护盖 Micoro SD卡保护盖 SIM卡保护盖 防水帽盖 帽盖连接带 防水圈 电脑风扇防护盖 电脑风扇防尘座 电脑风扇框护垫 电脑风扇支架 开关遮板 光纤晶体座

电子电脑塑胶五金零件目录

23.插销 铆钉 尼龙铆钉 螺丝铆钉 散热片铆钉 塑料铆钉 电脑风扇铆钉 散热片扣件 弹簧铆钉 螺丝固定座 膨胀螺栓 墙塞 无帽鱼型膨胀管 墙面固定座 石膏板固定座

24.固定扣 门扣开关 机器门扣开关 弹簧固定座 旋转型门扣 门扣碰珠 磁铁门扣

55.工具 线扣工具 进口束线枪 旗型端子工具 国产束线枪 非绝缘端子工具 绝缘端子工具



电子电脑塑胶五金零件目录



1.LED间隔柱



2.LED导光柱



3.LED座



4.90°LED灯座



5.PC板间隔柱



6.塑料铜柱



7.排线固定座



8.PC板端子



9.仪表脚垫



10.塑料螺丝



11.PC板拉柄导槽



12.晶体管盖



13.电容器垫片



14.热敏电阻座



15.陶瓷零件垫片



16.功率IC盖



电子电脑塑胶五金零件目录



17.孔塞



18.电源线扣



19.机箱把手



20.阻尼齿轮



21.电线扎带



22.USB座护盖

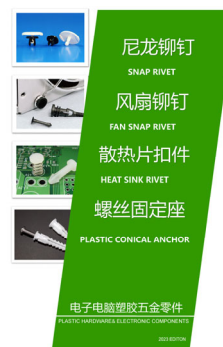

23.尼龙铆钉



24.门扣开关



55.工具

电子电脑塑胶五金零件

PLASTIC HARDWARE & ELECTRONIC COMPONENTS



南京诺金电气有限公司
Nanjing Nojing Electric Co., Ltd.

2021.02/17/18

选型手册总目录

本公司保留因质量改进、后续开发或生产要求引起的设计更改权力。本产品目录为元件的详细说明，不能做担保依据。使用者有义务审核该元件是否符合应用范围的规定。



微信



QQ

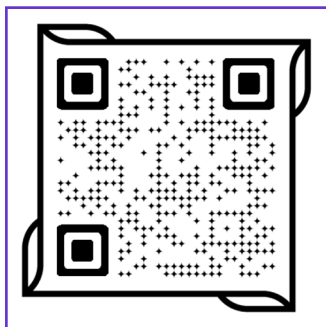

网站

南京诺金电气有限公司

Nanjing Nowking Electric Co., Ltd

- ◆ Tel: 025-85422485 85436028 85437901
- ◆ Wechat/Mobile :13770725488
- ◆ QQ:260678075
- ◆ E-mail: nk@nowking.com
- ◆ Http://www.nowking.com
- ◆ Http://www.kyphe.com